



*Meubles de Qualité à prix Abordable  
Affordable Quality Home Furniture*

ENSEMBLE BISTRO 3MCX MÉTAL BRONZE / MARBRE  
CAPPUCCINO

CAPPUCCINO MARBLE / BRONZE METAL 3PCS BISTRO  
SET

## I 3045

---

INSTRUCTIONS D'ASSEMBLAGE  
ASSEMBLY INSTRUCTIONS

MONARCH SPECIALTIES INC.



POUR DE L'ASSISTANCE OU POUR COMMANDER  
DES PIÈCES CONTACTEZ NOTRE DÉPARTEMENT  
DE SERVICE À LA CLIENTÈLE.







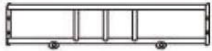

FOR ASSISTANCE OR TO ORDER PARTS  
CONTACT OUR CUSTOMER SERVICE DEPARTMENT

**[WWW.MONARCHSERVICE.COM](http://WWW.MONARCHSERVICE.COM)**

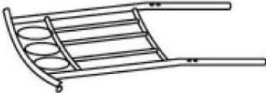







---

## IDENTIFICATION DES PIÈCES

### PARTS IDENTIFICATION

1		DESSUS DE TABLE TABLE TOP	1MC/PC
2		SOUTIEN DE PATTE LEG SUPPORT	2MCX/PCS
3		PATTE LEG	2MCX/PCS
4		DOSSIER BACK	2MCX/PCS
5		PATTE DE CHAISE GAUCHE LEFT CHAIR LEG	2MCX/PCS
6		PATTE DE CHAISE DROITE RIGHT CHAIR LEG	2MCX/PCS
7		BARRE TRANSVERSALE DU SIÈGE SEAT CROSS BAR	2MCX/PCS
8		BARRE TRANSVERSALE DE PATTE (CHAISE) CROSS BAR (CHAIR)	2MCX/PCS
9		BARRE TRANSVERSALE DE PATTE (CHAISE) CROSS BAR (CHAIR)	2MCX/PCS
10		SIÈGE COUSSINÉ CUSHION SEAT	2MCX/PCS

IDENTIFICATION DES PIÈCES DE MONTAGE  
HARDWARE IDENTIFICATION

A		Ø4" X32MM	8MCX/PCS
B		Ø 1/4" X 12MM	20MCX/PCS
C		Ø 1/4" X35MM	8MCX/PCS
D		Ø4" X 12MM	4MCX/PCS
E		Ø 1/4" X15MM	2MCX/PCS
F		ÉCROU HEXAGONALE 1/4 " HEX NUT 1/4 "	2MCX/PCS
G		CLÉ OUVERTE SPANNER	1MC/PC
H		CLÉ HEXAGONALE (4MM) ALLEN KEY (4MM)	1MC/PC

ÉTAPE / STEP 1

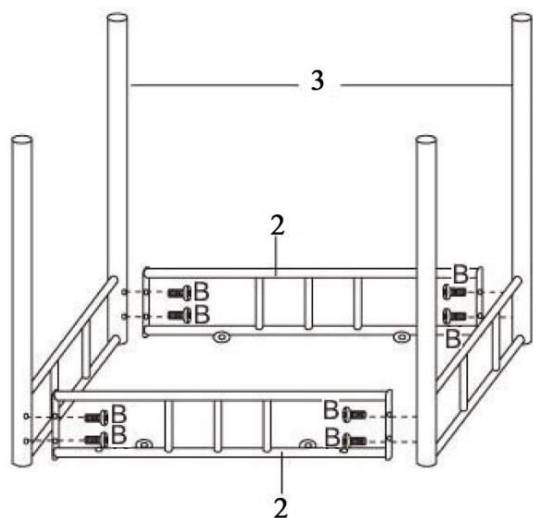

ÉTAPE / STEP 2

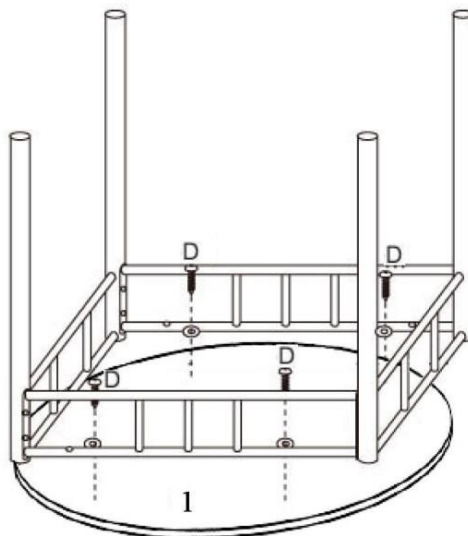

ÉTAPE / STEP 3

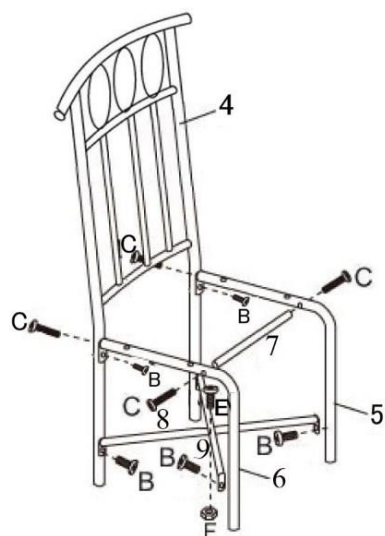

ÉTAPE / STEP 4

