

JVW5301SJ/EJ/BJ/FJ

GE® 30" Wall-Mount Pyramid Chimney Hood

DIMENSIONS AND INSTALLATION INFORMATION (IN INCHES)

INSTALLATION INFORMATION:

Before installing, consult Use & Care/installation instructions packed with product for current dimensional data.

OPTIONAL ACCESSORIES

UXDC72SJSS/FJDS/BJTS – 9(ft.) Ceiling Duct Cover Kit

UXDC53SJSS/EJES/BJTS/FJDS – 10(ft.) Ceiling Duct Cover Kit

For 30" distance from counter to hood:

Below 8'-4" ceiling height – no duct cover required

8'-4" – 9'-6" ceiling height – use UXDC72SJSS/FJDS/BJTS

Above 9'-7" ceiling height – use UXDC53SJSS/EJES/BJTS/FJDS

Refer to Installation Instructions for exact specifications

UXRC70 – Remote Control

JXCF72 – Charcoal Filter (needed if used in recirculation mode)

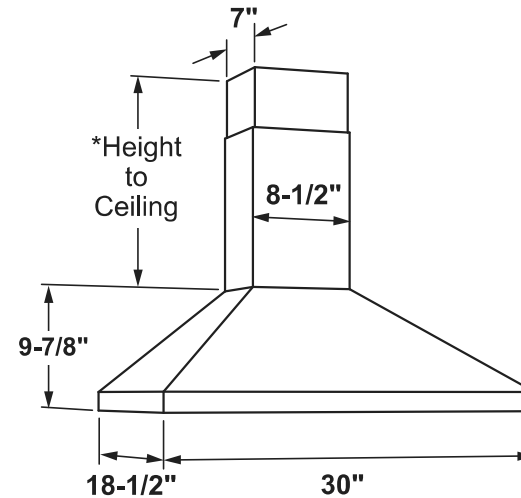

30" Models Require a 30"-Wide Opening

*The supplied duct cover fits 7'-4" to 9'-0" ceiling heights (10' with optional high ceiling kit UXDC53)

AMP RATING	
120V	2.5

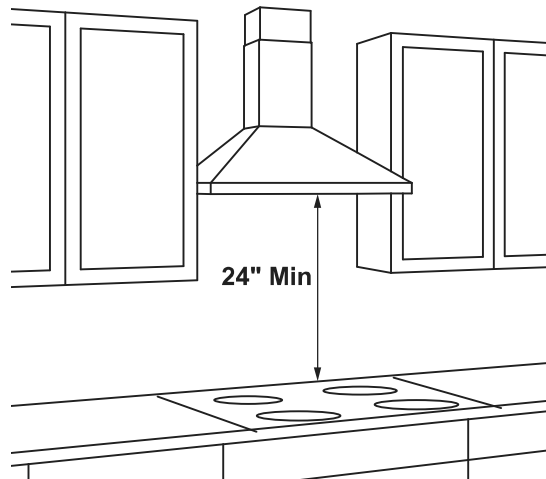

The vent hood must be installed 24" min. above the cooking surface. For optimal performance, installing the hood more than 38" above the cooking surface is not recommended. The hood installation height above the cooking surface depends upon ceiling height. The telescopic duct cover conceals the ductwork running from the top of the hood to the ceiling.

NOTE: Installation height should be measured from the cooking surface to the lowest part of the hood. This hood may be installed onto a wall and vented to the outdoors, or it can be installed for recirculating operation. Parts for recirculating operation are supplied with the hood. However, when installed for recirculating operation, the optional charcoal Filter JXCF72 will need to be purchased separately.



For answers to your GE Profile™ Series or GE Appliances product questions, visit our website at geappliances.com or call GE Answer Center® Service, 800.626.2000.



Specification Revised 01/20

JVW5301SJ/EJ/BJ/FJ

GE® 30" Wall-Mount Pyramid Chimney Hood

FEATURES AND BENEFITS

350-CFM venting system with boost – Effectively remove smoke, grease, odor and moisture

Electronic backlit controls – Add a sophisticated look with this up-front, easy-to-use display

Dual halogen cooktop light – Enjoy better visibility with a brightly lit cooktop and surrounding surface

Night light – Keep a dim light on for visibility at all hours

Convertible venting options – Select recirculating or external venting

Remote control option – Control your ventilation lighting and fan speed from anywhere in the kitchen

Model JVW5301SJSS – Stainless steel

Model JVW5301EJES – Slate

Model JVW5301BJTS – Black stainless

Model JVW5301FJDS – Black slate

