



**INSTRUCTIONS D'ASSEMBLAGE**  
**ASSEMBLY INSTRUCTIONS**

---

**M**ONARCH  
SPECIALTIES INC.

# I 1114

---

**CHAISE -**  
**2PCS / 39" H / TISSU TAUPE / METAL NOIR**

**DINING CHAIR -**  
**2PCS / 39" H / TAUPE FABRIC / BLACK METAL**





**POUR DE L'ASSISTANCE OU POUR COMMANDER  
DES PIÈCES CONTACTEZ NOTRE DÉPARTEMENT  
DE SERVICE À LA CLIENTÈLE.**

**FOR ASSISTANCE OR TO ORDER PARTS  
CONTACT OUR CUSTOMER SERVICE DEPARTMENT**

**WWW.MONARCHSERVICE.COM**

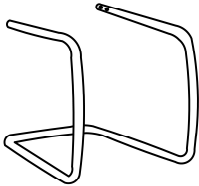
**LISTE DES PIÈCES**  
**PARTS LIST**

PIÈCE / PART #	IMAGE	DESCRIPTION	QTY / QTÉ
1		<p>BACK DOSSIER</p>	2
2		<p>CHAIR LEG PATTE DE CHAISE</p>	2
3		<p>SEAT CUSHION COUSSIN DU SIÈGE</p>	2

**LISTE DES PIÈCES DE MONTAGE**  
**HARDWARE LIST**

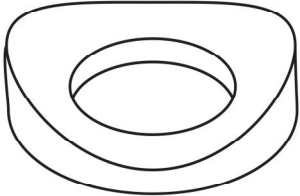
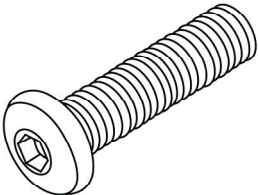
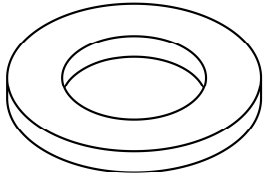
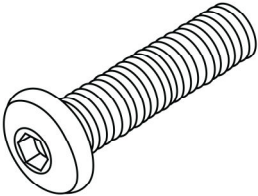
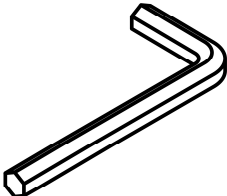
PIÈCE / PART #	IMAGE	DESCRIPTION	QTY / QTÉ
A		CURVED WASHER - Ø7/8" RONDELLE CURVÉE - Ø7/8"	8
B		ASSEMBLING BOLT - Ø 3/8" X 3/4" BOULON D'ASSEMBLAGE - Ø 3/8" X 3/4"	8
C		METAL WASHER - Ø 3/4" RONDELLE DE MÉTAL - Ø 3/4"	8
D		ASSEMBLING BOLT - Ø 1/4" X 3/4" BOULON D'ASSEMBLAGE - Ø 1/4" X 3/4"	8
E		HEX KEY CLÉ HEXAGONALE	2



OUTIL DE VÉRIFICATION DE DIMENSIONS DES PIÈCES  
HARDWARE DIMENSIONS VERIFICATION TOOL



ÉTAPE / STEP 1

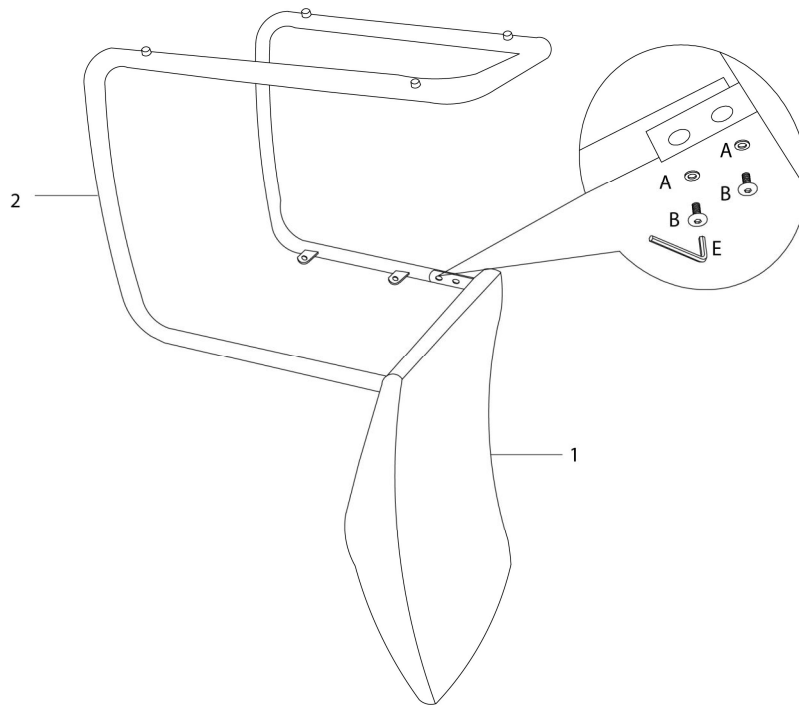

ÉTAPE / STEP 2

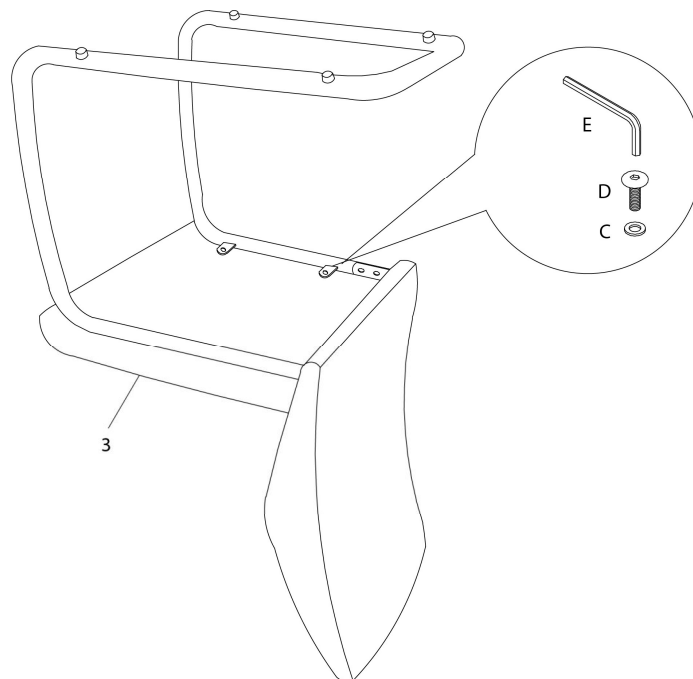

ÉTAPE / STEP 3

