

SOJAG

produits saisonniers • seasonal products



QUESTIONS? 1 866-901-1649

Sojag code: _____

Assembly Manual / Guide d'assemblage / Manual de ensamblaje / 조립설명서 / Montageanleitung

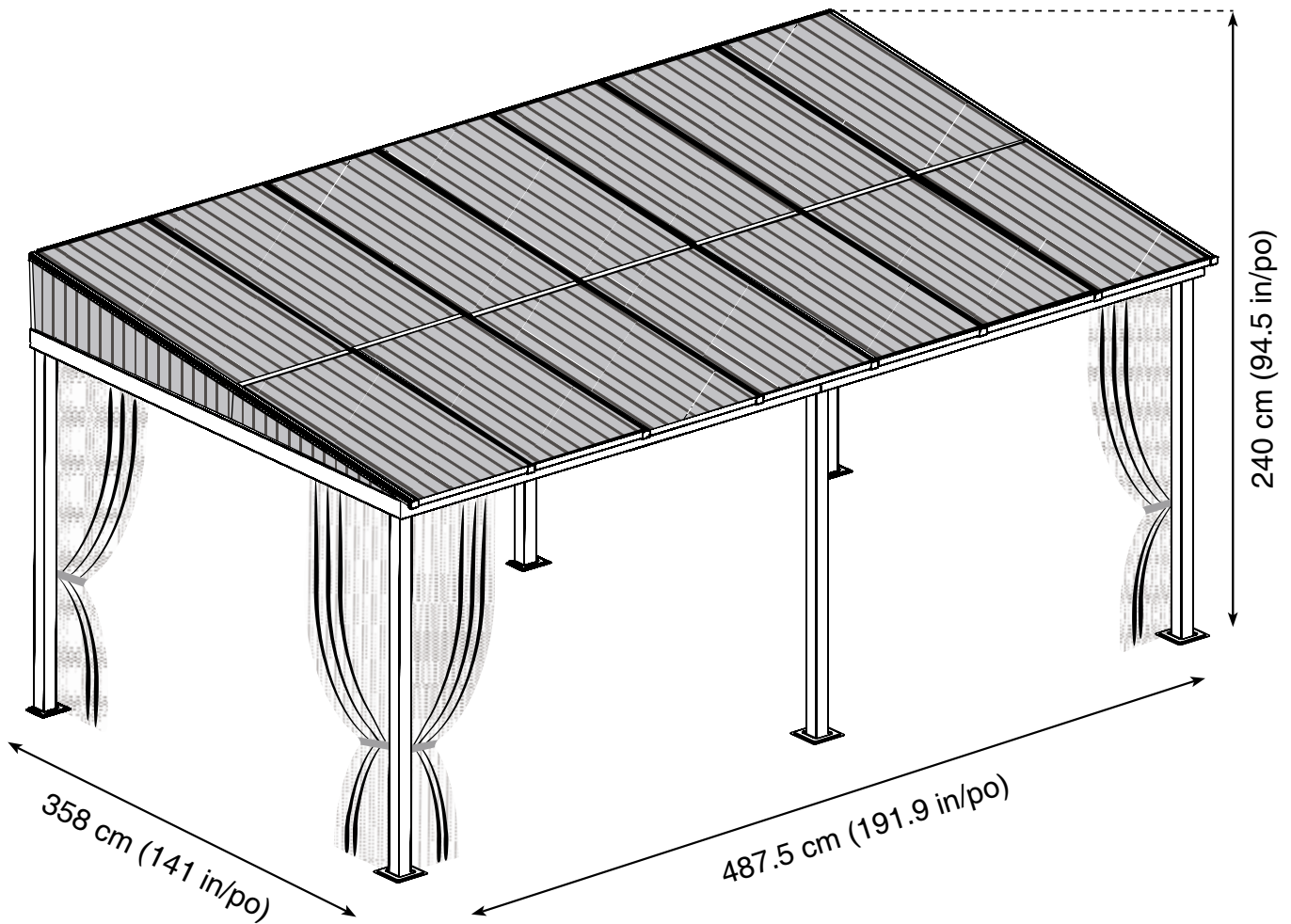



Use the hex keys in the box. / Utilisez les clés hexagonales fournies dans la boîte. / Utilice las llaves hexagonales en la caja. / 상자에 육각 키를 사용 하십시오. / Verwenden Sie die Sechskantschlüssel in der Box.

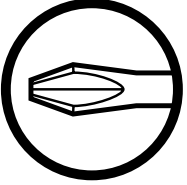

Please use a Phillips screwdriver / Utilisez un tournevis de type Phillips / Por favor, use un destornillador Phillips / 십자 드라이버를 사용 하십시오. / Bitte verwenden Sie einen Kreuzschraubenzieher.



you may need to use a drill for this step. / Vous pouvez avoir besoin d'utiliser une perceuse pour cette étape. / puede que tenga que utilizar un taladro para este paso. / 이 단계에선 드릴을 사용해야 할 수도 있습니다. / Für diesen Schritt können Sie einen Bohrer verwenden.



Wearing protective gloves is recommended. / Le port de gants de protection est recommandé / El uso de guantes de protección se recomienda / 보호 장갑을 착용 하는 것이 좋습니다. / Das Tragen von Schutzhandschuhen wird empfohlen.



Two or more people are required at this stage. / Deux personnes ou plus sont nécessaires à cette étape. / Dos o más personas se requieren en esta etapa. / 이 단계에서는 두 명 이상이 필요합니다. / Für diesen Bauschritt sind 2 oder mehr Personen erforderlich.



Do not screw firmly for now. / Ne pas visser fermement pour l'instant. / No atornille con firmeza por ahora. / 아직 나사를 단단히 조이지 마십시오. / Bitte die Schrauben zum jetzigen Zeitpunkt noch nicht fest anziehen.



Sold separately / Vendus séparément / vendido en las opciones / 옵션 판매 / Optional erhältlich

U X 4 (+1)

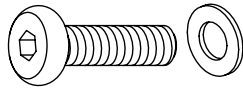

V X 153 (+10)

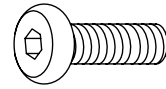

W X 12 (+2)

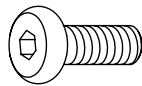

W1 X 40 (+2)

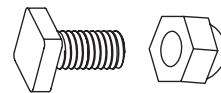

W3 X 8 (+2)

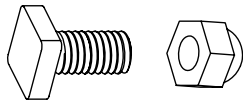

X X 40 (+3)

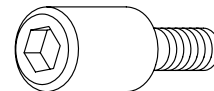

Z X 1

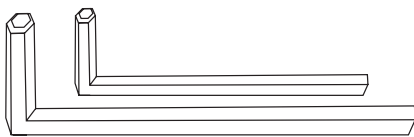



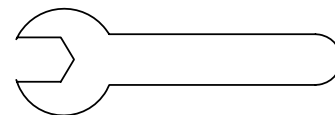

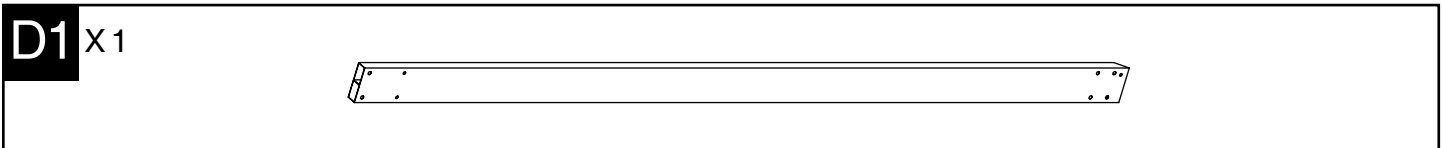
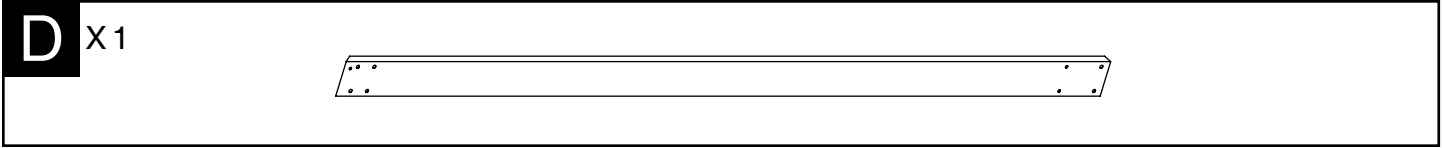
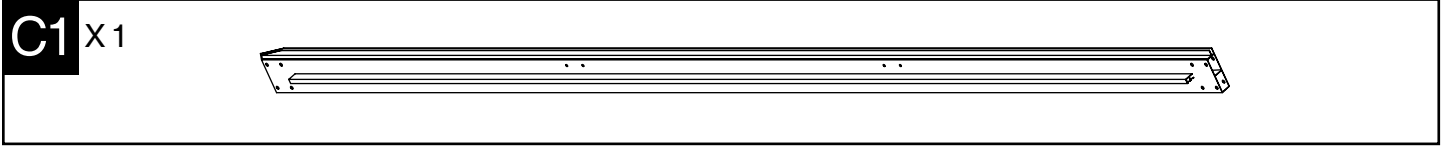
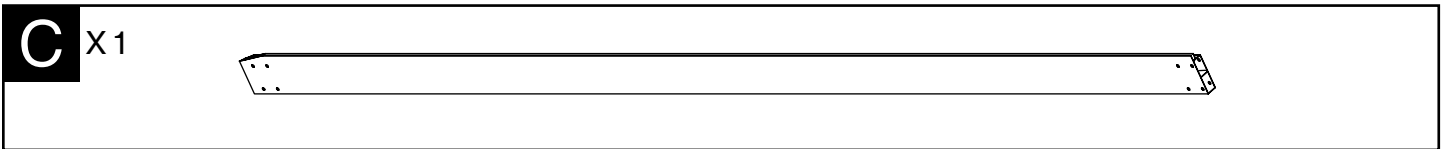
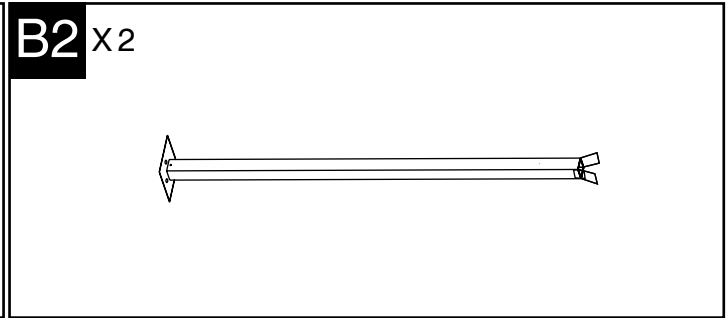
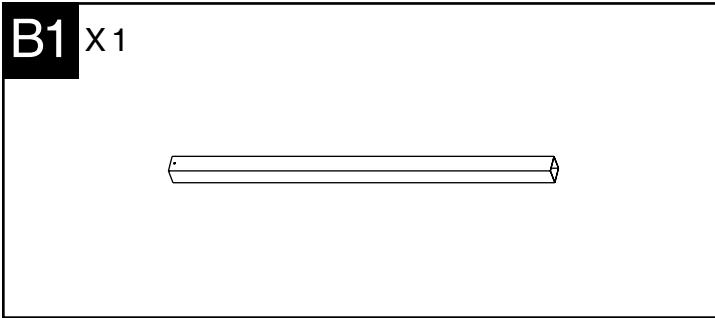
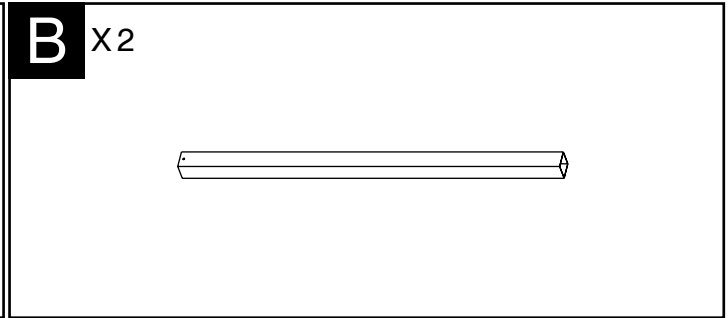
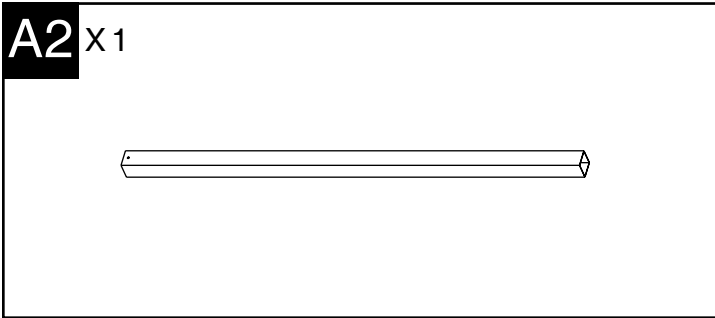
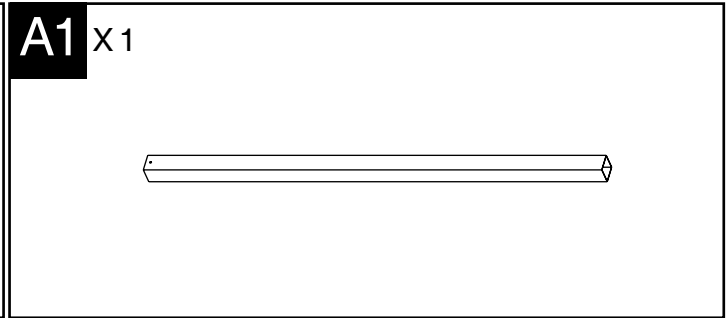
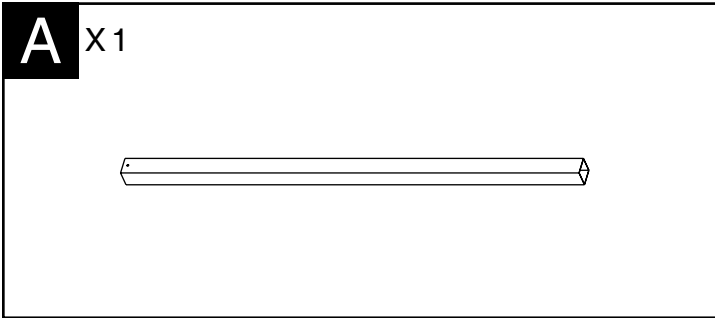

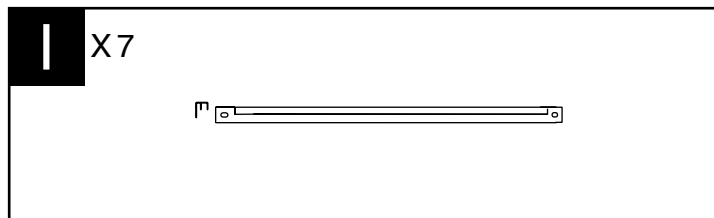
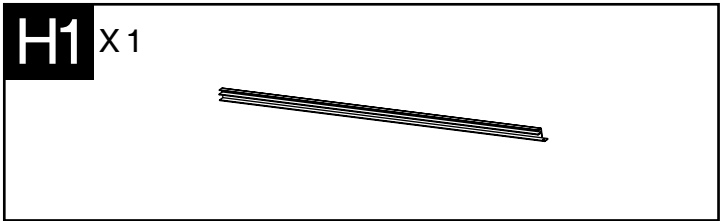
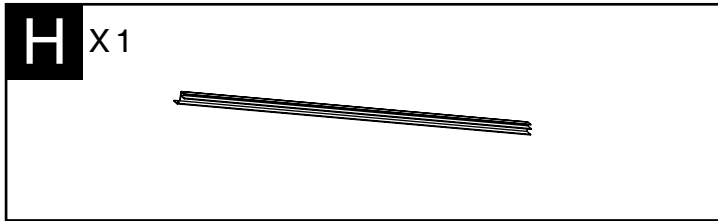
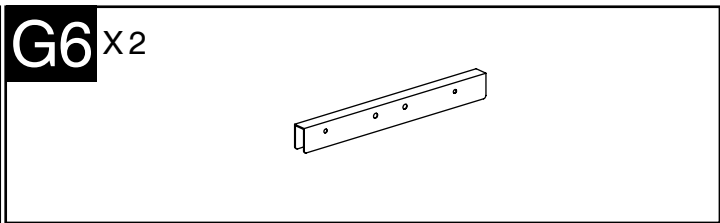
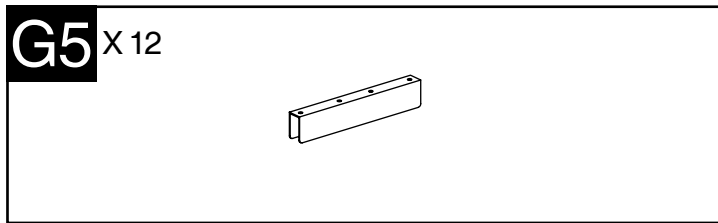
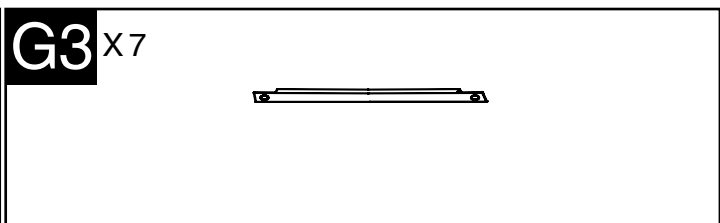
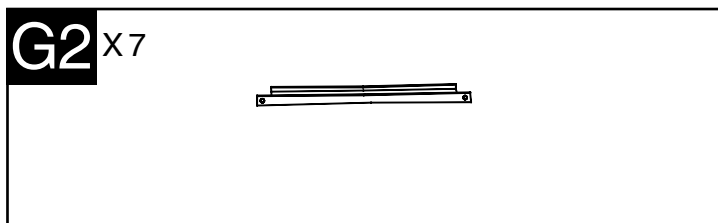
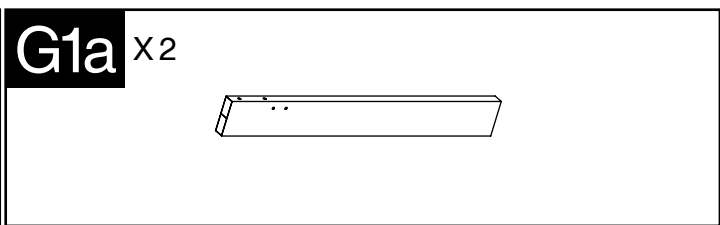
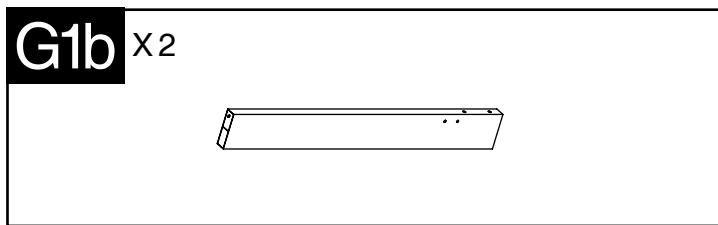
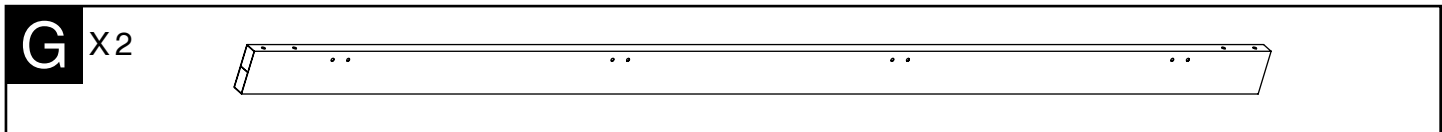
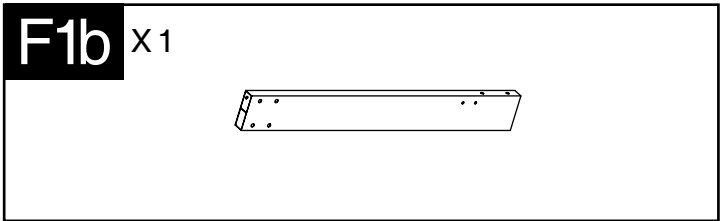
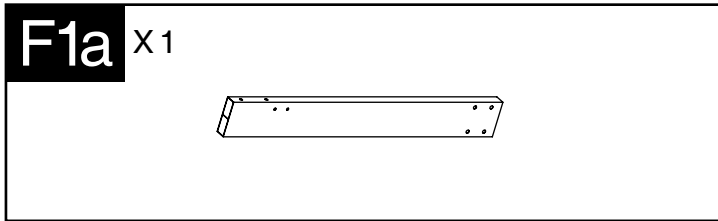

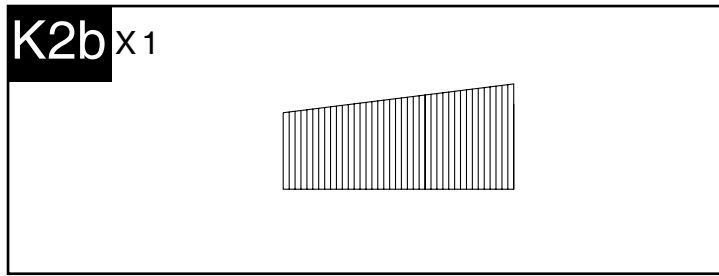
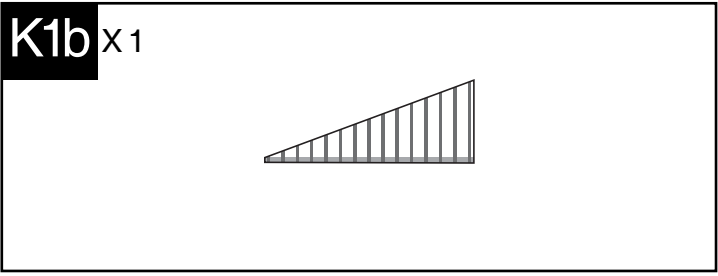
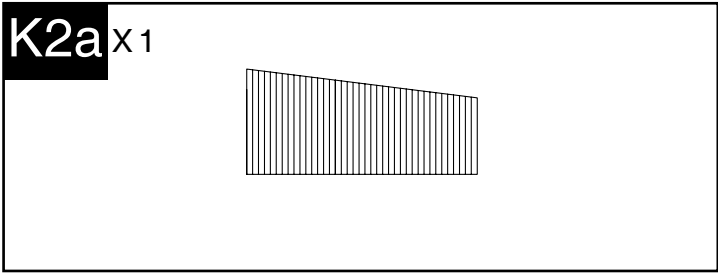
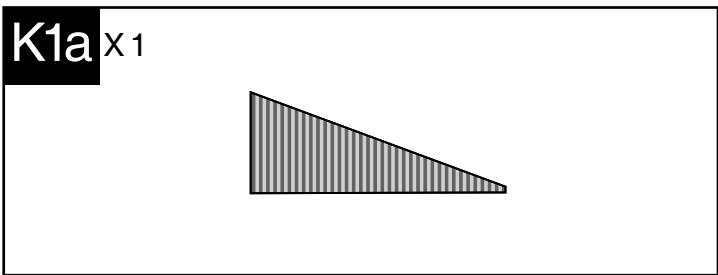
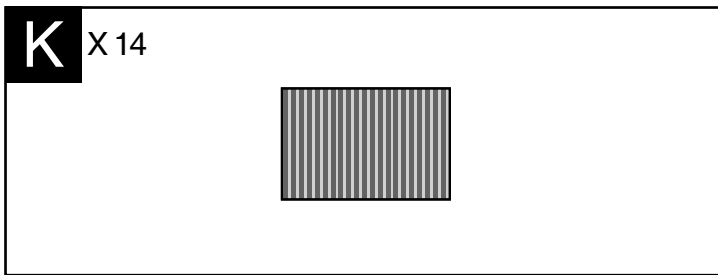
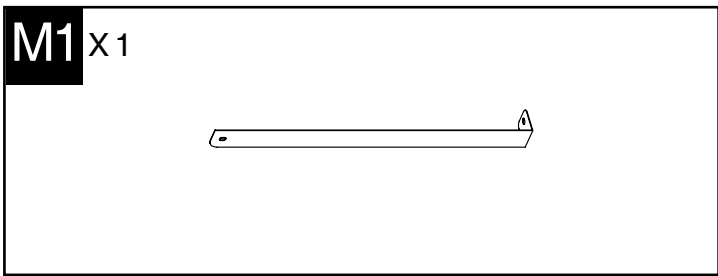
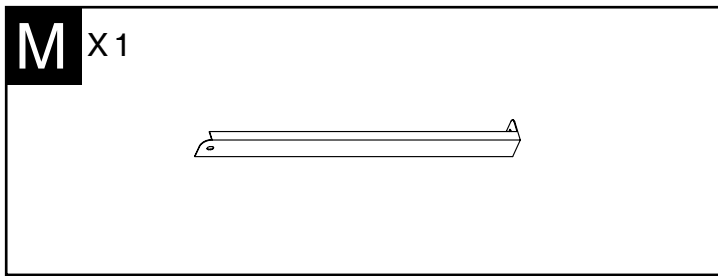
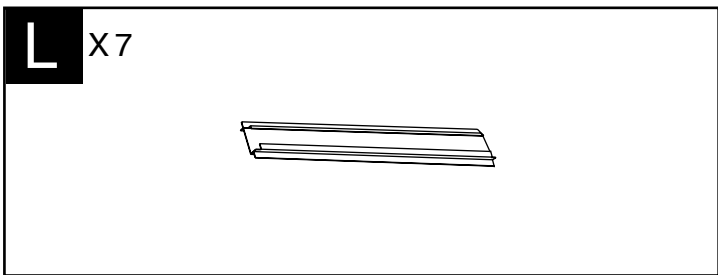
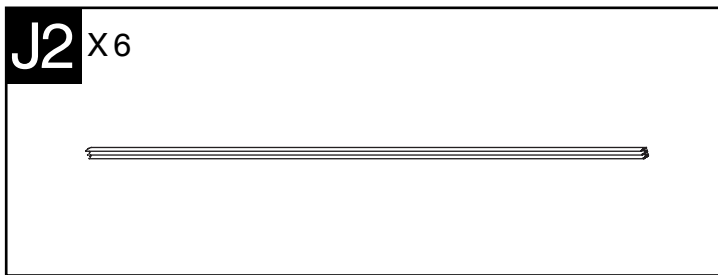
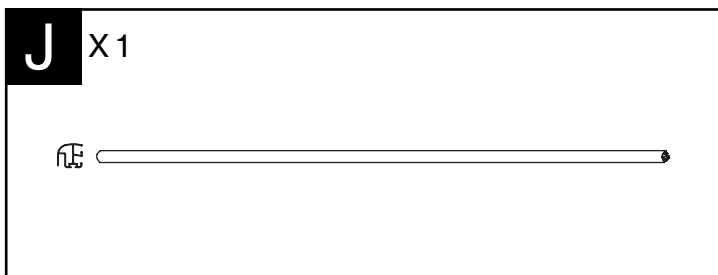

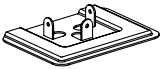

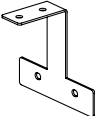

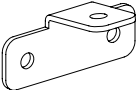

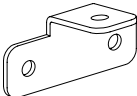
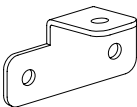
Z1 X 1



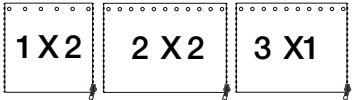



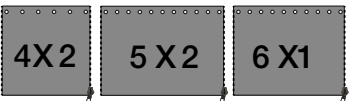

N X3 	N1 X4 
N2 X3 	O X2 
O1 X2 	P X16 
P1 X8 	P2 X4 
P3 X4 	Q2 X8 
RR X 48 (+2)   optional	Net   optional
RR X 48 (+2)   optional	Curtain   optional

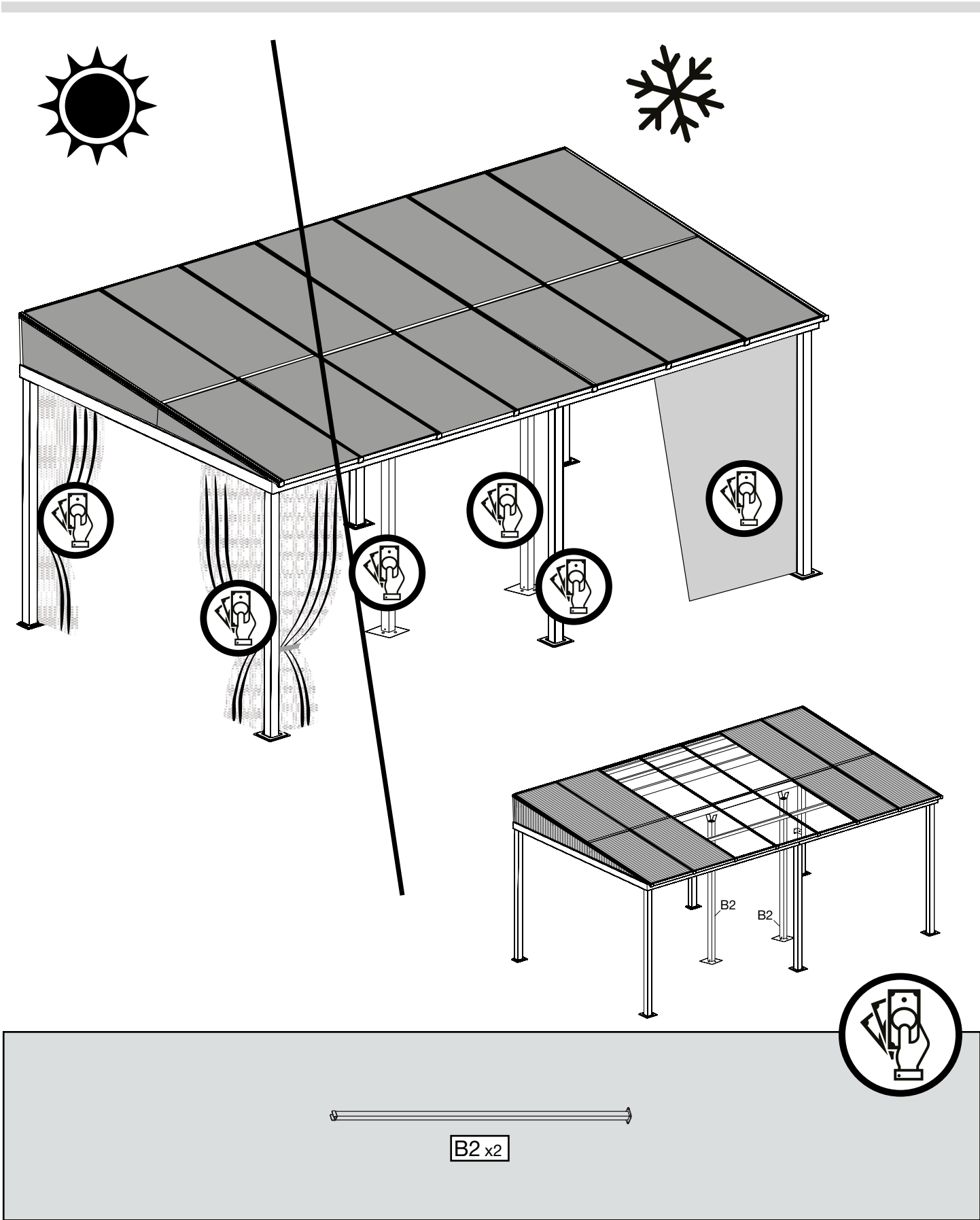

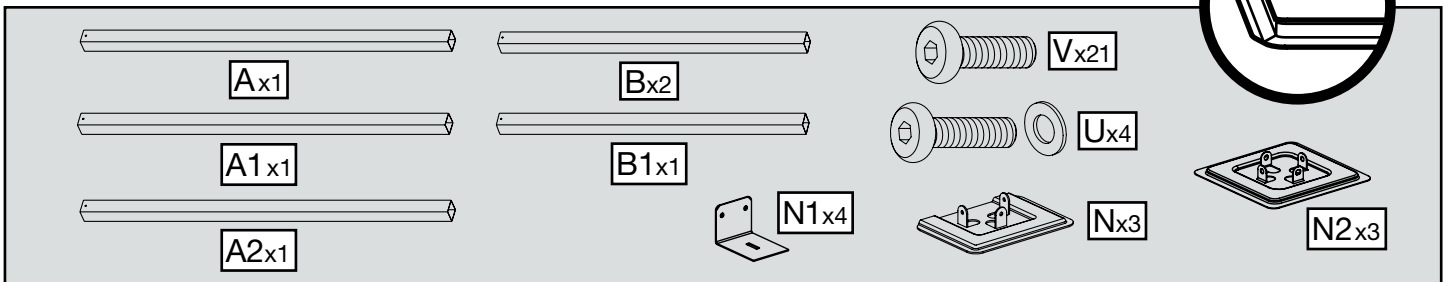
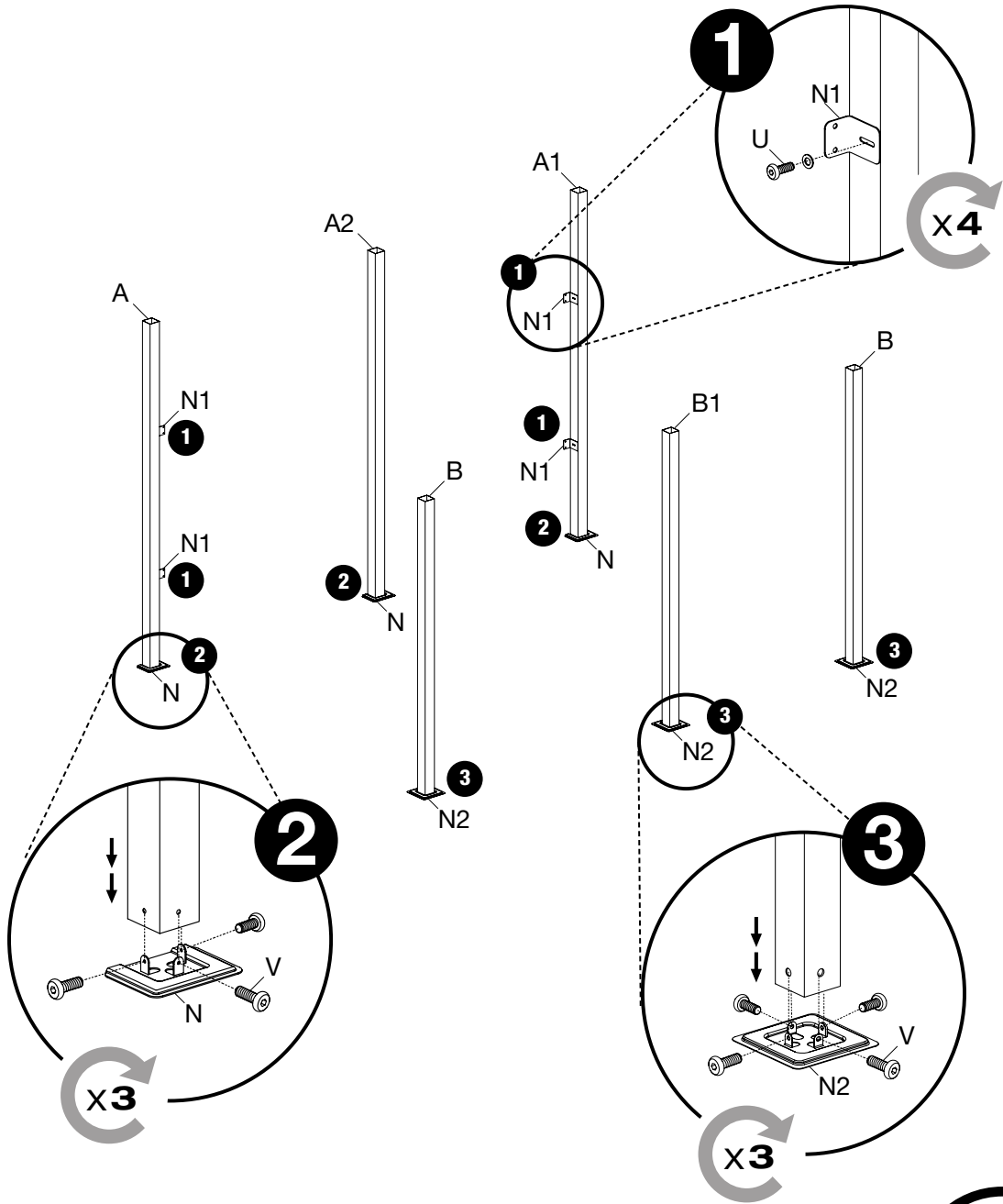

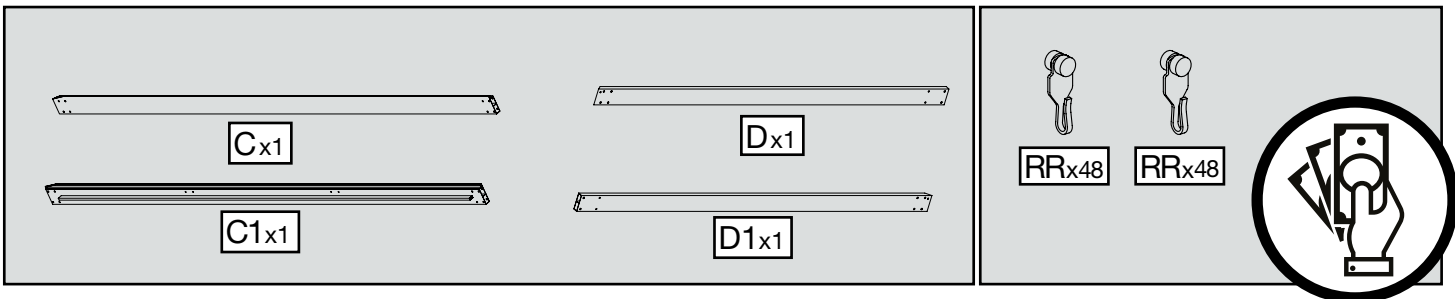
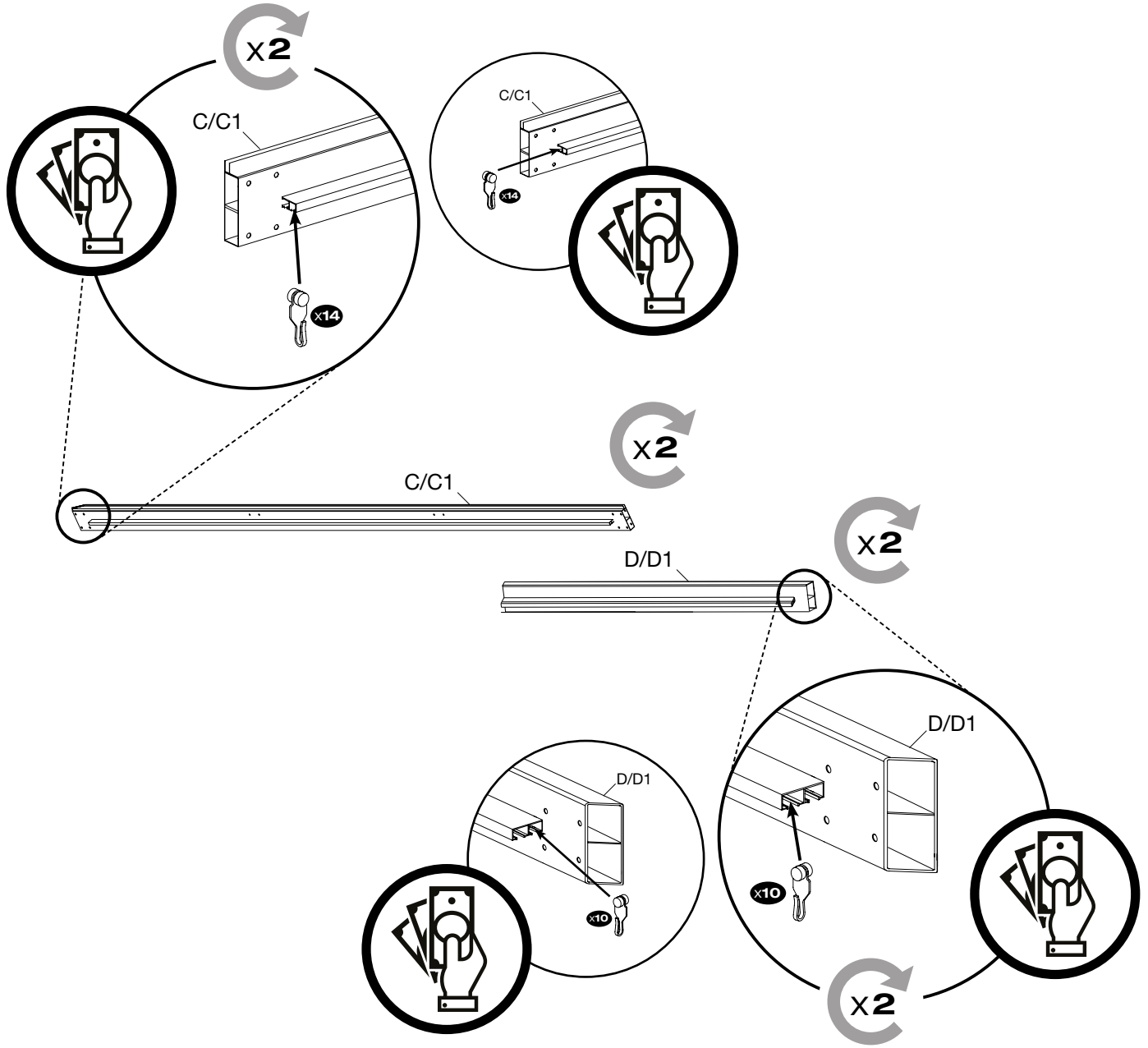

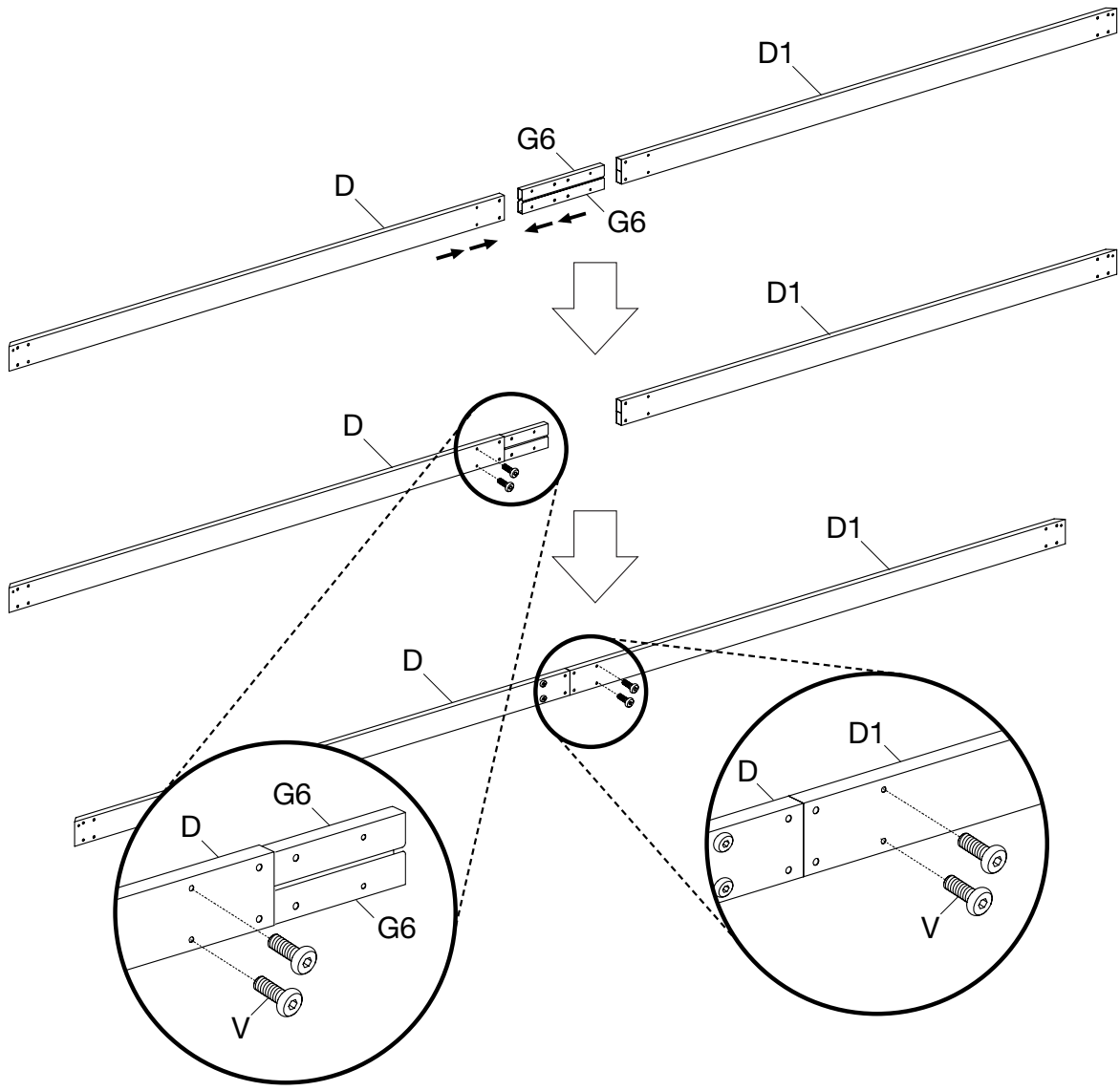

This section contains the parts list for the assembly. It includes a screw labeled **Vx4**, a bracket labeled **G6x2**, and a circular icon of a hex key.

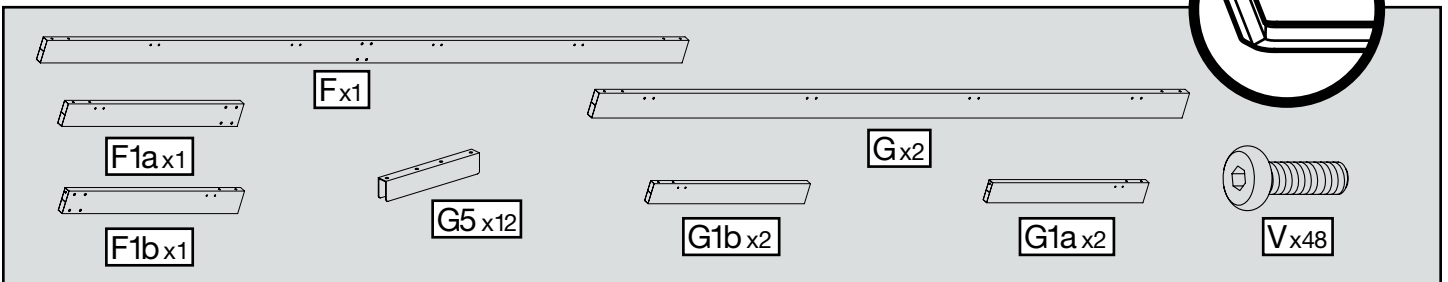
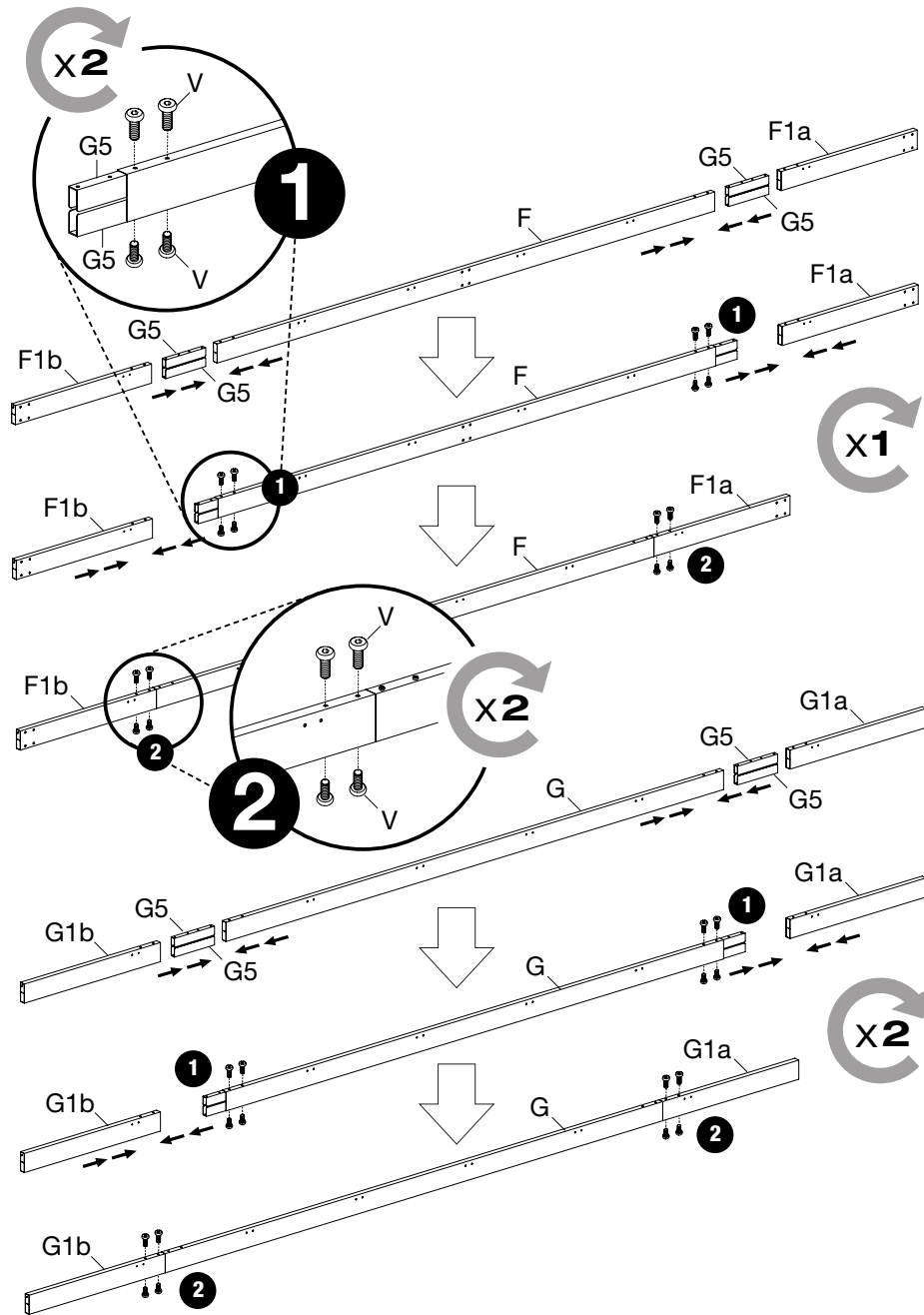

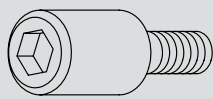
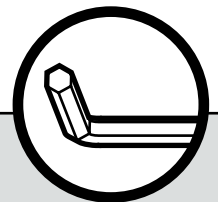
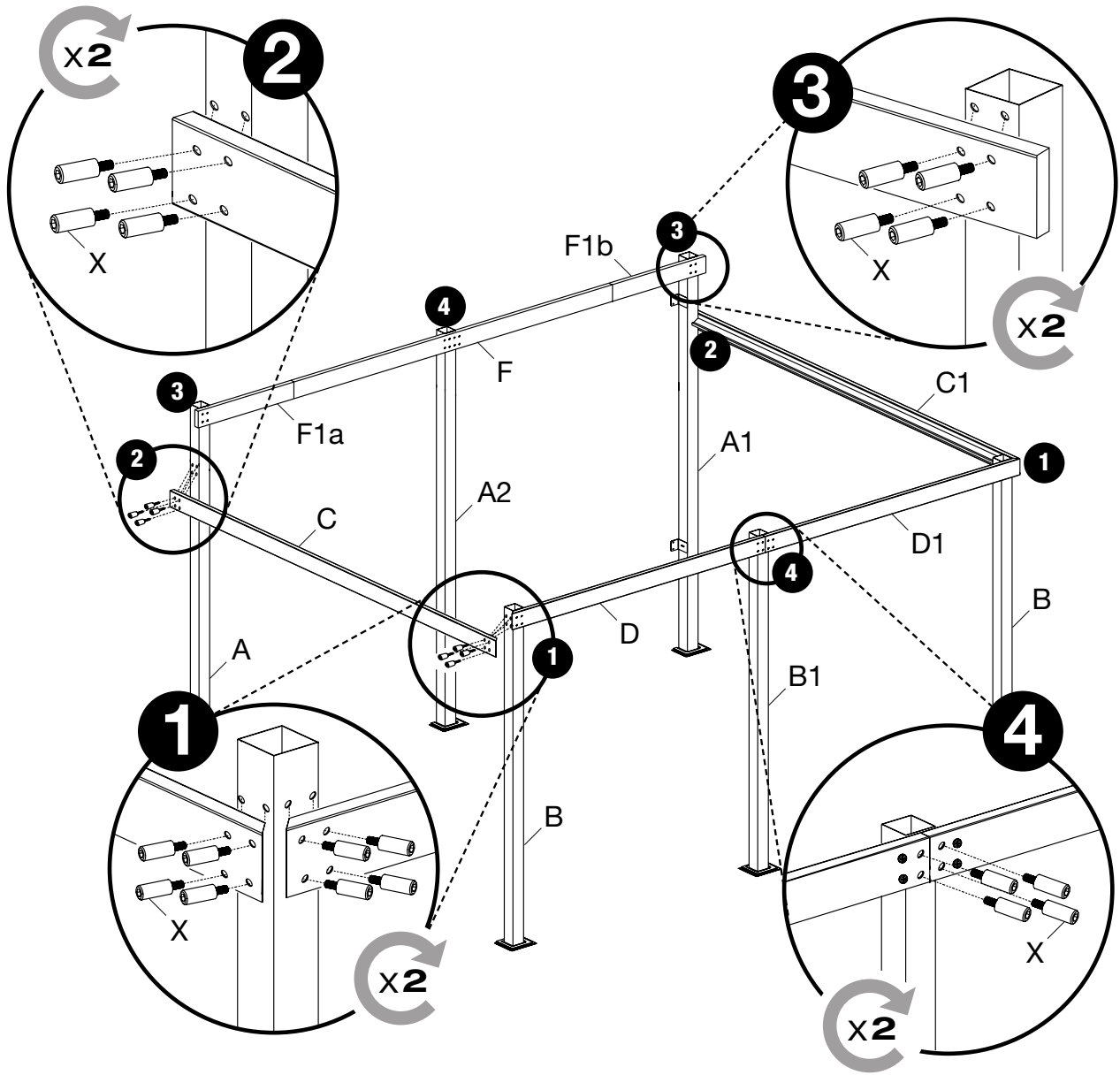

X x40

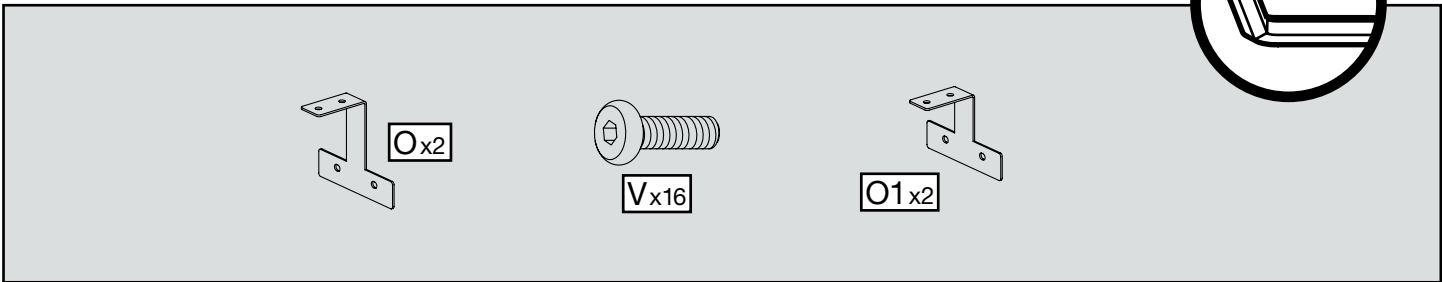
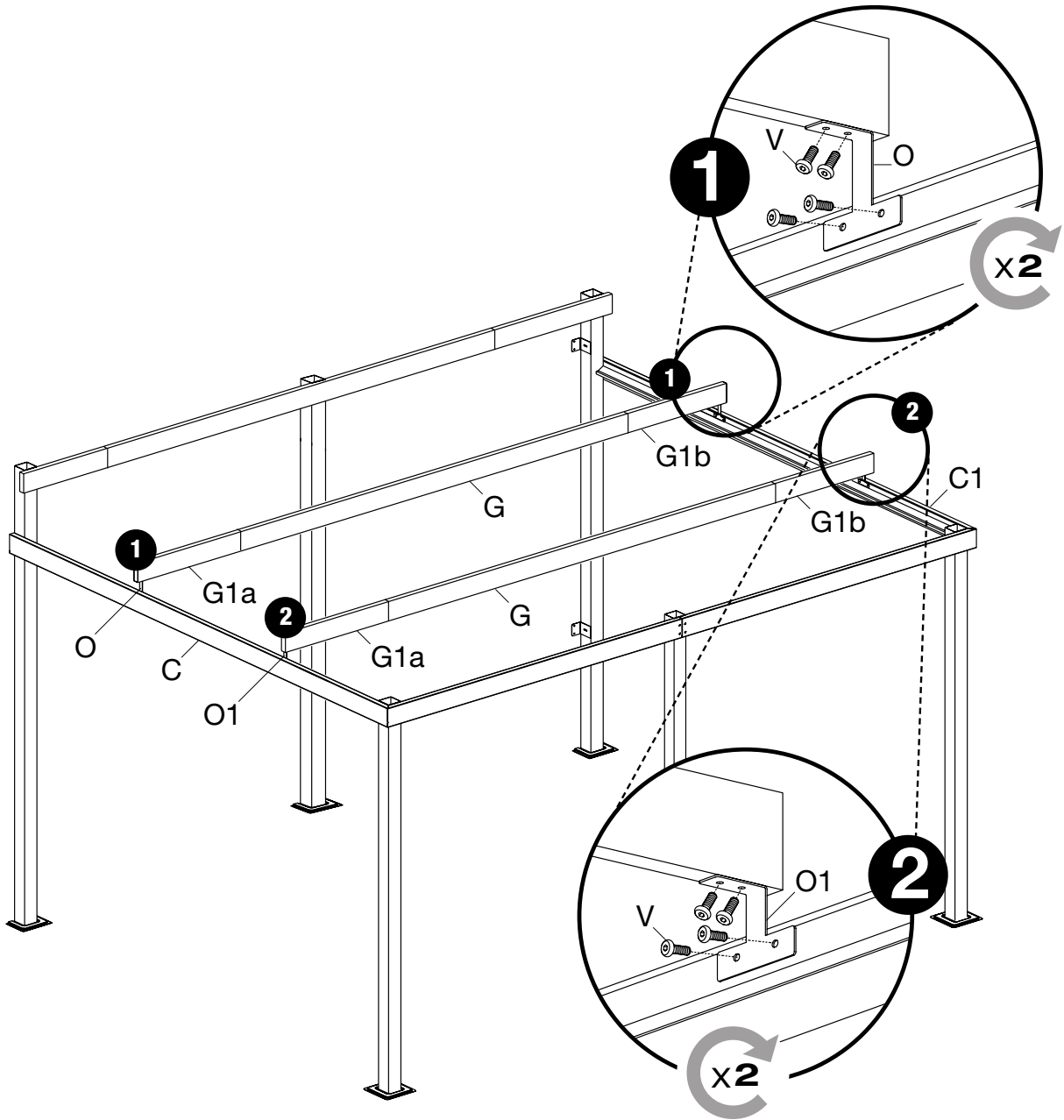

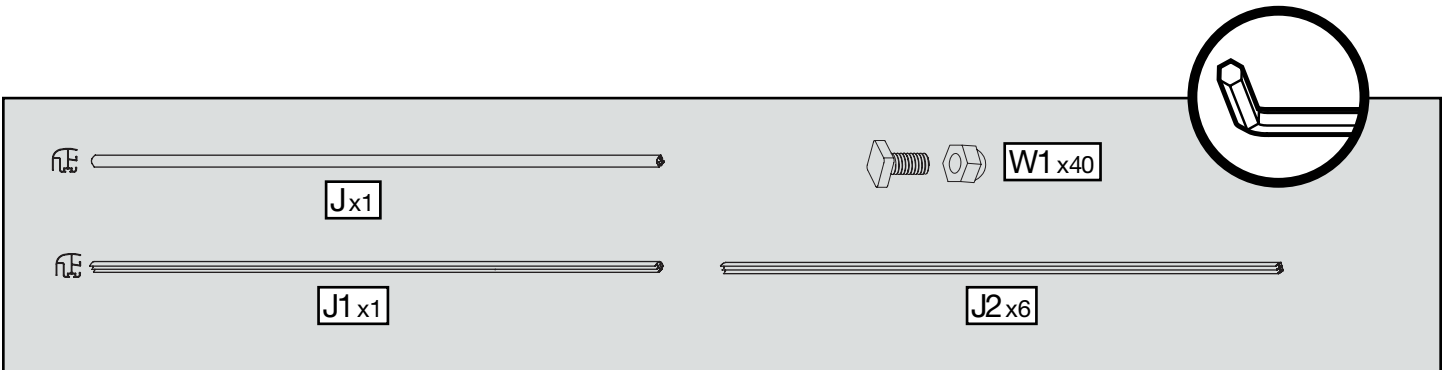
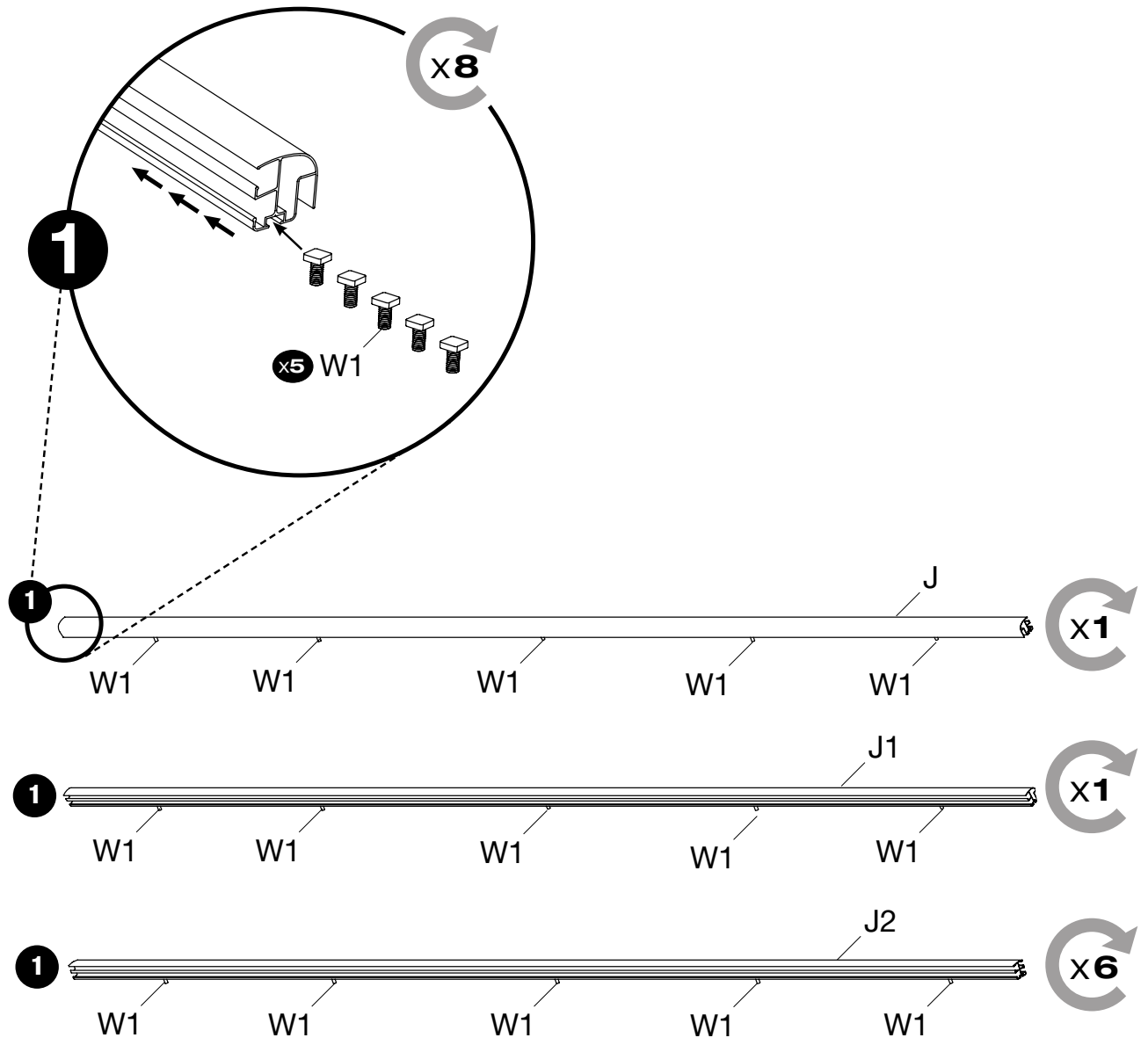

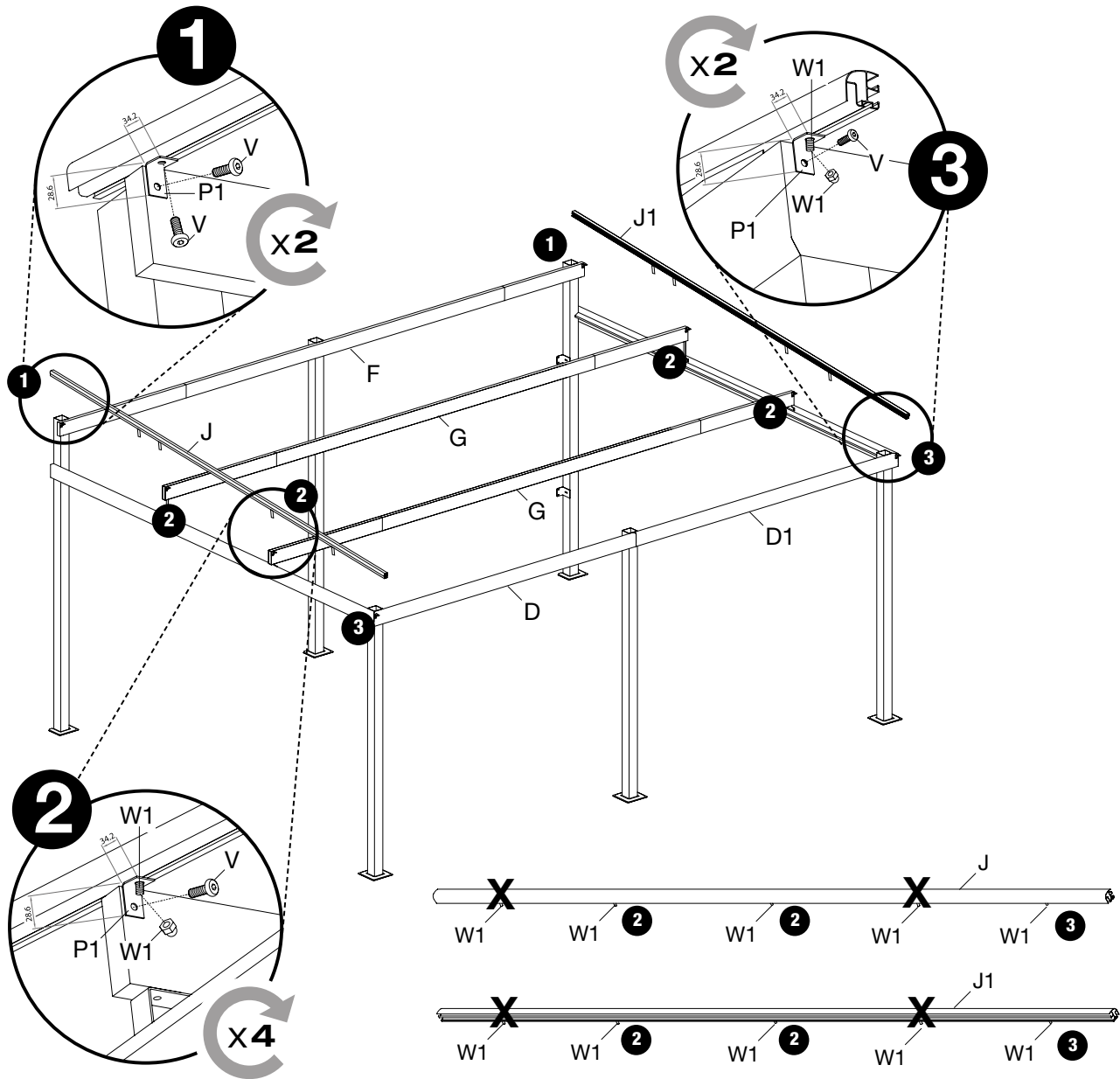

P1 x8

V x10

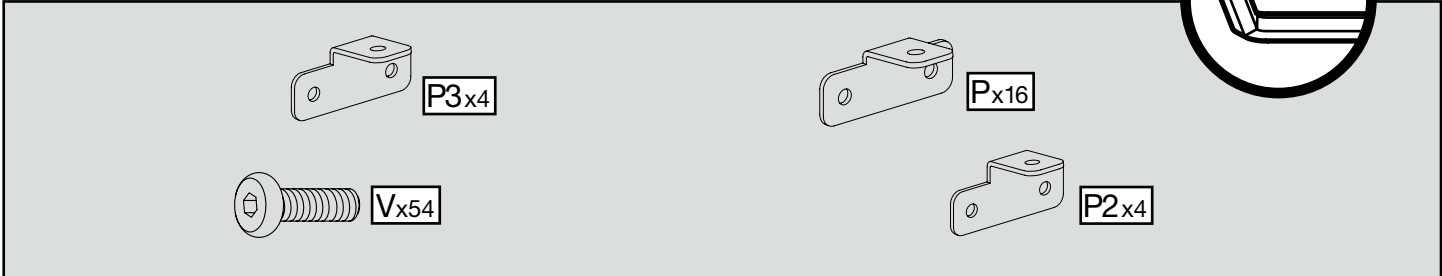
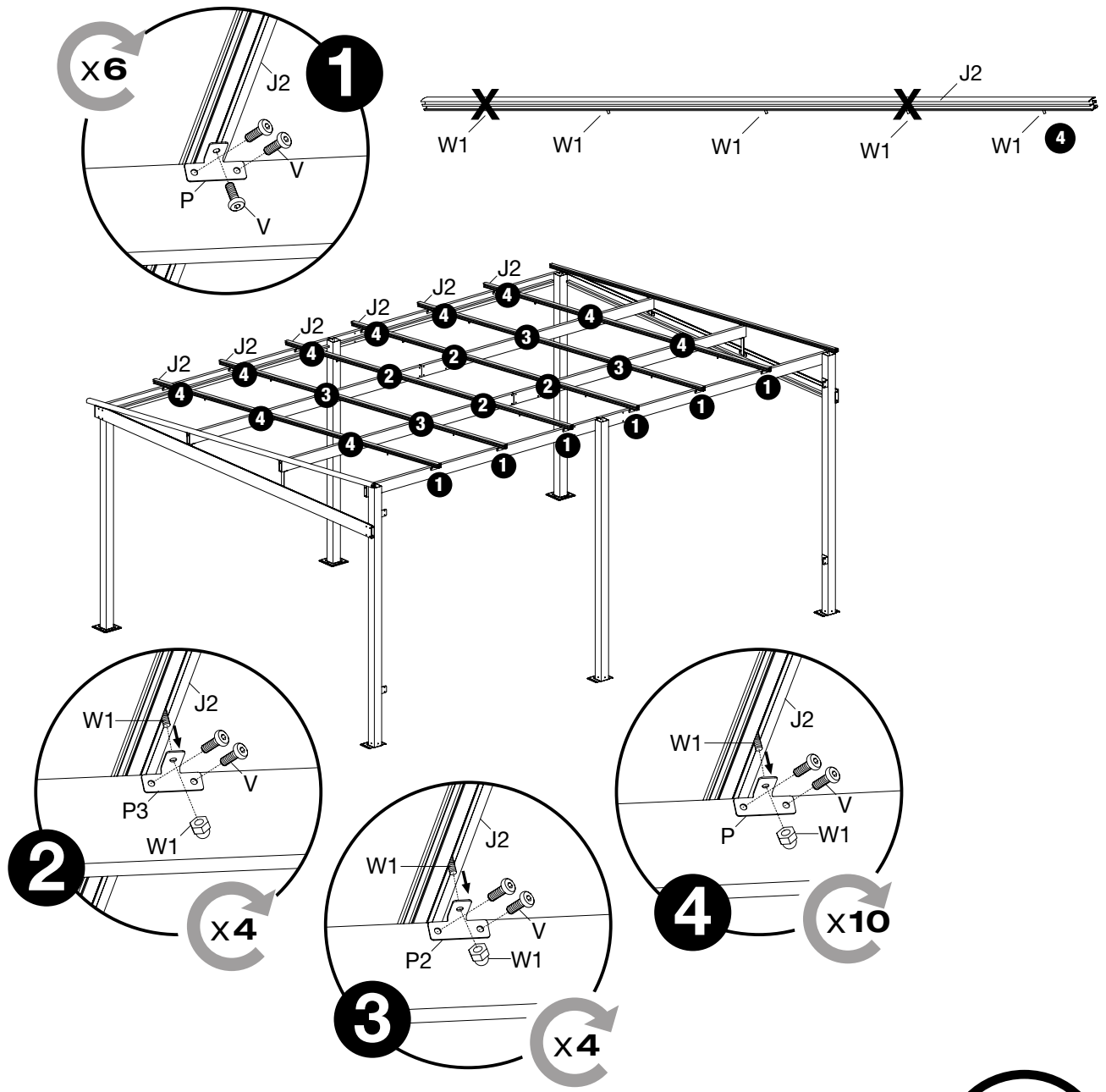

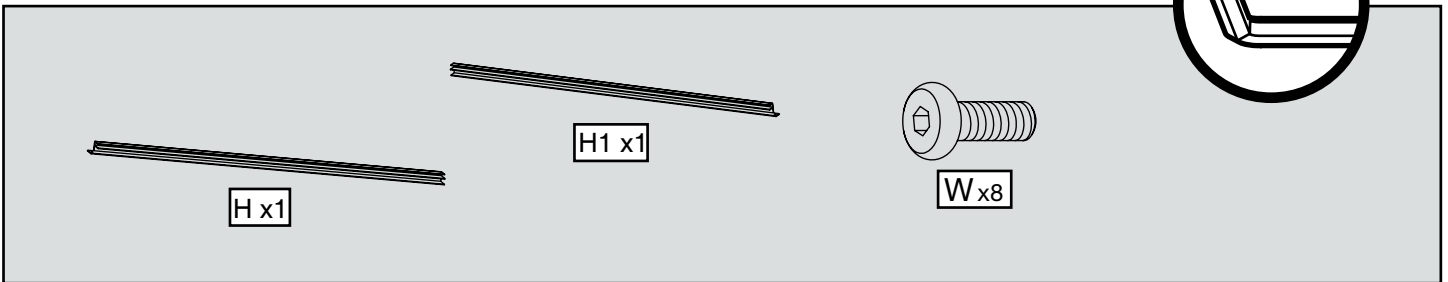
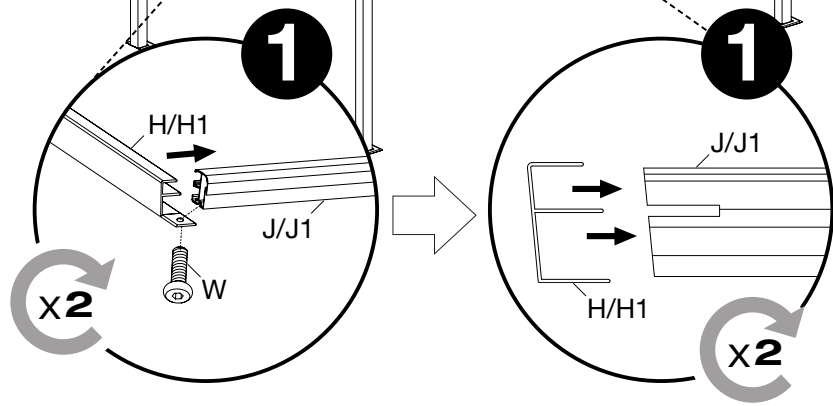
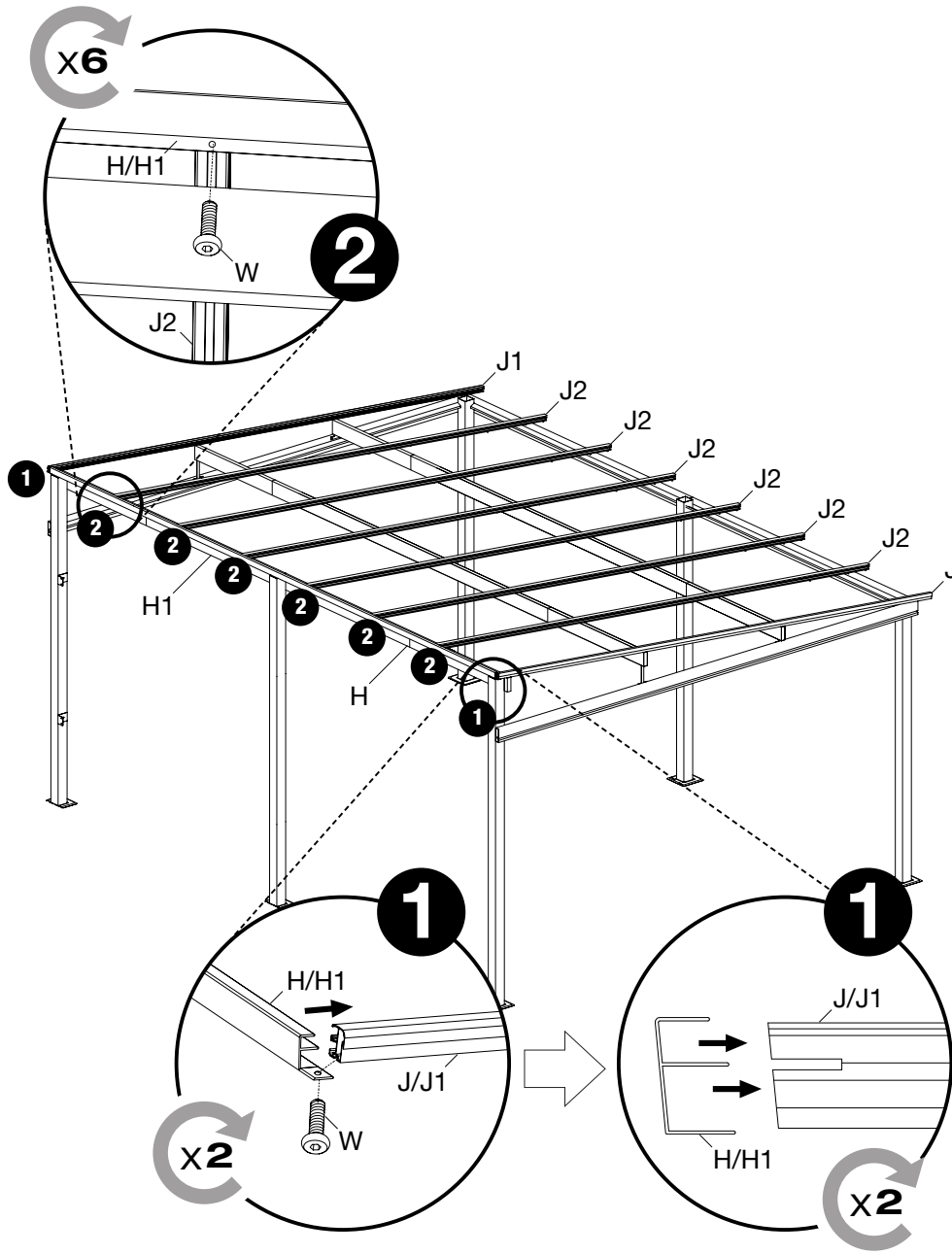

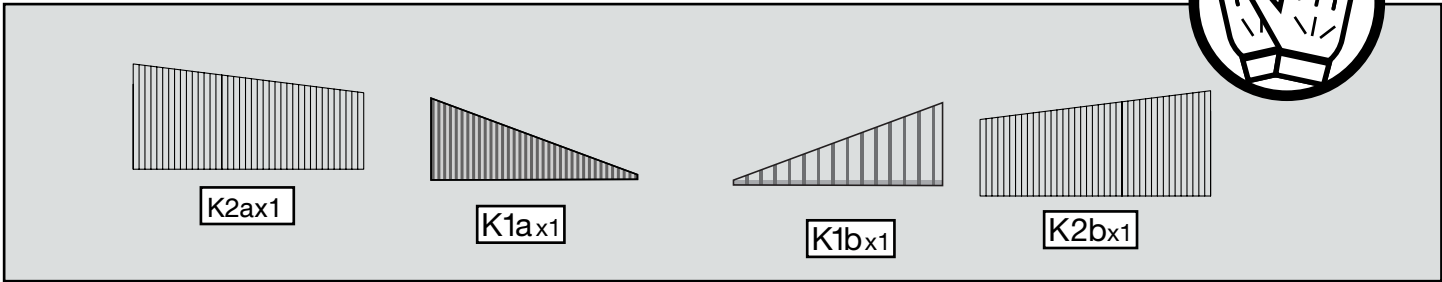
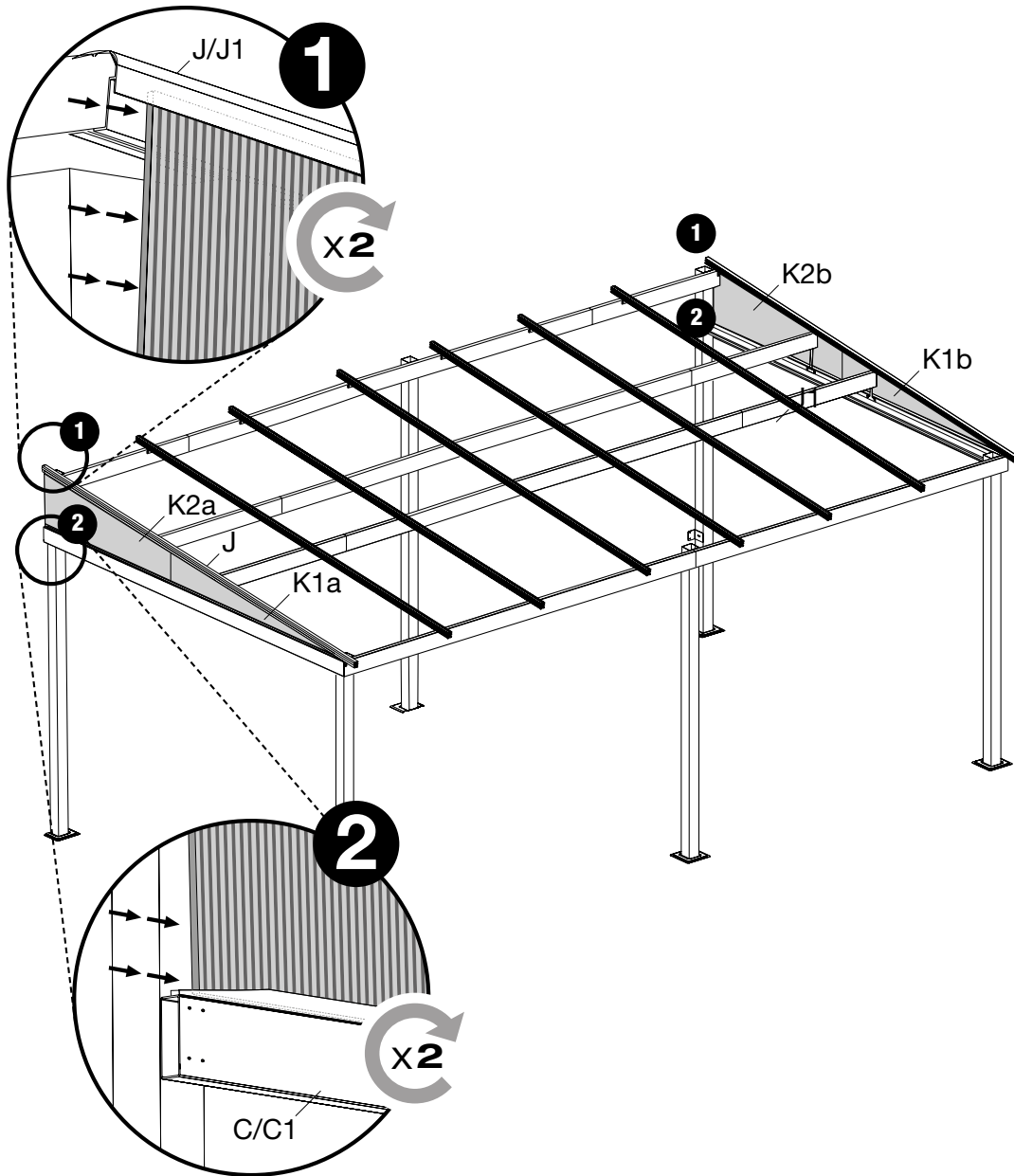

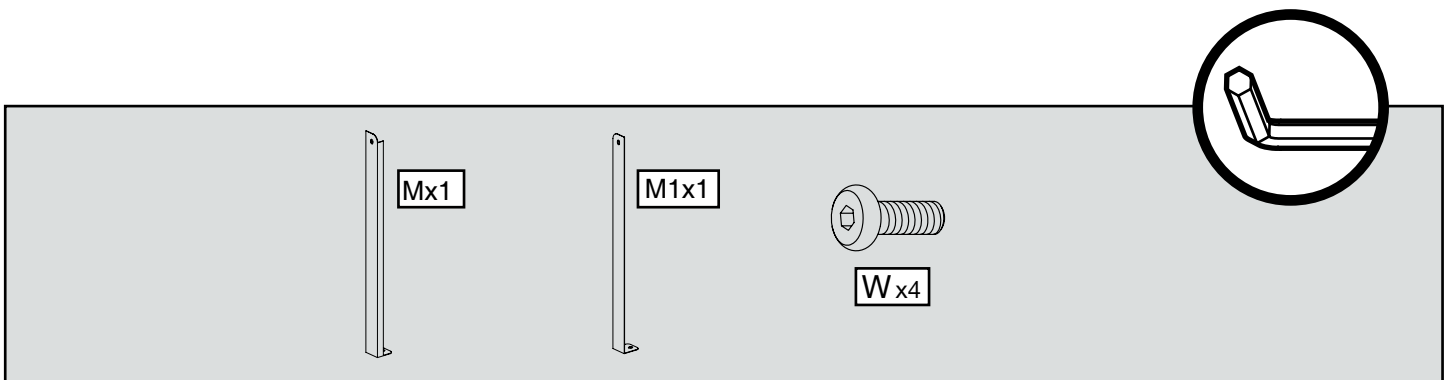
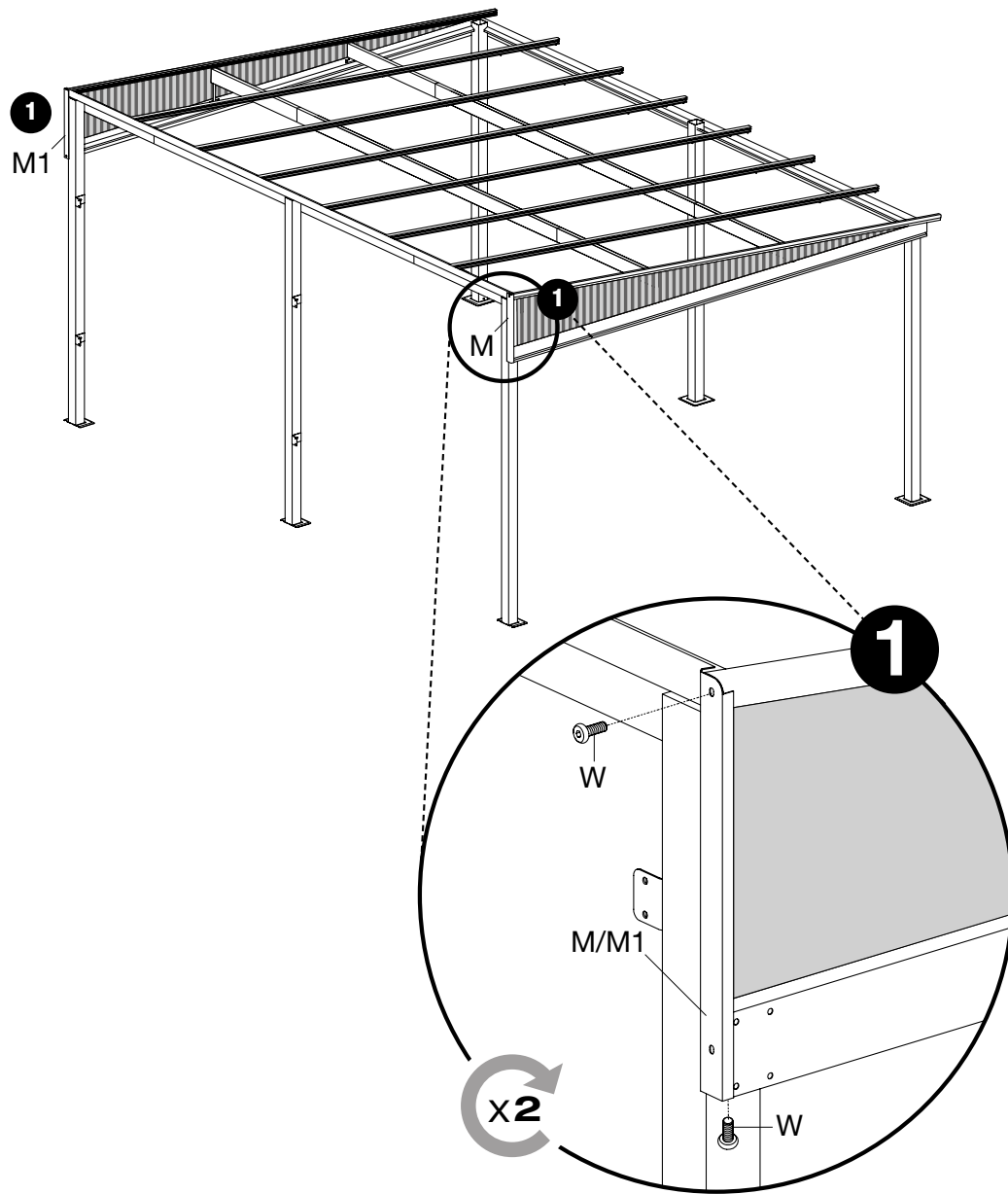

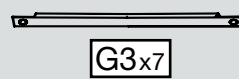
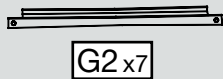
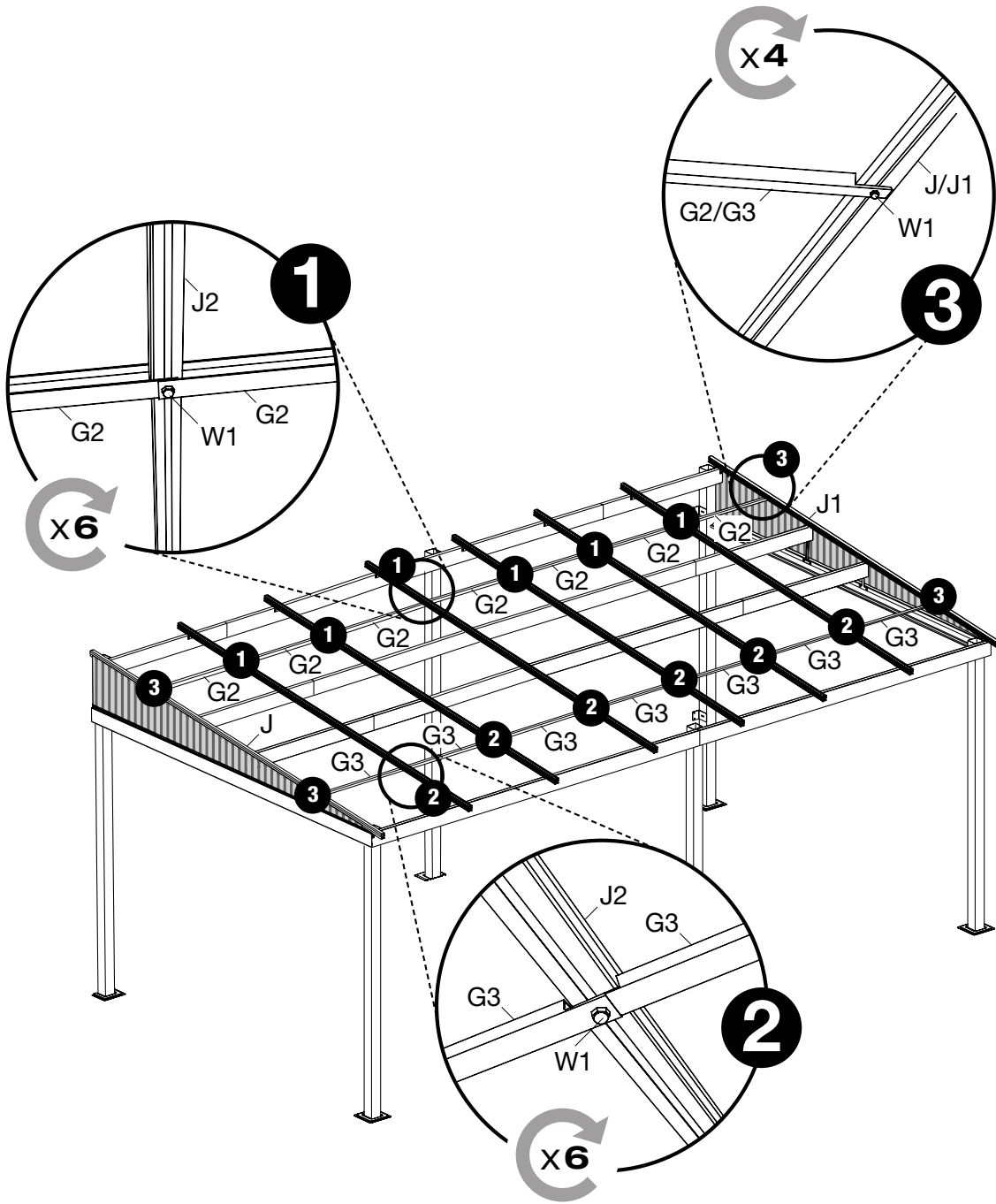

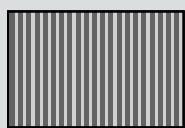
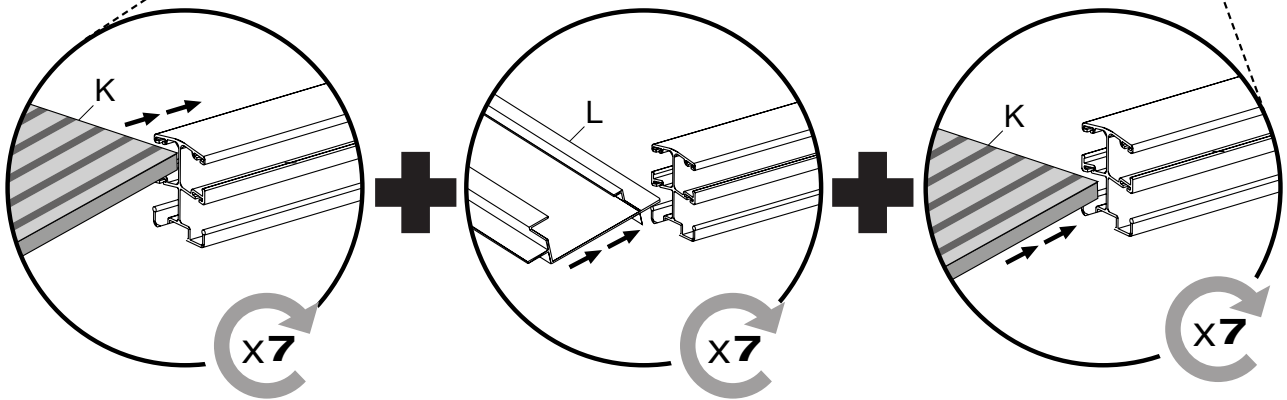
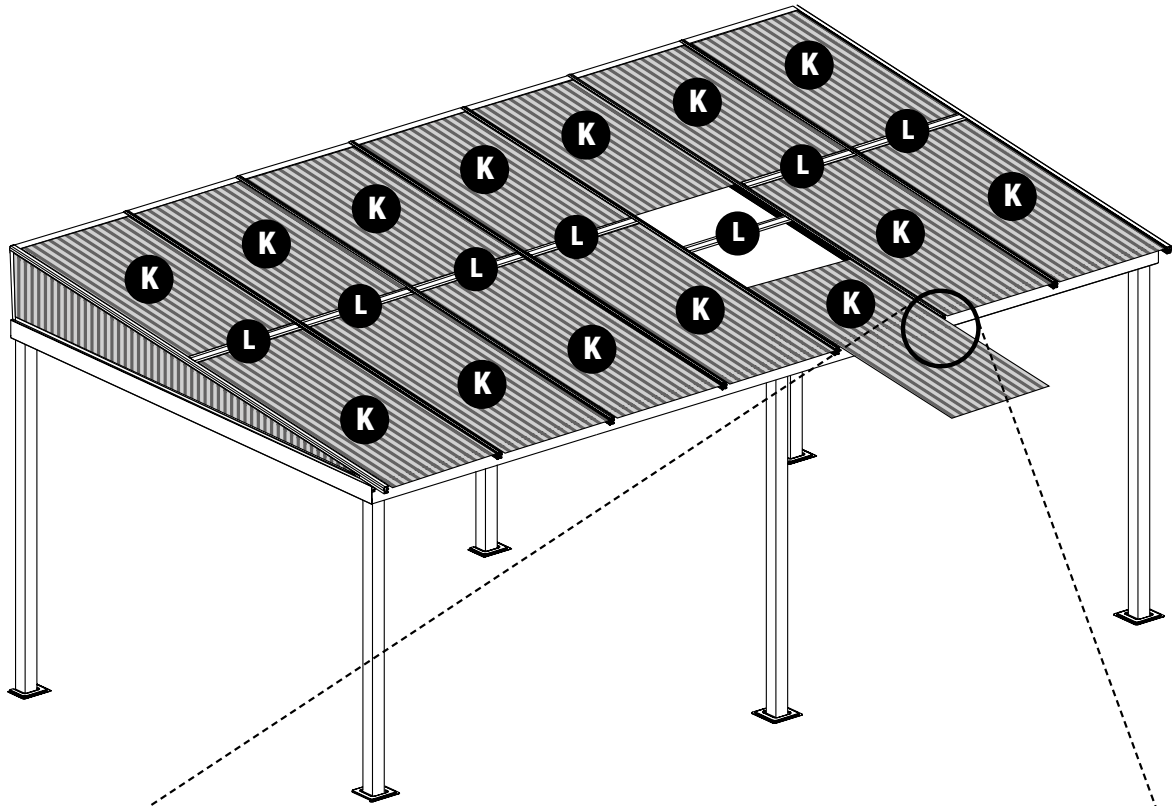

Kx14



Lx7

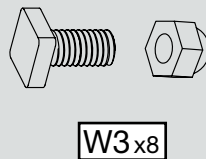
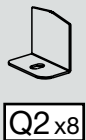
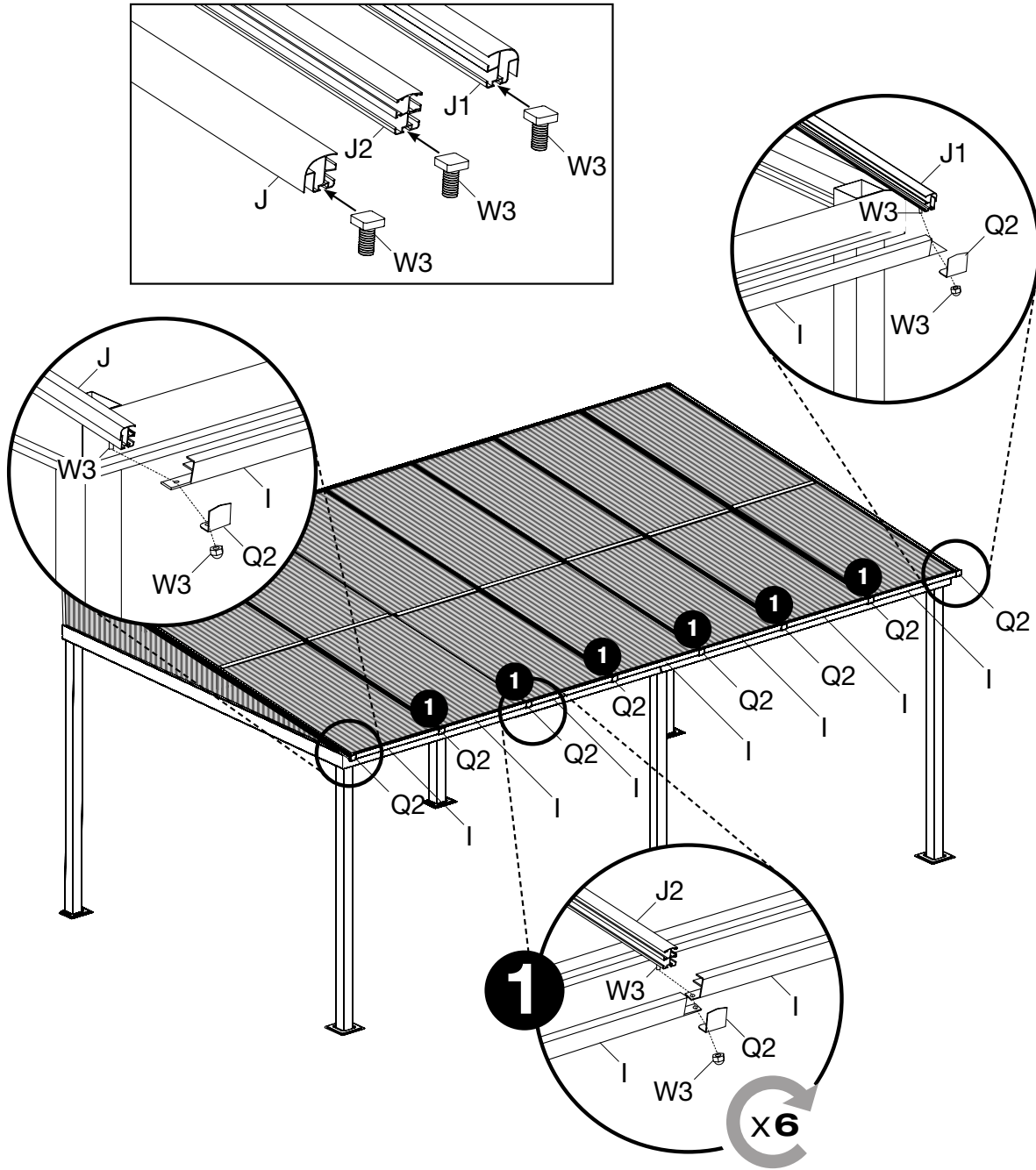

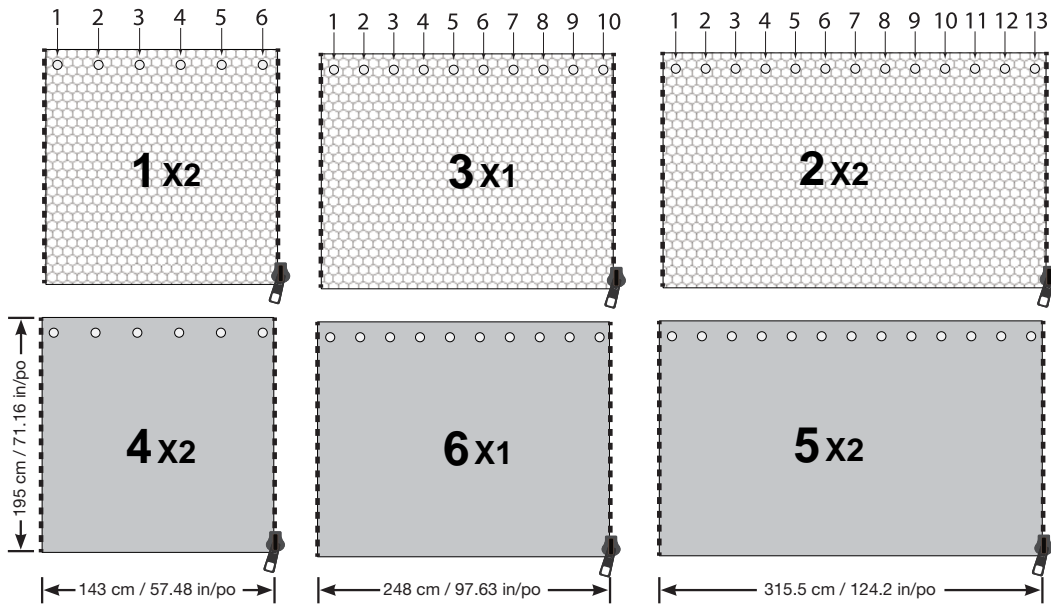
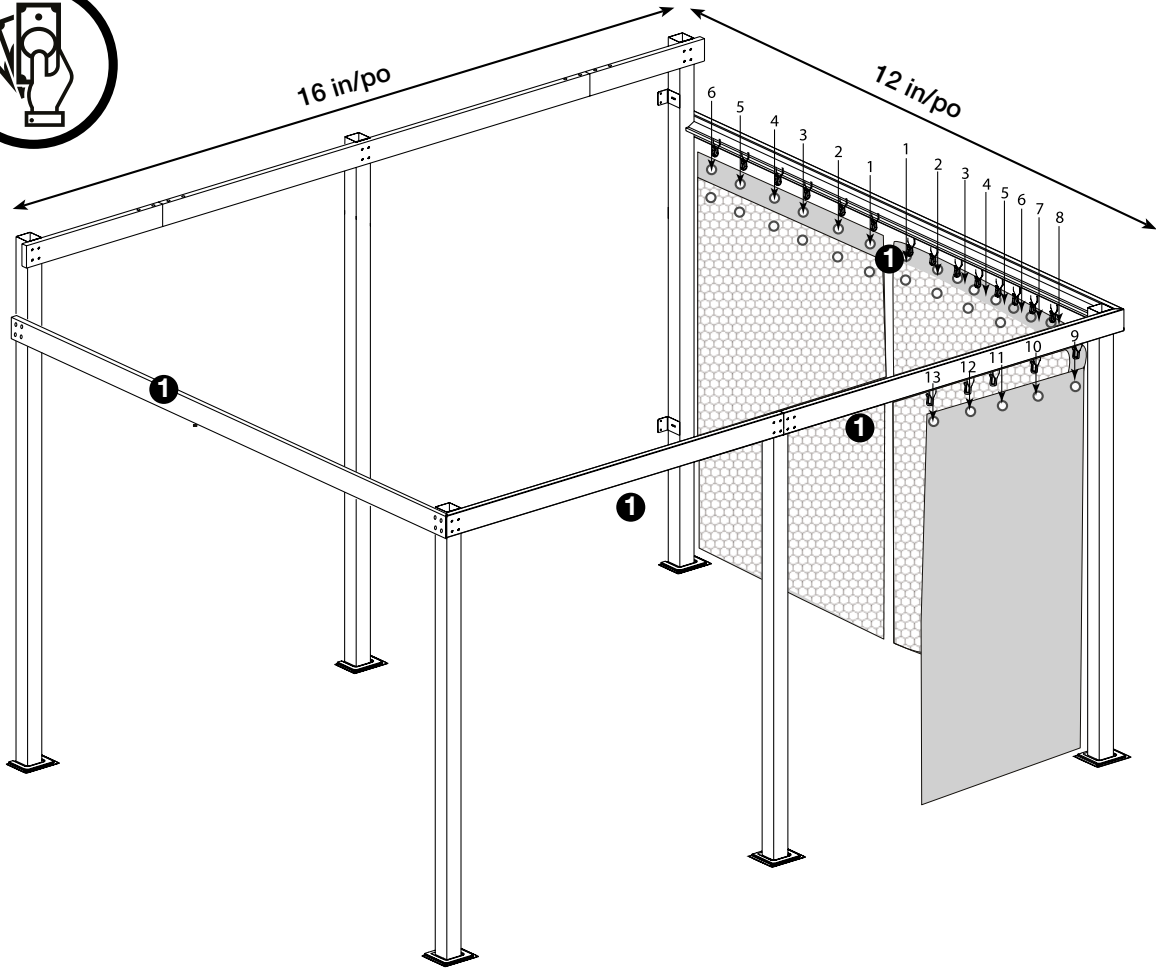
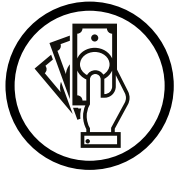

SOJAG ■ I
produits saisonniers • seasonal products