

# SOJAG

produits saisonniers • seasonal products



QUESTIONS? 1 866-901-1649

Sojag code: \_\_\_\_\_

## Assembly Manual / Guide d'assemblage / Manual de ensamblaje / 조립설명서 / Montageanleitung

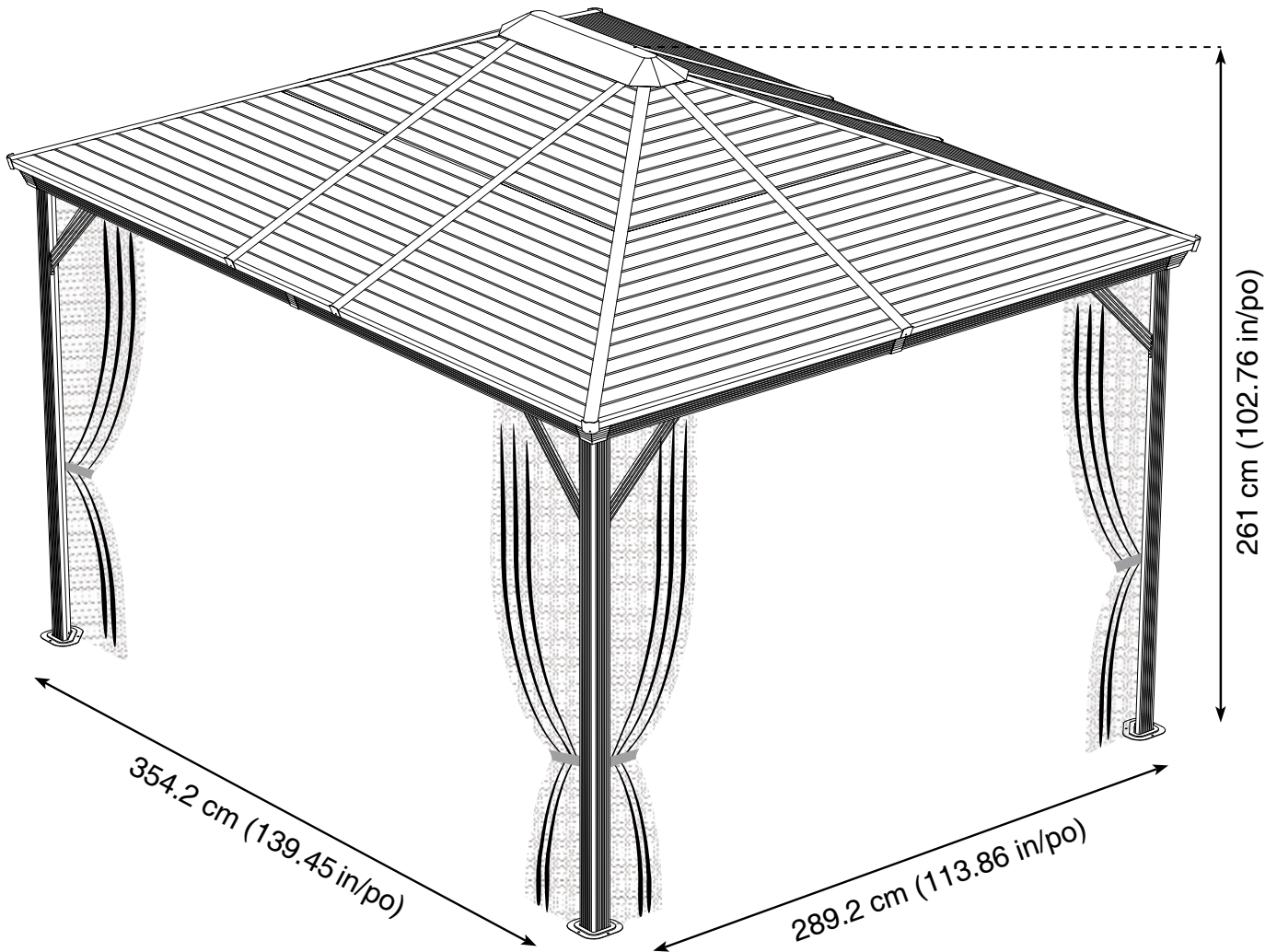

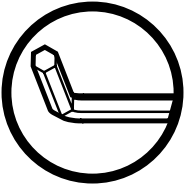

Use the hex keys in the box. / Utilisez les clés hexagonales fournies dans la boîte. /  
Utilice las llaves hexagonales en la caja. / 상자에 육각 키를 사용 하십시오. / Verwenden Sie  
die Sechskantschlüssel in der Box.

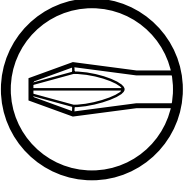

Please use a Phillips screwdriver period / Utilisez un tournevis de type Phillips / Por favor,  
use un destornillador Phillips / 십자 드라이버를 사용 하십시오. / Bitte verwenden Sie einen  
Kreuzschraubenzieher.



you may need to use a drill for this step. / Vous pouvez avoir besoin d'utiliser une  
perceuse pour cette étape. / puede que tenga que utilizar un taladro para este paso. /  
이 단계에선 드릴을 사용해야 할 수도 있습니다. / Für diesen Schritt können Sie einen  
Bohrer verwenden.



Wearing protective gloves is recommended. / Le port de gants de protection est recommandé /  
El uso de guantes de protección se recomienda / 보호 장갑을 착용 하는 것이 좋습니다. /  
Das Tragen von Schutzhandschuhen wird empfohlen.



Two or more people are required at this stage. / Deux personnes ou plus sont nécessaires à cette  
étape. / Dos o más personas se requieren en esta etapa. / 이 단계에서는 두 명 이상이 필요합니다. /  
Für diesen Bauschritt sind 2 oder mehr Personen erforderlich.



Do not screw firmly for now. / Ne pas visser fermement pour l'instant. / No atornille con  
firmeza por ahora. / 아직 나사를 단단히 조이지 마십시오. / Bitte die Schrauben zum  
jetzigen Zeitpunkt noch nicht fest anziehen.



Sold separately / Vendus séparément / vendido en las opciones /  
옵션 판매 / Optional erhältlich

**T** X 8 (+2)

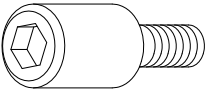

**U** X 16 (+2)

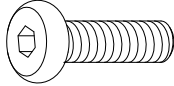

**U1** X 40 (+8)

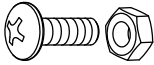

**U2** X 2 (+1)

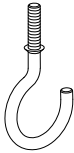

**U3** X 1 (+1)

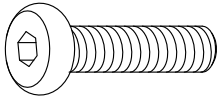

**V** X 84 (+10)

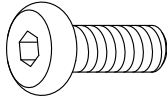

**V1** X 16 (+2)

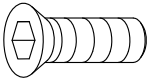

**V2** X 20 (+2)

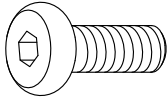

**W** X 34 (+4)

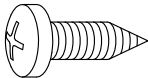

**W1** X 16 (+2)

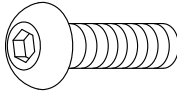



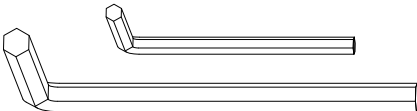



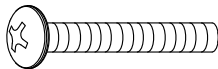

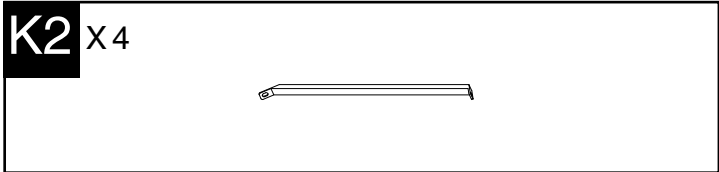
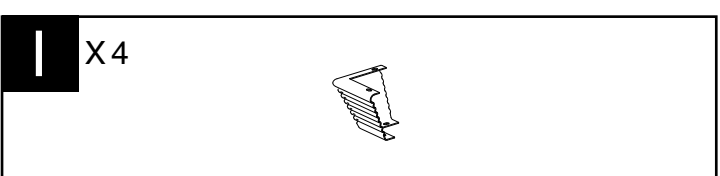
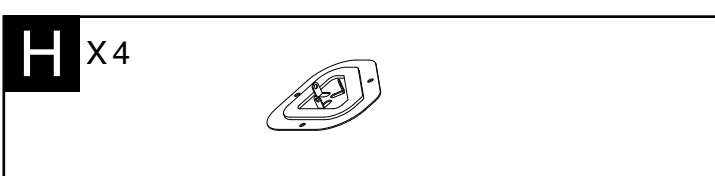
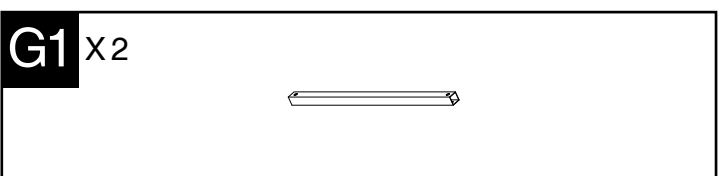
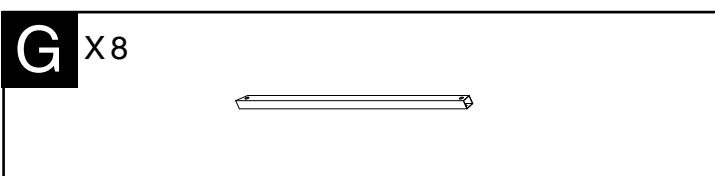
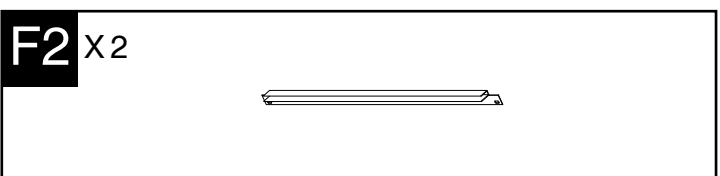
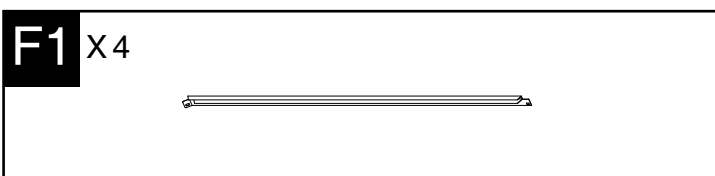
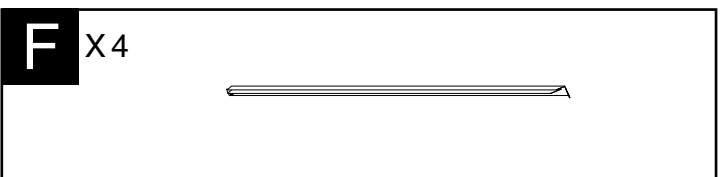
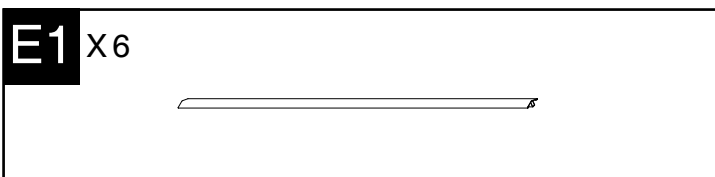
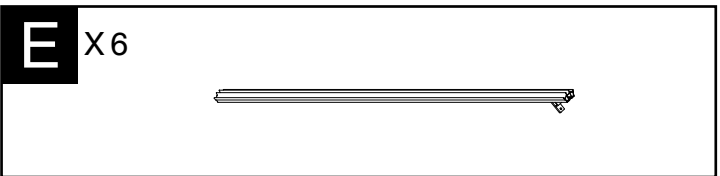
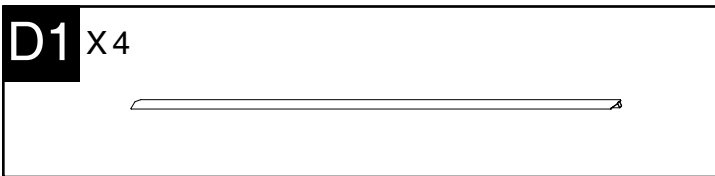
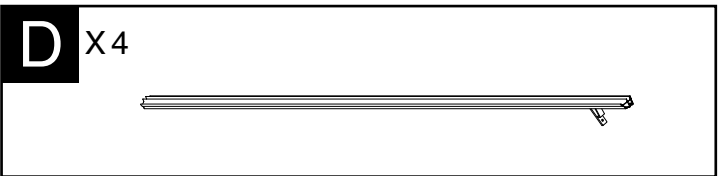
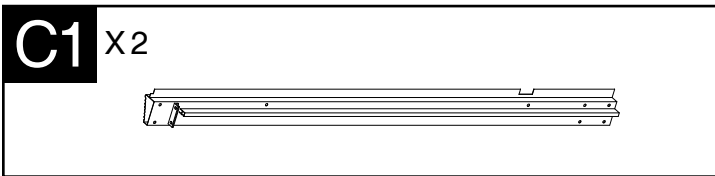
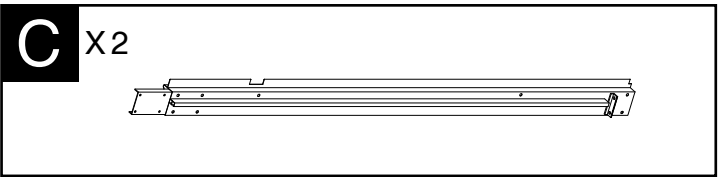
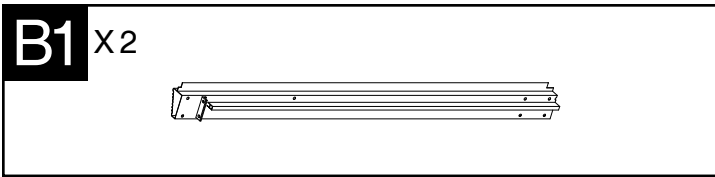
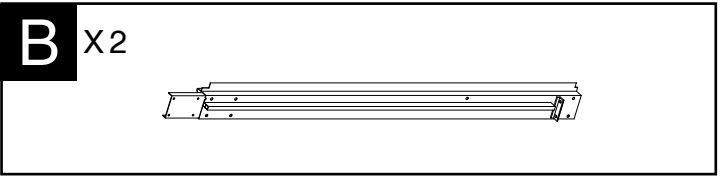

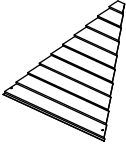
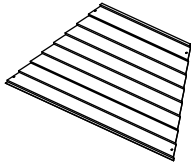
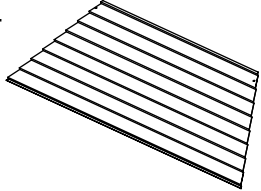
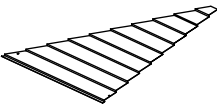
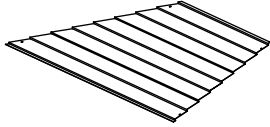
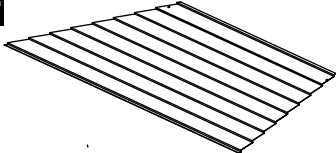
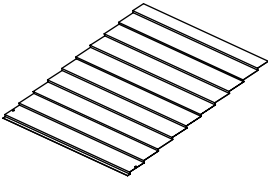
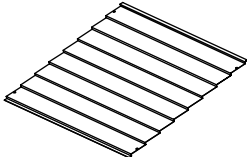
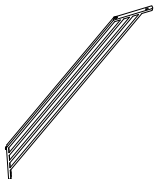

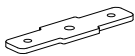
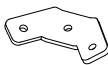
**Y** X 1

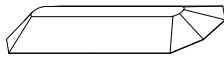
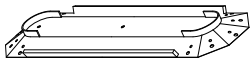

**Y1** X 44 (+4)

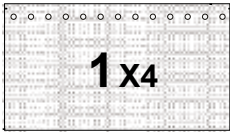

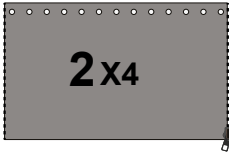

<b>N</b> X4 	<b>N1</b> X4 	<b>N2</b> X4 
<b>O</b> X4 	<b>O1</b> X4 	<b>O2</b> X4 
<b>P</b> X2 	<b>P1</b> X4 	
<b>K</b> X8 	<b>L</b> X4 	
<b>M3</b> X6 	<b>M4</b> X4 	
<b>Q</b> X4 	<b>R</b> X6 	<b>S</b> X1 
<b>S1</b> X1 	<b>X</b> X52 optional   	
<b>Net</b>  <b>1</b> X4  optional	<b>Curtain</b>  <b>2</b> X4  optional	

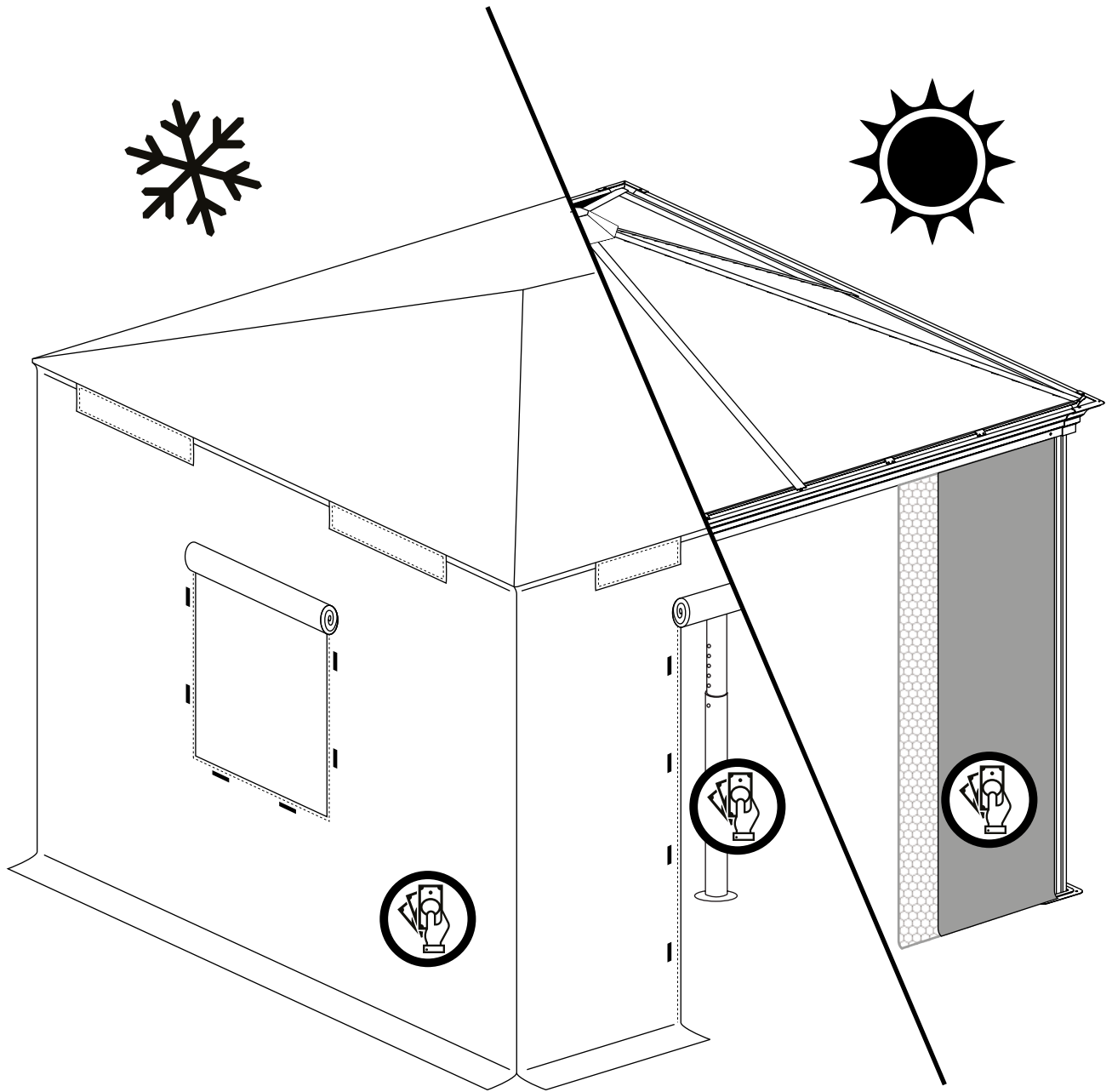
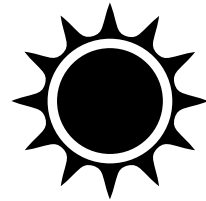

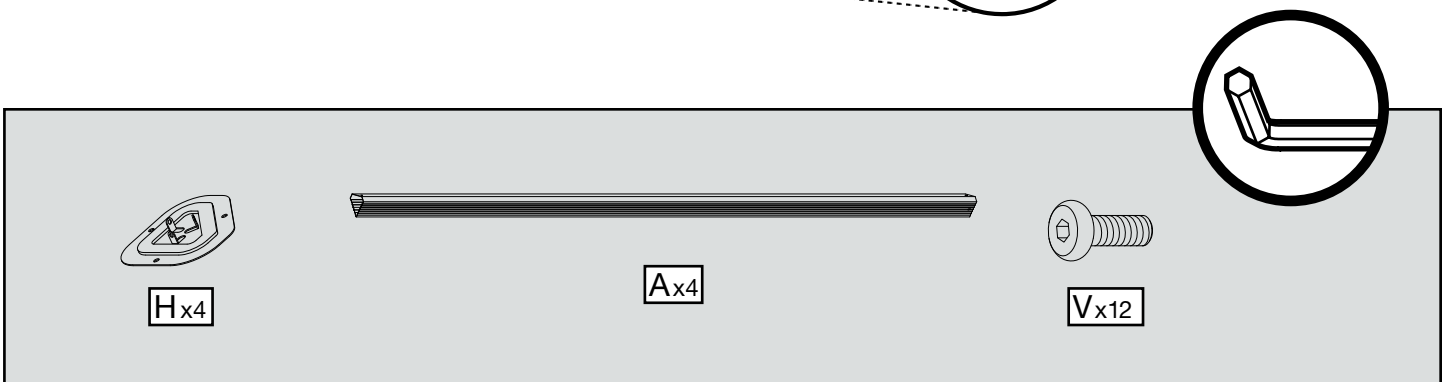
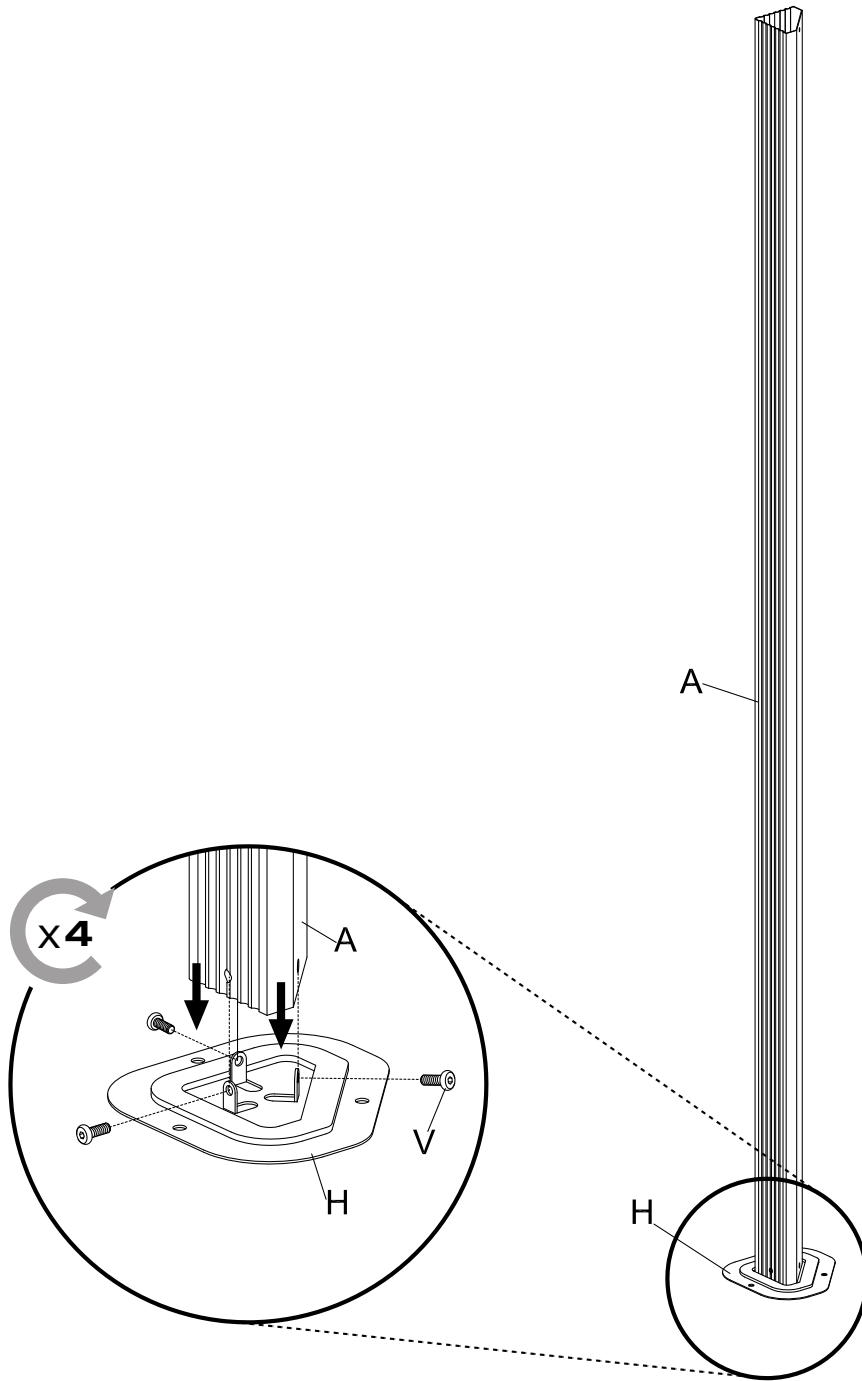

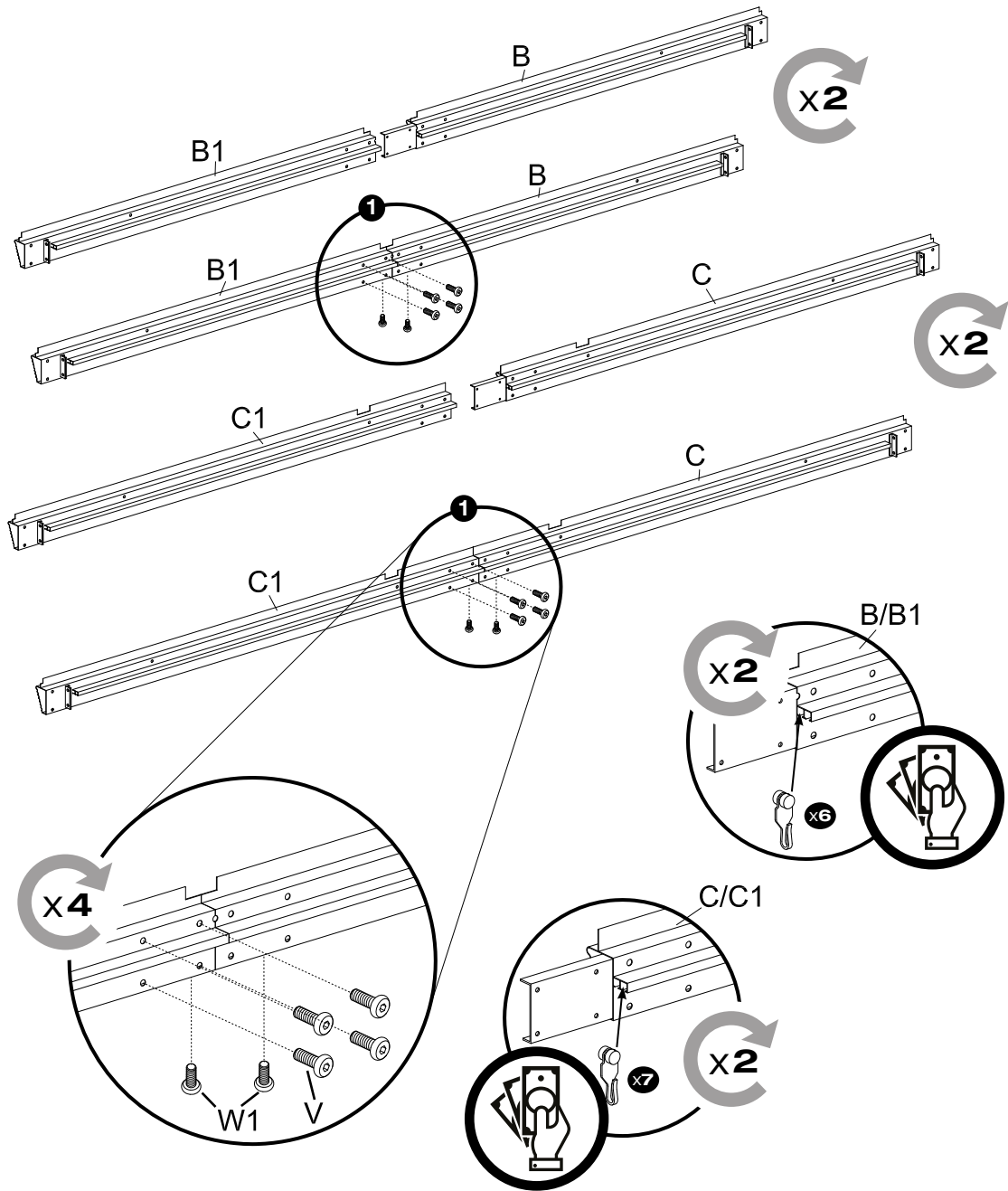

 Bx2	 Cx2		
 B1x2	 C1x2		
 Vx16		 W1x8	 Xx52
			 Xx52

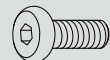
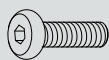
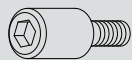
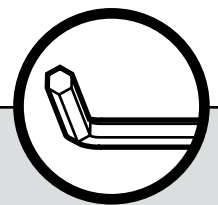
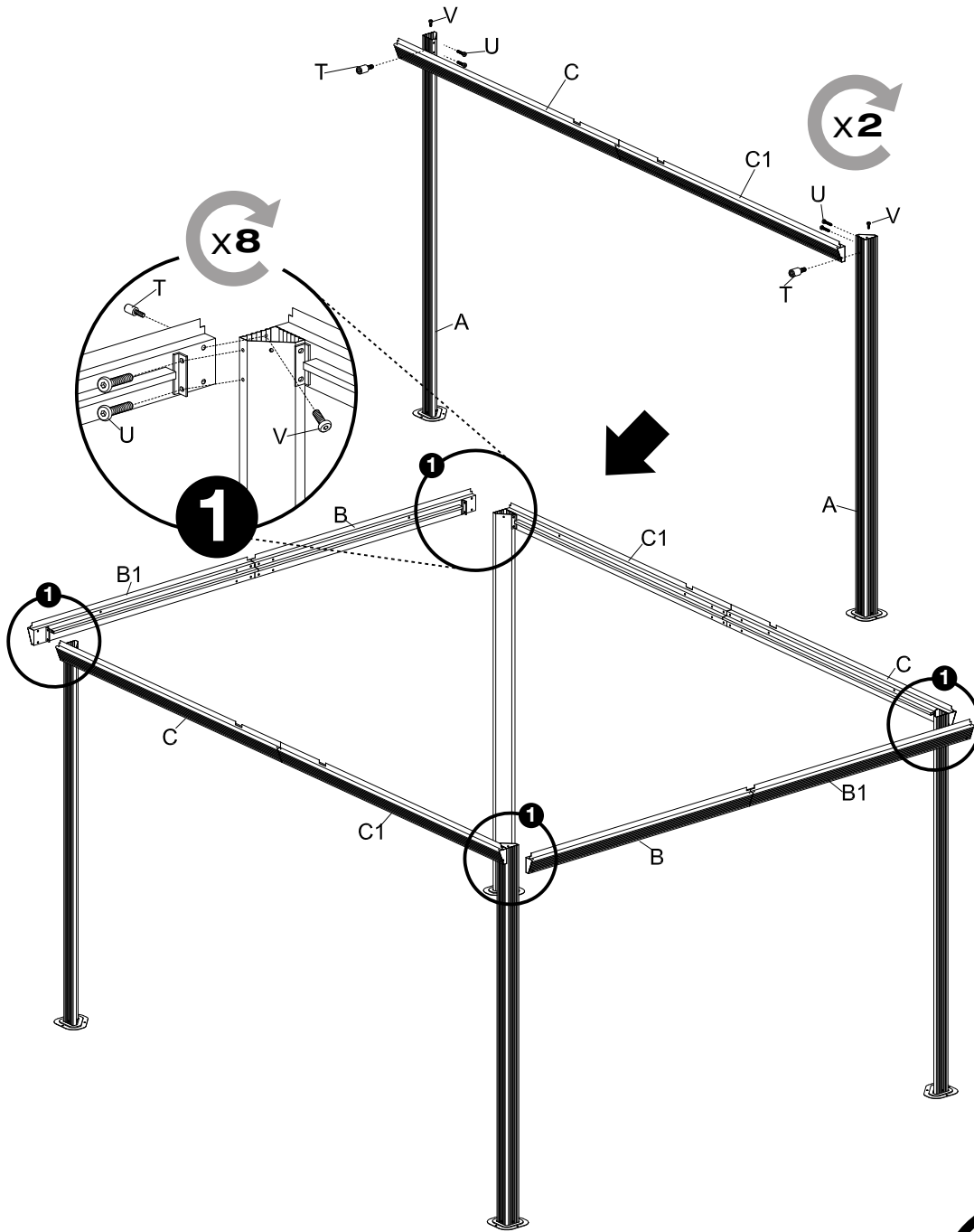

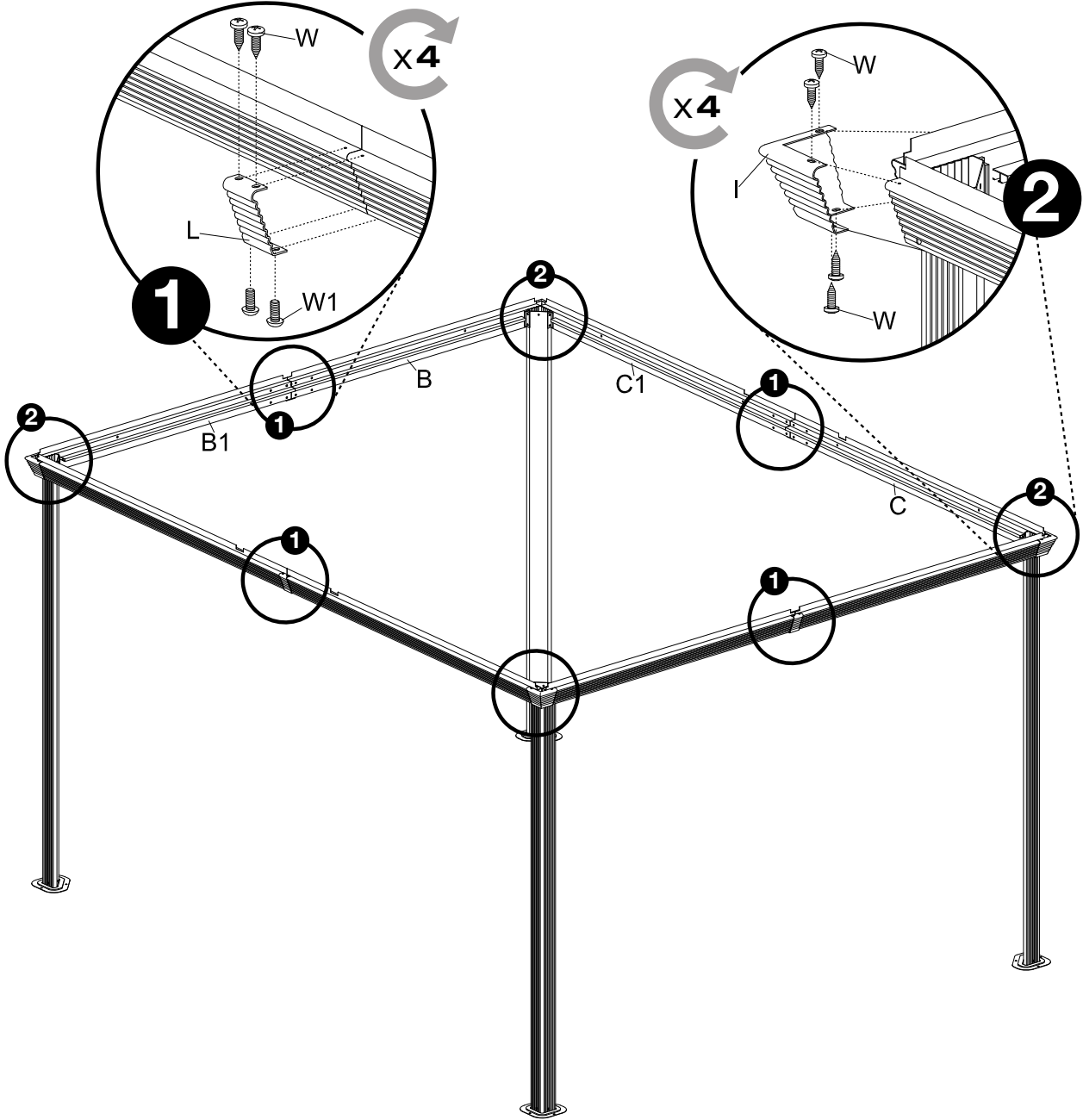

Wx24

W1x8

Ix4

Lx4

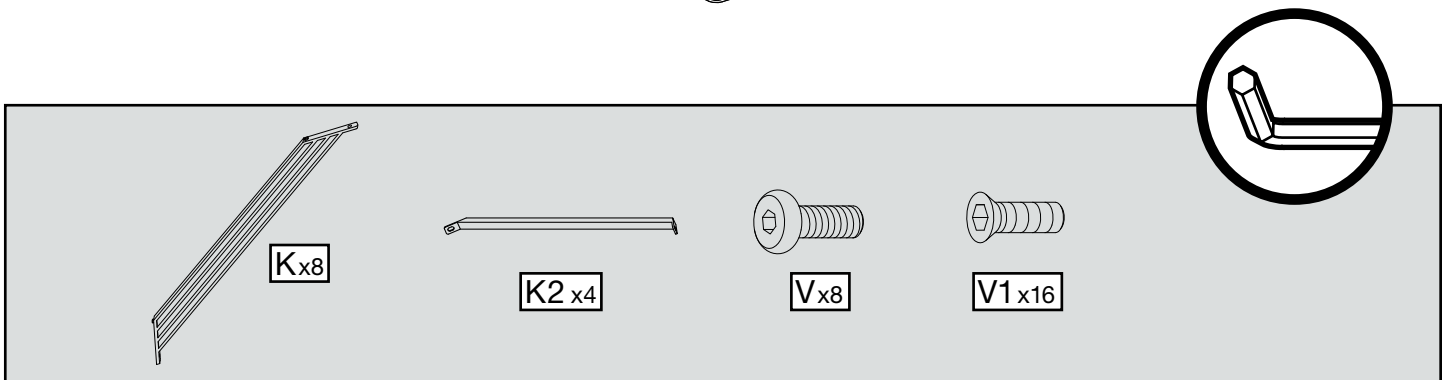
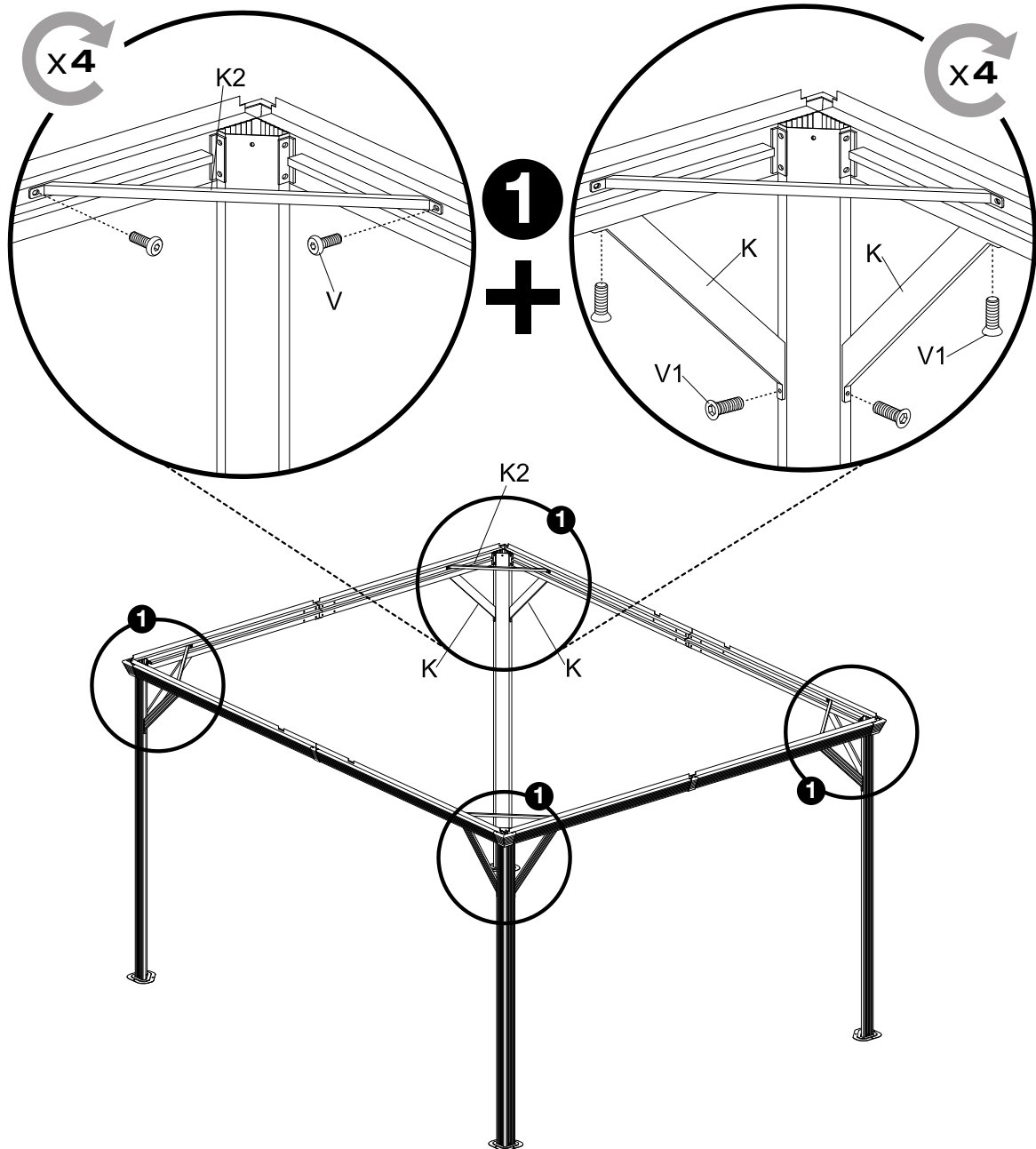

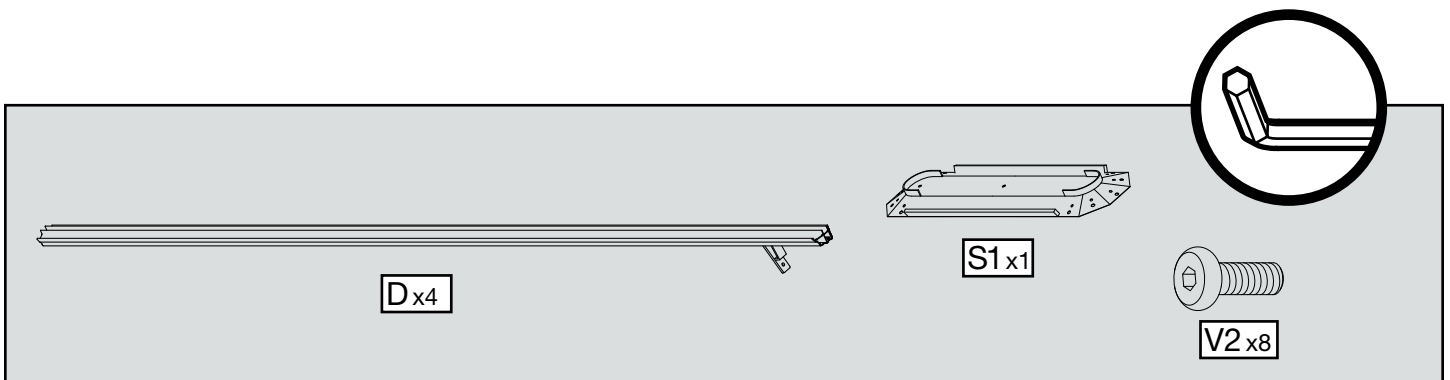
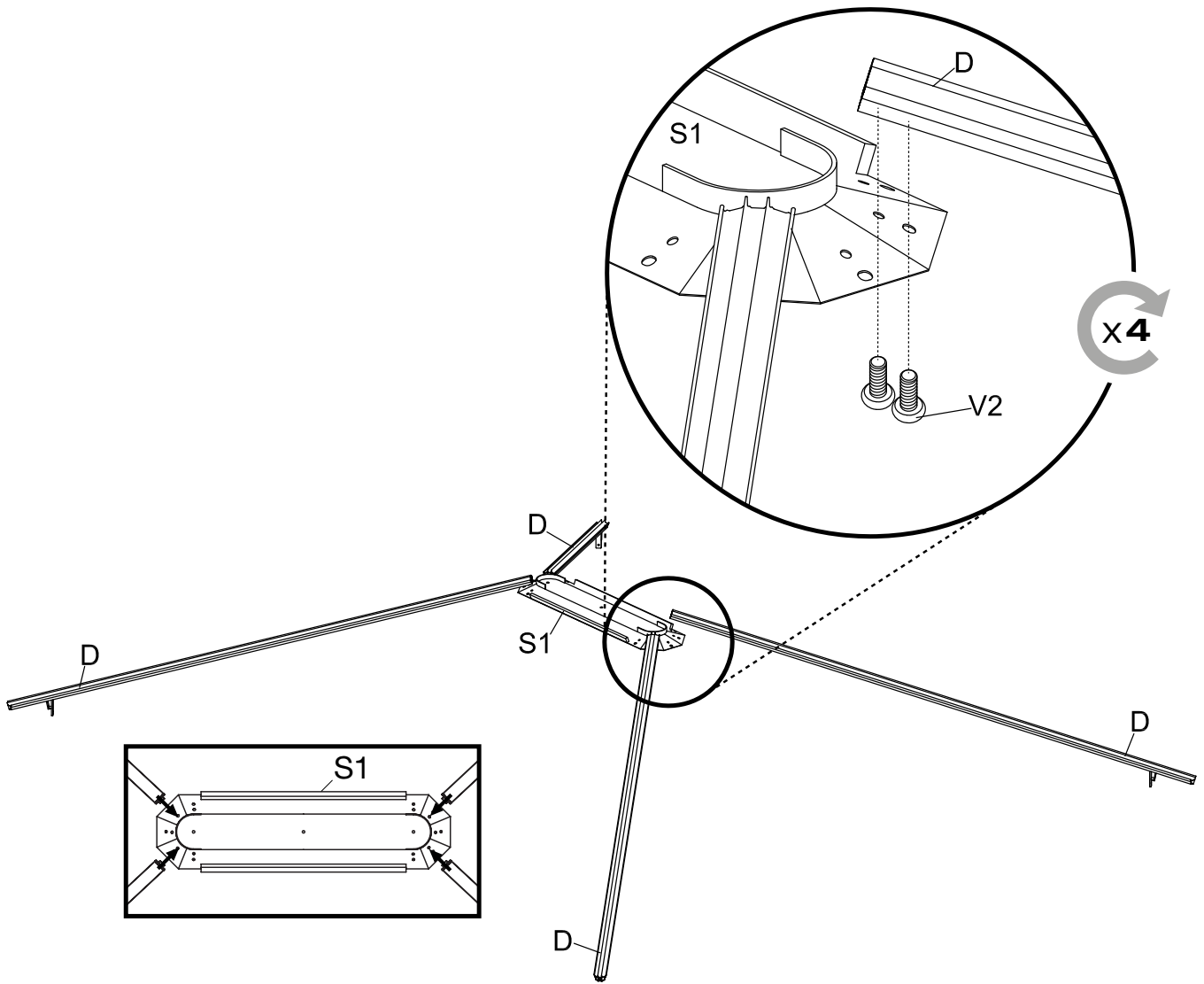

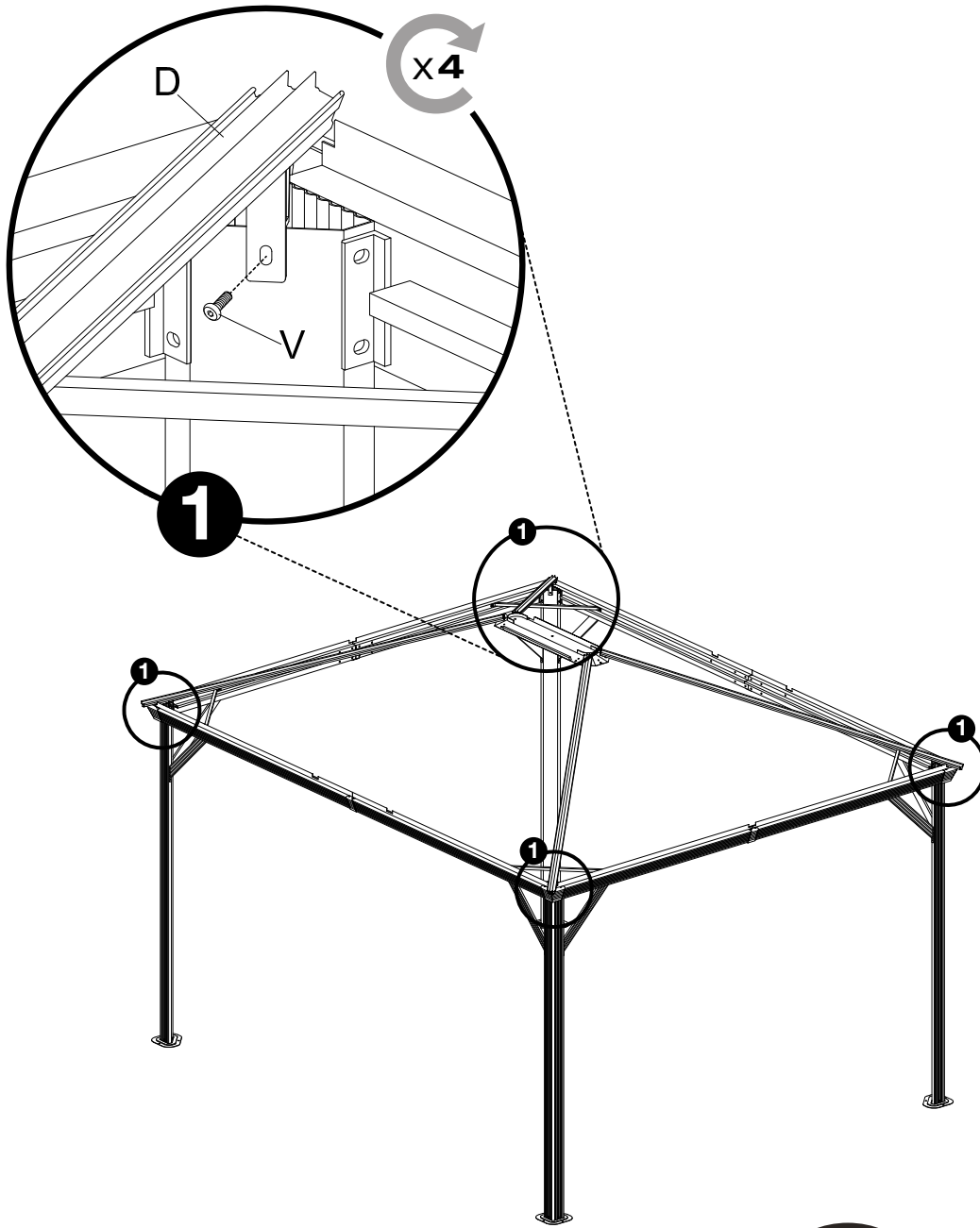

This section contains the material list and safety icons. On the left, a screw is shown with the label 'Vx4' below it. On the right, there are two circular icons: one with two stylized human figures and the text '2+' below them, and another with a pencil and square, representing a marking tool.

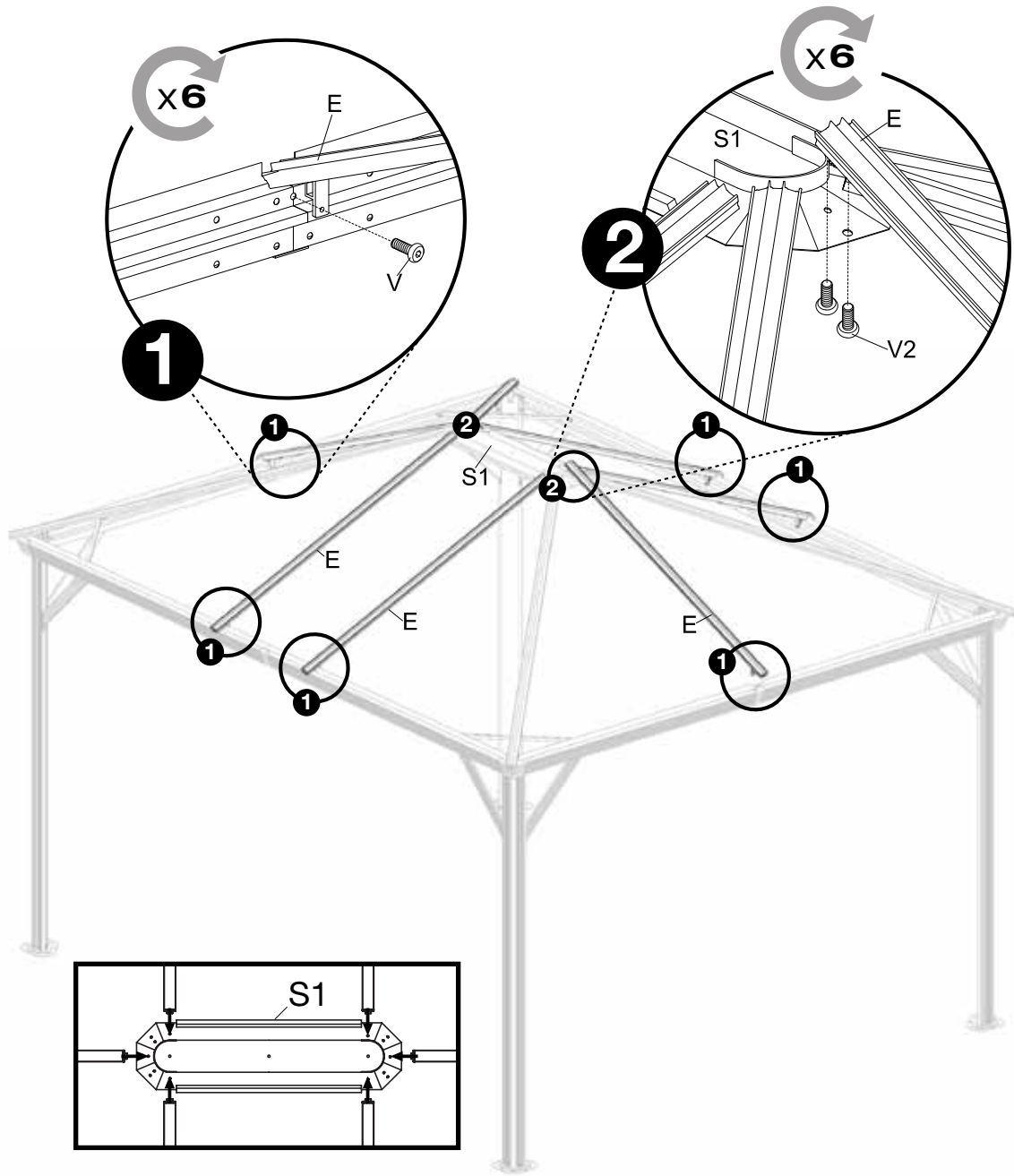

**E x6**

**V x6**

**V2 x12**

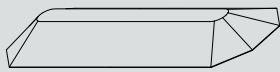
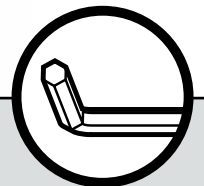
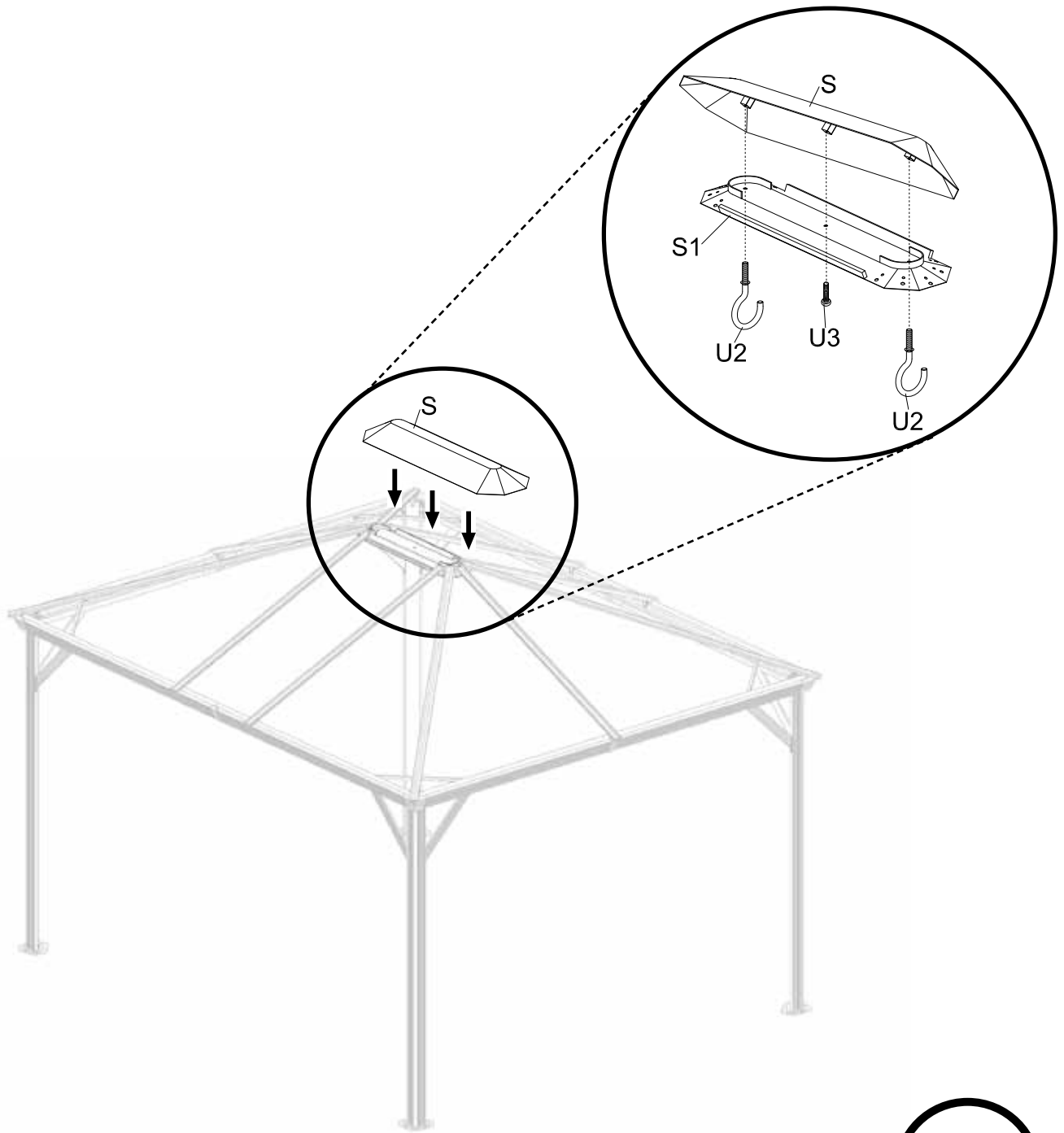

Sx1



U2x2

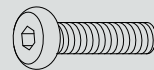

U3x1

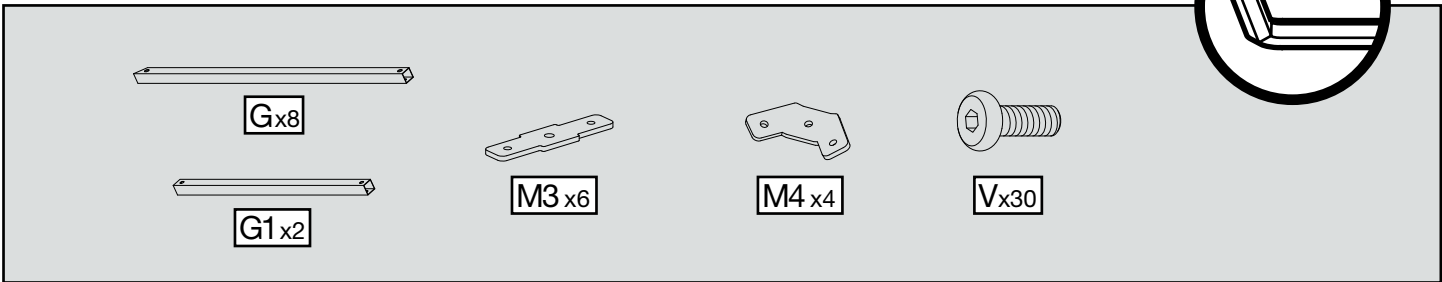
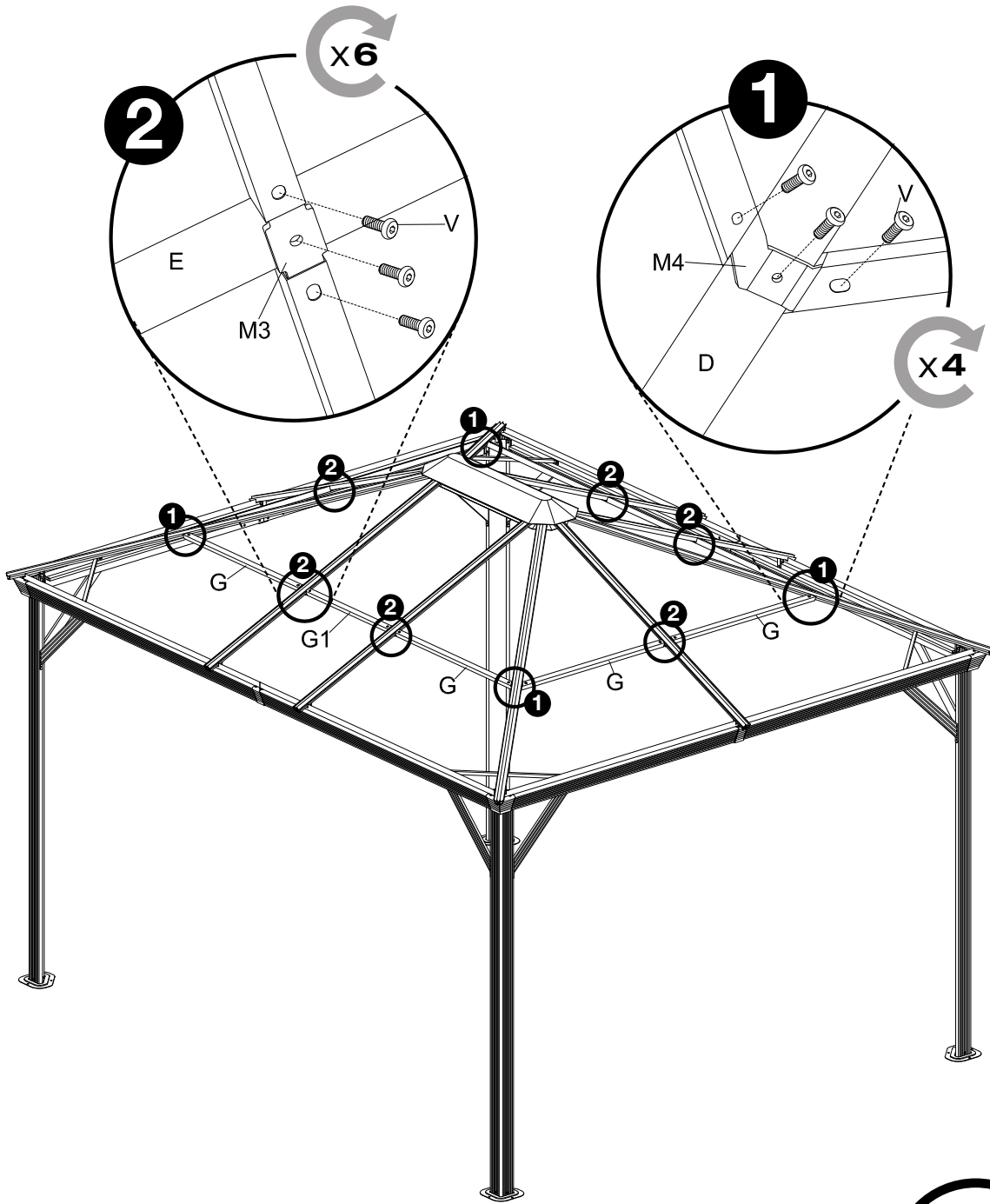

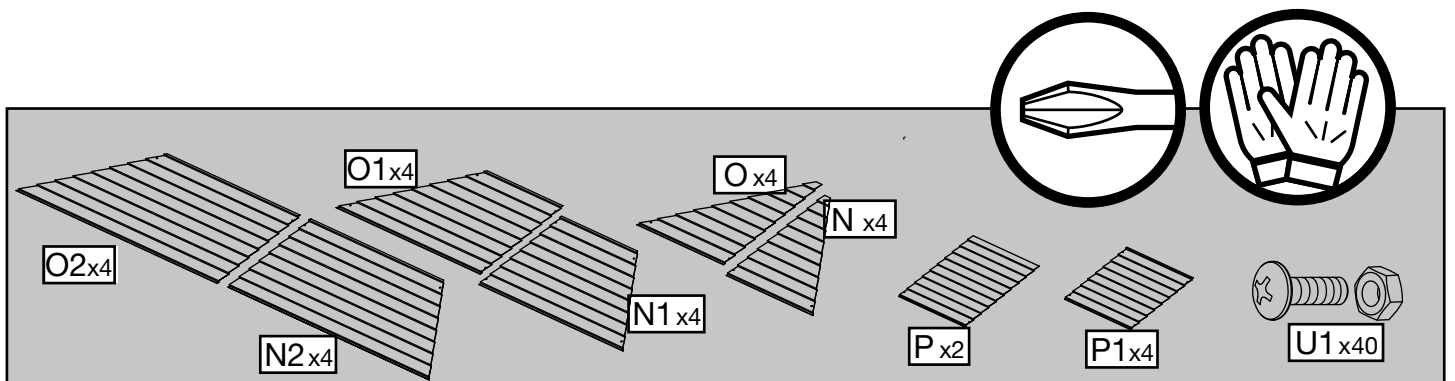
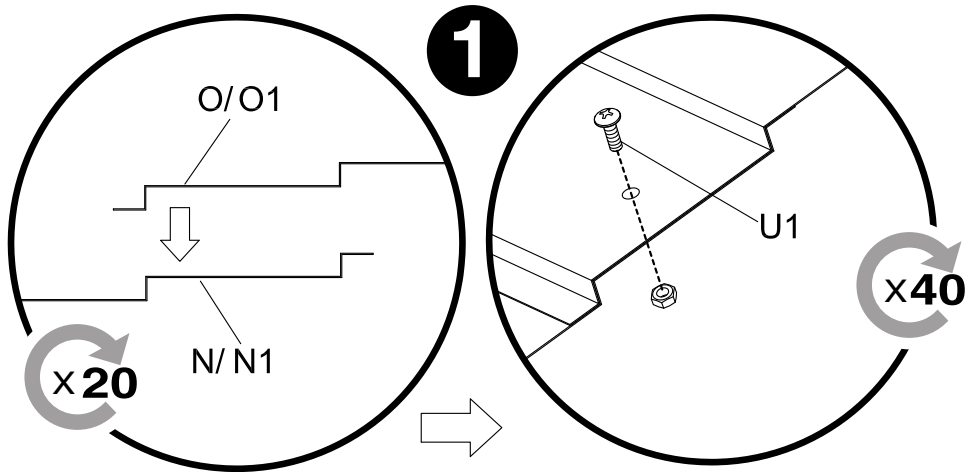
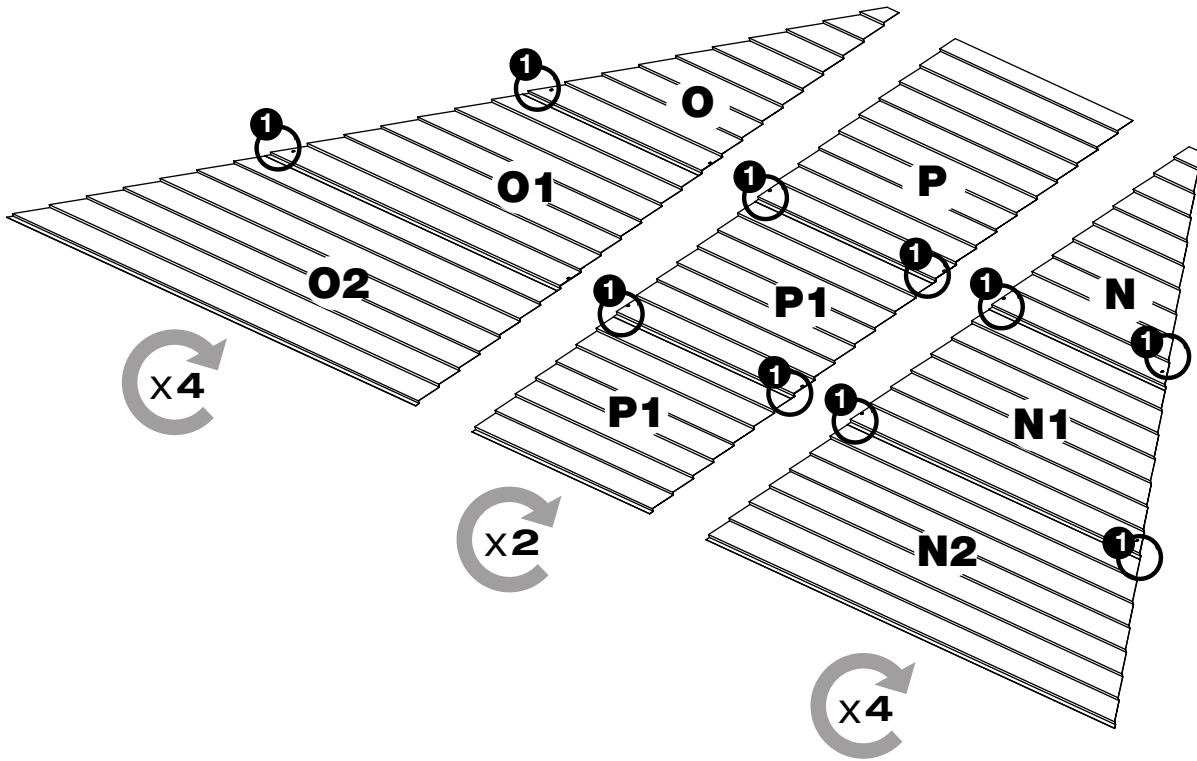

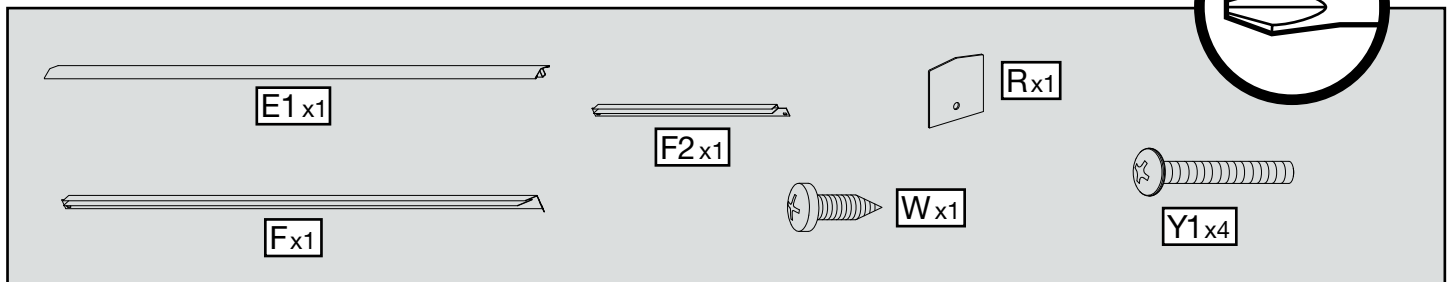
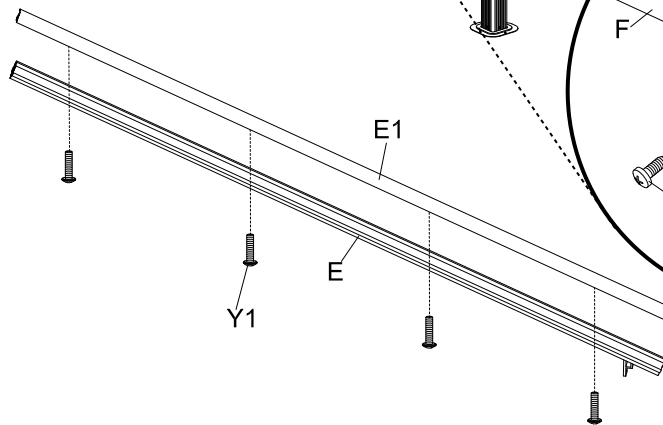
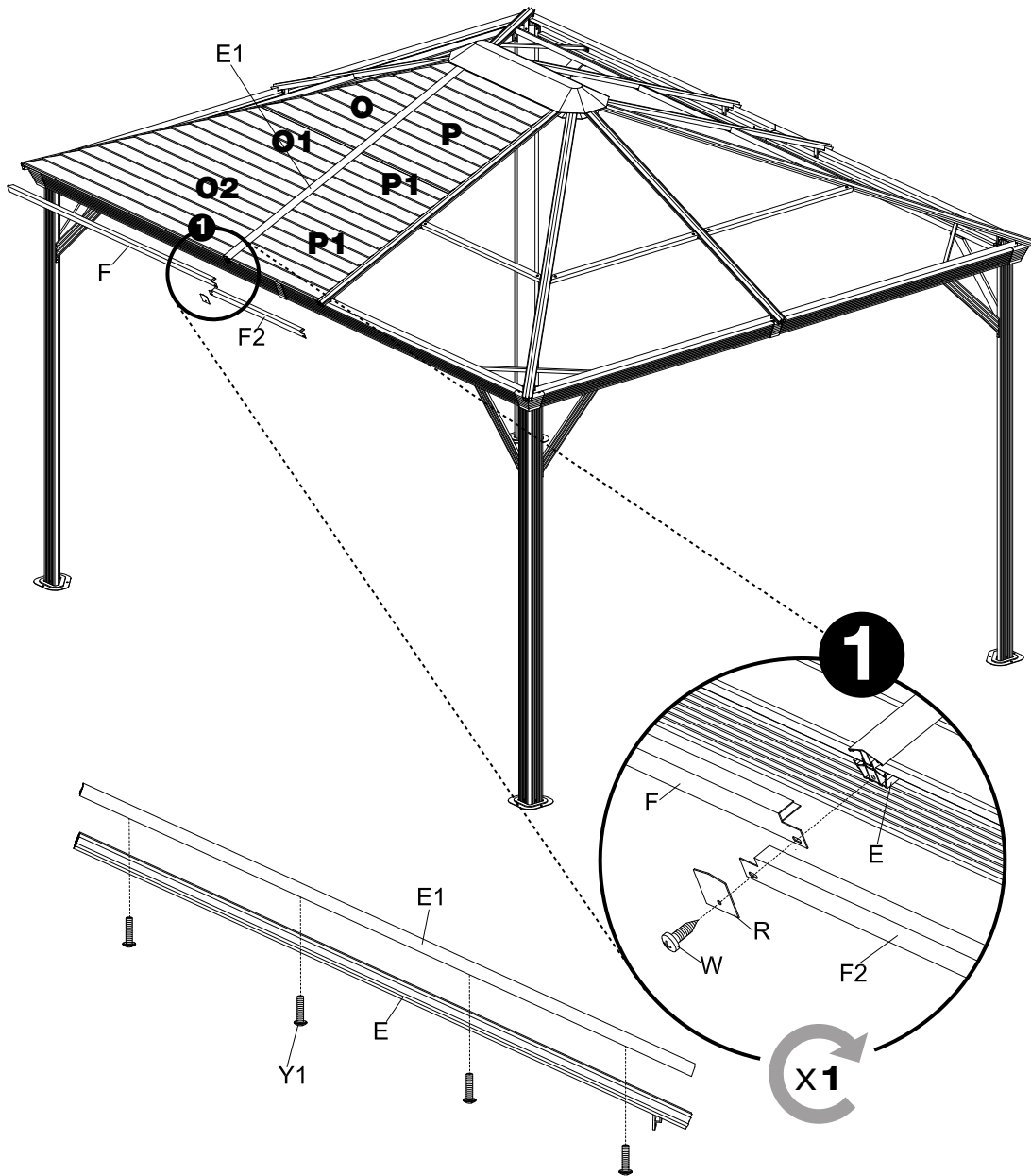

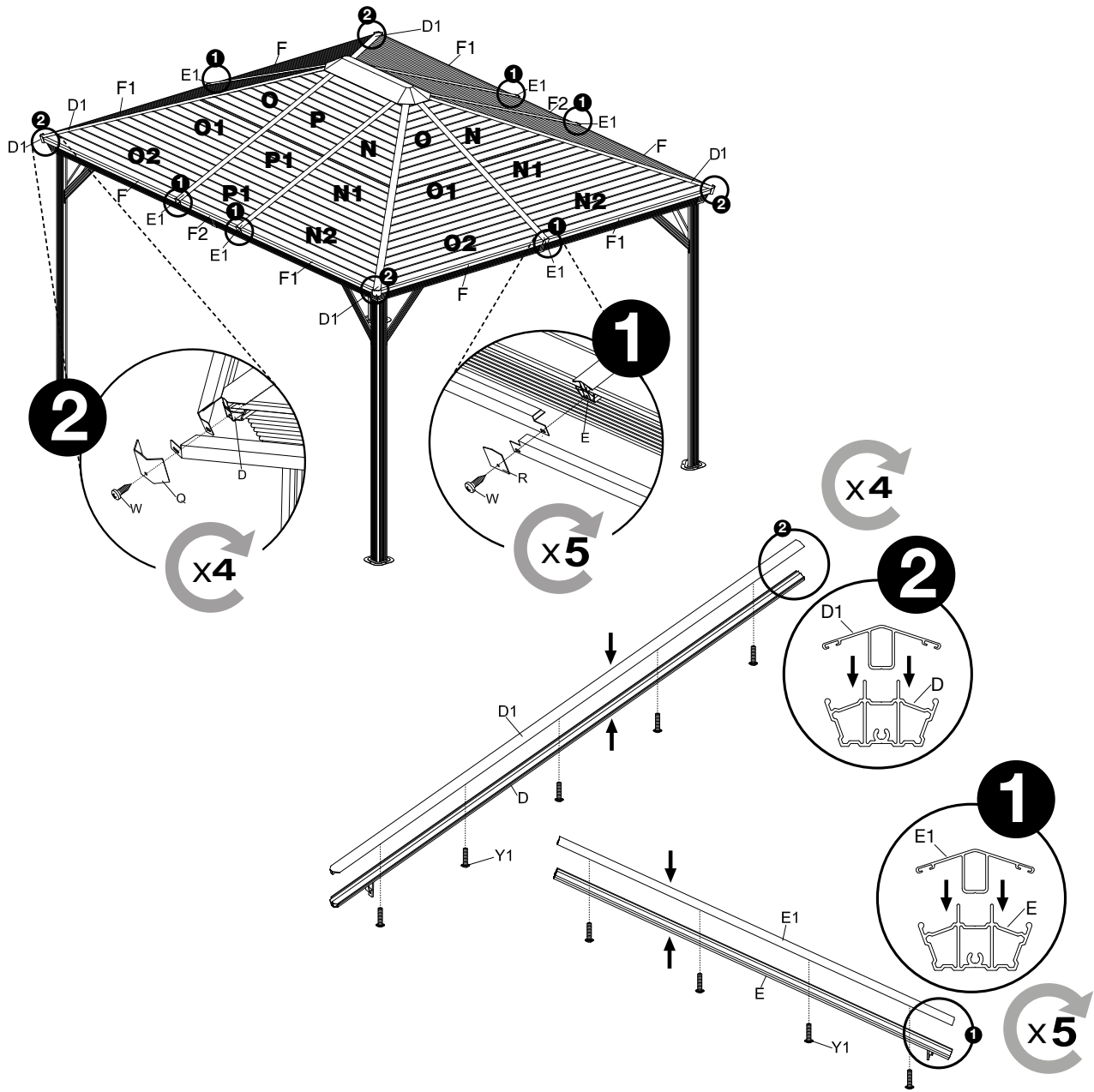

- |  |  |  |             |             |              |
|--|--|--|-------------|-------------|--------------|
|  |  |  | <b>D1x4</b> | <b>F1x4</b> | <b>Rx5</b>   |
|  |  |  | <b>E1x5</b> | <b>F2x1</b> | <b>Wx9</b>   |
|  |  |  | <b>Fx3</b>  | <b>Qx4</b>  | <b>Y1x40</b> |

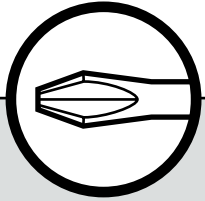

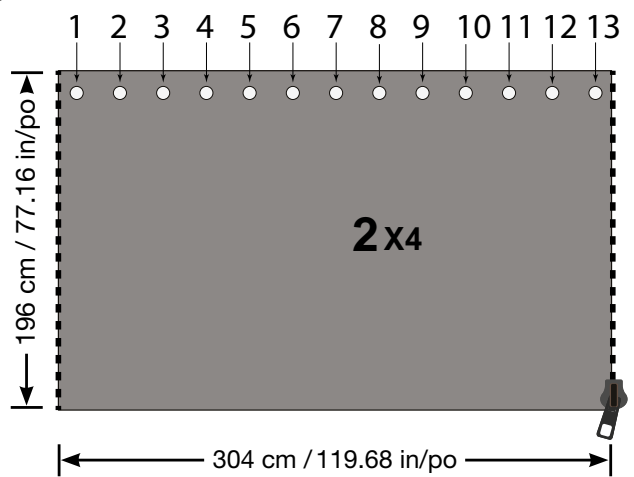
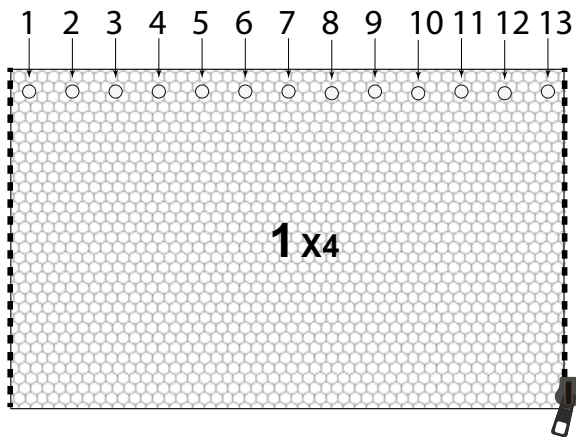
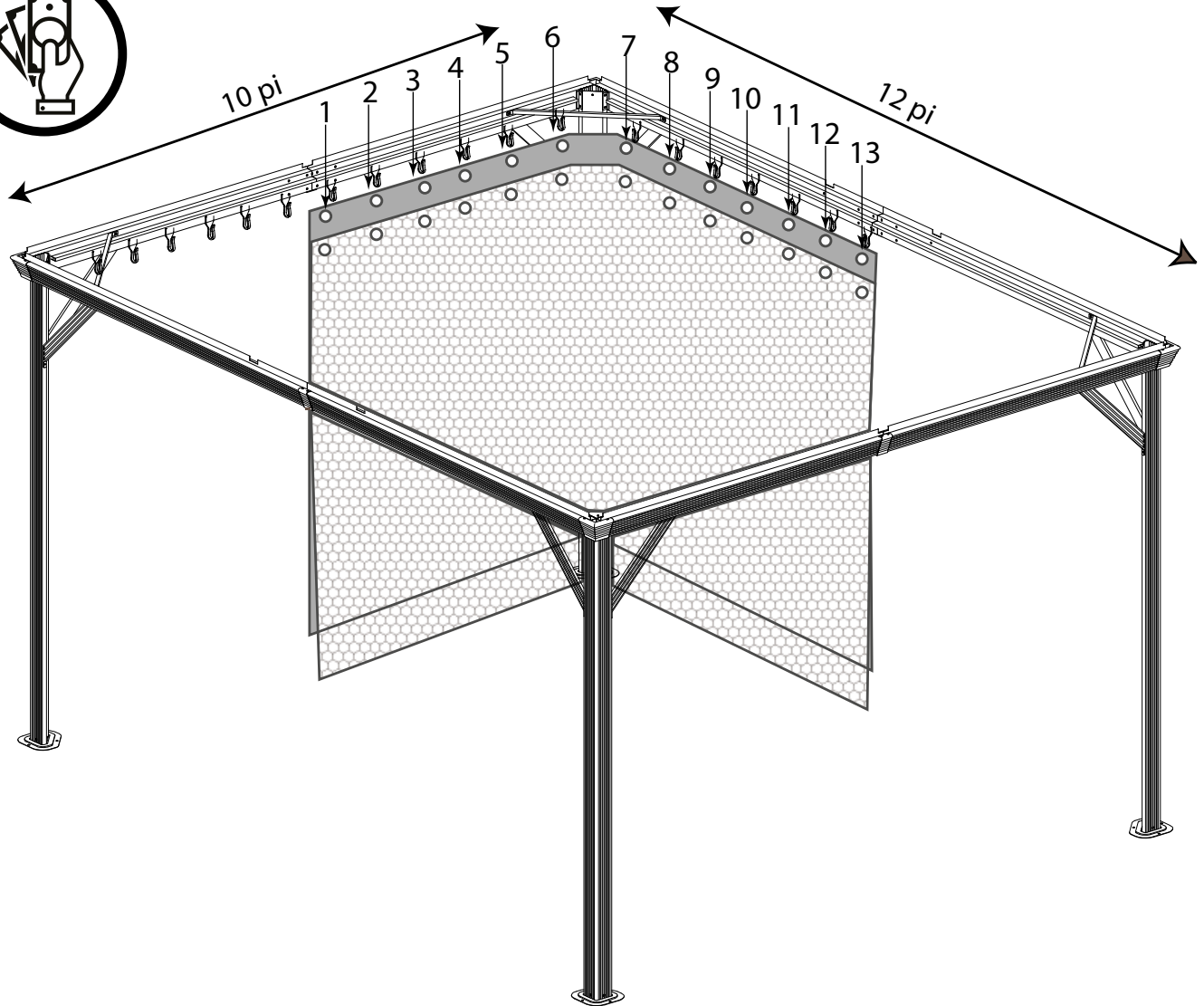
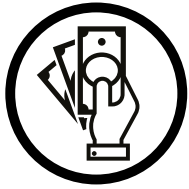







**SOJAG** ■ I  
produits saisonniers • seasonal products