



# UNDER COUNTER BEVERAGE CENTER

## DETAILED PLANNING DIMENSIONS GUIDE

JUBFR242HL, JUBFL242HL, JUBFR242HM, JUBFL242HM, JUBFL242HX, JUBFR242HX  
 23<sup>7</sup>/<sub>8</sub>" (W) x 34<sup>3</sup>/<sub>8</sub>" (H) x 23<sup>1</sup>/<sub>16</sub>" (Depth without door panels/handles)

Choose one of following configuration to match your kitchen design.

Base Unit (Panel Ready)	RISE™ Model	NOIR™ Model
LH: JUBFL242HX RH: JUBFR242HX	LH: JUBFL242HL RH: JUBFR242HL	LH: JUBFL242HM RH: JUBFR242HM

### OPTIONAL ACCESSORIES FOR CUSTOM OVERLAY DESIGNS

#### RISE™ STAINLESS HANDLE KIT

- W11231237
- For use with Custom Overlay panels
- Quantity - One handle per kit

#### NOIR™ STAINLESS HANDLE KIT

- W11231236
- For use with Custom Overlay panels
- Quantity - One handle per kit

Because Whirlpool Corporation policy includes a continuous commitment to improve our products, we reserve the right to change materials and specifications without notice.

Dimensions are for planning purposes only. For complete details, see Installation Instructions packed with product. Specifications subject to change without notice.



# UNDER COUNTER BEVERAGE CENTER

## DETAILED PLANNING DIMENSIONS GUIDE

JUBFR242HL, JUBFL242HL, JUBFR242HM, JUBFL242HM, JUBFL242HX, JUBFR242HX  
 23<sup>7</sup>/<sub>8</sub>" (W) x 34<sup>3</sup>/<sub>8</sub>" (H) x 23<sup>1</sup>/<sub>16</sub>" (Depth without door panels/handles)

### PRODUCT DIMENSIONS

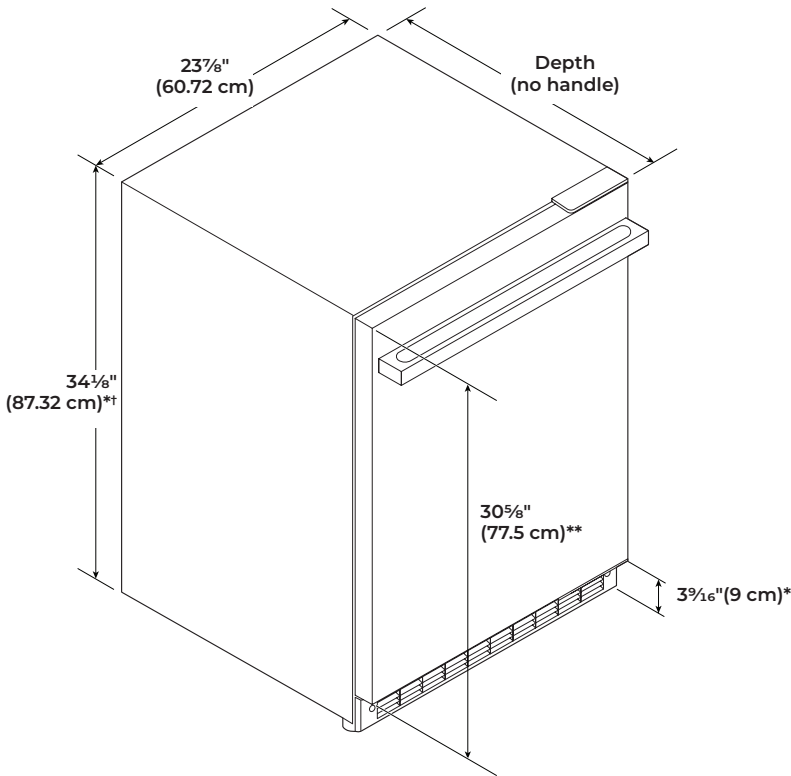

VARIANT	DEPTH (NO HANDLE)
RISE™ Model	23 <sup>13</sup> / <sub>16</sub> " (60.4 cm)
NOIR™ Model	23 <sup>5</sup> / <sub>16</sub> " (60.8 cm)
Panel ready models (with 3/4" panel)	23 <sup>1</sup> / <sub>16</sub> " (60.2 cm)

\*Add 5/8" (1.6 cm) to the height dimension when leveling legs are fully extended.

\*\*For custom panel models, this will vary.

†Add 1/4" (6.4 mm) to the height dimension for height with hinge covers.



# UNDER COUNTER BEVERAGE CENTER

## DETAILED PLANNING DIMENSIONS GUIDE

JUBFR242HL, JUBFL242HL, JUBFR242HM, JUBFL242HM, JUBFL242HX, JUBFR242HX  
 23<sup>7</sup>/<sub>8</sub>" (W) x 34<sup>3</sup>/<sub>8</sub>" (H) x 23<sup>1</sup>/<sub>16</sub>" (Depth without door panels/handles)

DIMENSION	DESCRIPTION	RISE™ Model	NOIR™ Model	Panel ready models (with 3/4" panel)
A	Width of door	23 <sup>3</sup> / <sub>4</sub> " (60.3 cm)		
B	Width of the grille	23 <sup>13</sup> / <sub>16</sub> " (60.5 cm)	23 <sup>13</sup> / <sub>16</sub> " (60.5 cm)	23 <sup>13</sup> / <sub>16</sub> " (60.5 cm)
C	Height to top of handle	28 <sup>7</sup> / <sub>16</sub> " (71.3 cm)	28 <sup>7</sup> / <sub>16</sub> " (71.3 cm)	**
D	Width from side of beverage center to handle - door open 90°	2 <sup>7</sup> / <sub>16</sub> " (6.2 cm)	1 <sup>15</sup> / <sub>16</sub> " (5 cm)	**
E	Depth without door	21 <sup>1</sup> / <sub>16</sub> " (55.1 cm)		
F	Depth with door	23 <sup>13</sup> / <sub>16</sub> " (60.4 cm)	23 <sup>15</sup> / <sub>16</sub> " (60.8 cm)	23 <sup>11</sup> / <sub>16</sub> " (60.2 cm)
G	Depth with handle	26 <sup>9</sup> / <sub>16</sub> " (67.5 cm)	26 <sup>7</sup> / <sub>8</sub> " (66.3 cm)	**
H	Depth with door open 90°	48" (121.9 cm)		47 <sup>15</sup> / <sub>16</sub> " (121.8 cm)

\*\*For custom panel models, this will vary.

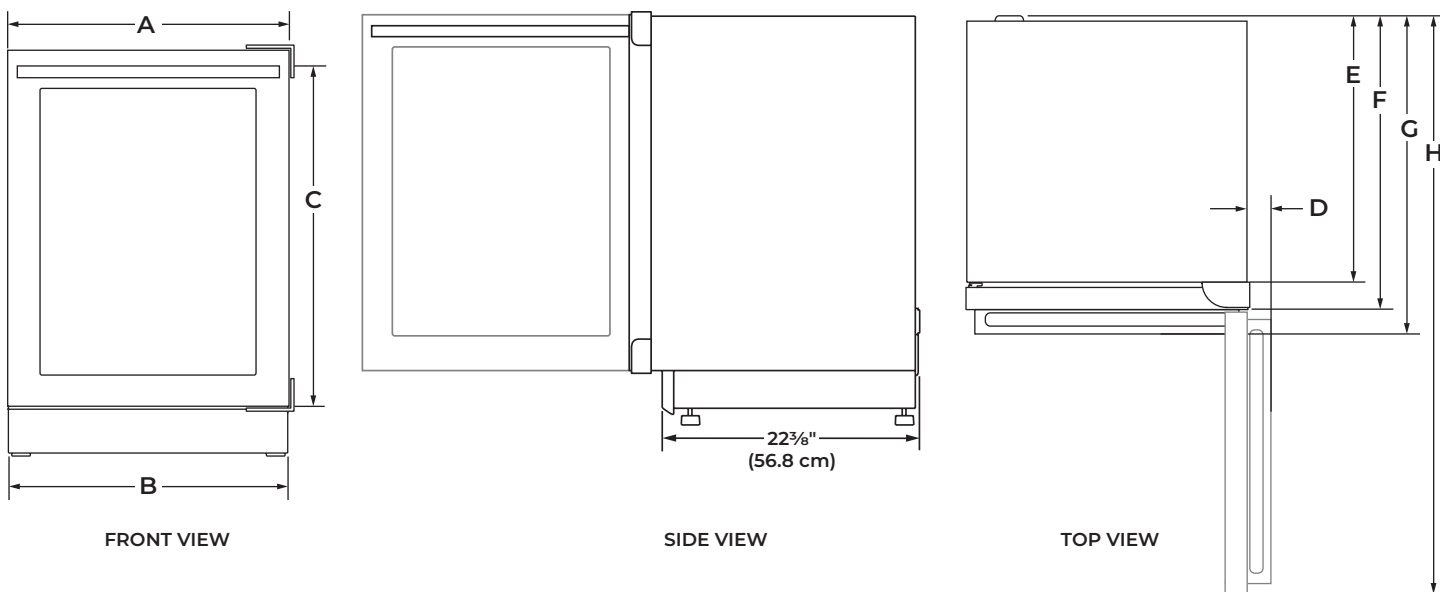

Because Whirlpool Corporation policy includes a continuous commitment to improve our products, we reserve the right to change materials and specifications without notice.

Dimensions are for planning purposes only. For complete details, see Installation Instructions packed with product. Specifications subject to change without notice.



# UNDER COUNTER BEVERAGE CENTER

## DETAILED PLANNING DIMENSIONS GUIDE

JUBFR242HL, JUBFL242HL, JUBFR242HM, JUBFL242HM, JUBFL242HX, JUBFR242HX  
 23<sup>7</sup>/<sub>8</sub>" (W) x 34<sup>3</sup>/<sub>8</sub>" (H) x 23<sup>1</sup>/<sub>16</sub>" (Depth without door panels/handles)

### OPENING DIMENSIONS

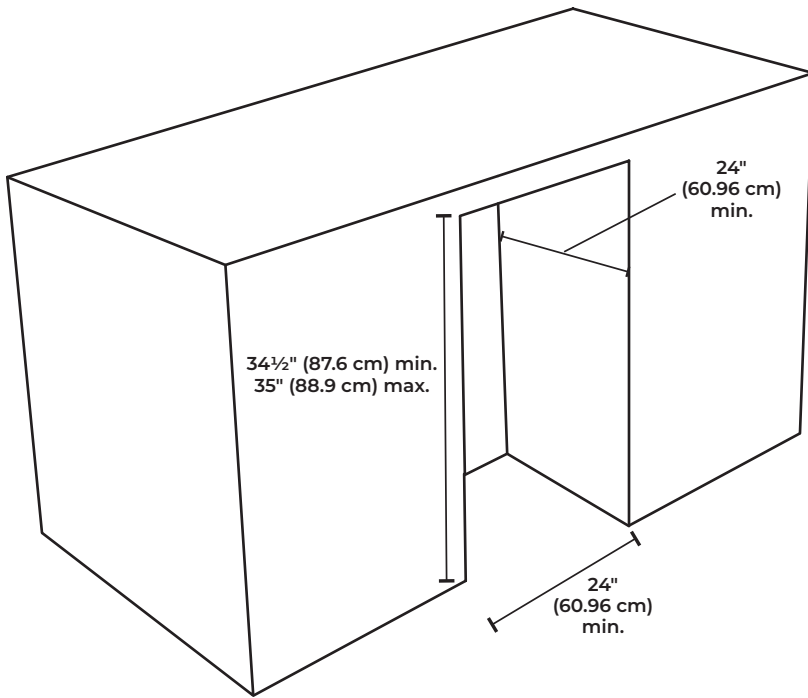

**NOTE:** Make sure there is 3" (7.6 cm) space between beverage center and adjacent appliance/wall for door swing.

### ELECTRICAL SUPPLY LOCATION

- Lighter yellow area indicates recommended recessed power outlet (located behind the beverage center).
- Power cord length is 5 ft (152.4 cm).
- For flush installation, the power outlet can be installed in adjacent cabinetry with a cutout on the power cord side for routing of the power cord.

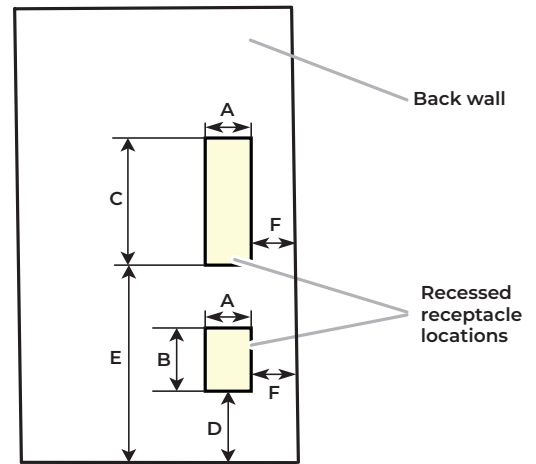

Dimension - A	3" (7.55 cm)
Dimension - B	4 <sup>1</sup> / <sub>2</sub> " (11.37 cm)
Dimension - C	9 <sup>1</sup> / <sub>4</sub> " (23.47 cm)
Dimension - D	12 <sup>3</sup> / <sub>16</sub> " (30.64 cm)
Dimension - E	21 <sup>3</sup> / <sub>4</sub> " (55.16 cm)
Dimension - F	1 <sup>3</sup> / <sub>4</sub> " (4.44 cm)



# UNDER COUNTER BEVERAGE CENTER

## DETAILED PLANNING DIMENSIONS GUIDE

JUBFR242HL, JUBFL242HL, JUBFR242HM, JUBFL242HM, JUBFL242HX, JUBFR242HX  
23<sup>7</sup>/<sub>8</sub>" (W) x 34<sup>3</sup>/<sub>8</sub>" (H) x 23<sup>1</sup>/<sub>16</sub>" (Depth without door panels/handles)

### ELECTRICAL REQUIREMENTS

<b>⚠ WARNING</b>

<b>Electrical Shock Hazard</b> Plug into a grounded 3 prong outlet. Do not remove ground prong. Do not use an adapter. Do not use an extension cord. <b>Failure to follow these instructions can result in death, fire, or electrical shock.</b>

A 115 V, 60 Hz, AC only, 15 A or 20 A fused, grounded electrical supply is required. It is recommended that a separate circuit serving only your beverage center be provided. Use an outlet that cannot be turned off by a switch. Do not use an extension cord.

### LOCATION REQUIREMENTS

<b>⚠ WARNING</b>

<b>Explosion Hazard</b> Keep flammable materials and vapors, such as gasoline, away from beverage center. <b>Failure to do so can result in death, explosion, or fire.</b>

For the beverage center to be flush with the front of the base cabinets, remove any baseboards or moldings from the rear of the opening.

Flooring under product must be at the same level as the room. If the floor of the opening is not level with the kitchen floor, shim the opening to make it level with the kitchen floor.



# UNDER COUNTER BEVERAGE CENTER

## DETAILED PLANNING DIMENSIONS GUIDE

JUBFR242HL, JUBFL242HL, JUBFR242HM, JUBFL242HM, JUBFL242HX, JUBFR242HX  
 23<sup>7</sup>/<sub>8</sub>" (W) x 34<sup>3</sup>/<sub>8</sub>" (H) x 23<sup>1</sup>/<sub>16</sub>" (Depth without door panels/handles)

### WOOD PANEL GUIDE

#### ⚠ CAUTION

##### Pinch Hazard

Installation of door panels with less than a <sup>3</sup>/<sub>8</sub>" (0.95 cm) gap between the door panel and the adjacent cabinet increases the risk of potential pinching.

#### IMPORTANT:

- The graphics in following sections show a custom panel for a door with the hinges installed on the right-hand side. If your beverage center has the hinges installed on the left-hand side, rotate the custom frame 180° so the hinge markings will be on the left.
- Panel dimensions shown are the minimum size to cover the appliance door. Panels can be made taller/wider to match surrounding cabinetry.
- The recommended thickness of the overlay panel is 3/4" (19 mm).
- Custom solid door overlay panel must not weigh more than 20 lbs (9.07 kg).
- Custom glass door overlay panel must not weigh more than 10 lbs (4.54 kg).
- Overlay panels weighing more than recommended may cause damage to your appliance.

### SOLID DOOR OVERLAY PANEL

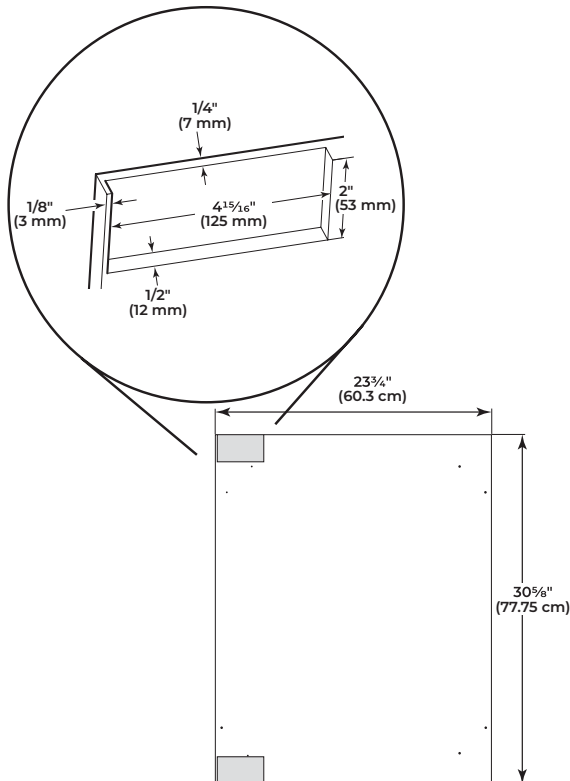

Solid door overlay panel and hinge routing dimensions

### GLASS DOOR OVERLAY PANEL

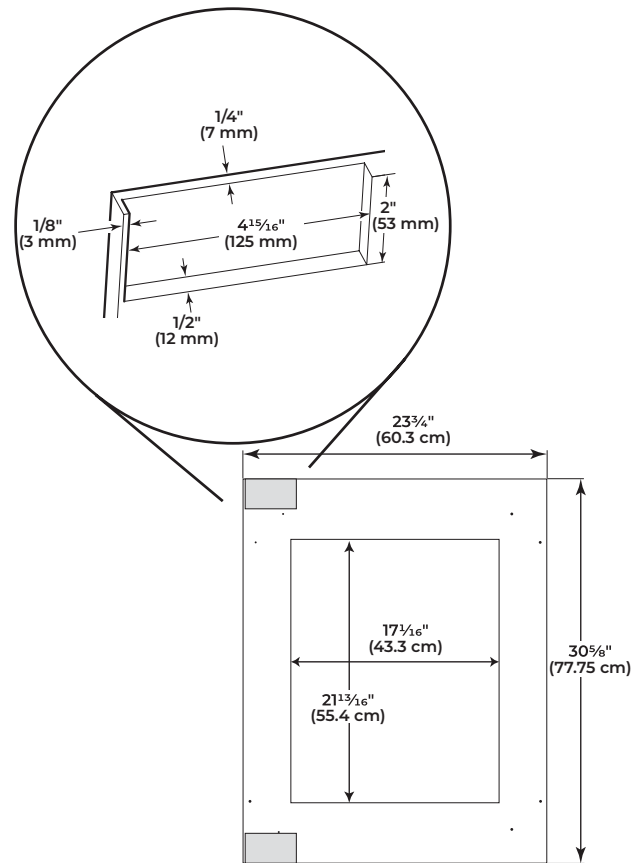

Glass door overlay panel and hinge routing dimensions