

SOJAG

produits saisonniers • seasonal products

QUESTIONS? 1 866-901-1649

Assembly Manual / Guide d'assemblage / Manual de ensamblaje / 조립설명서 / Montageanleitung

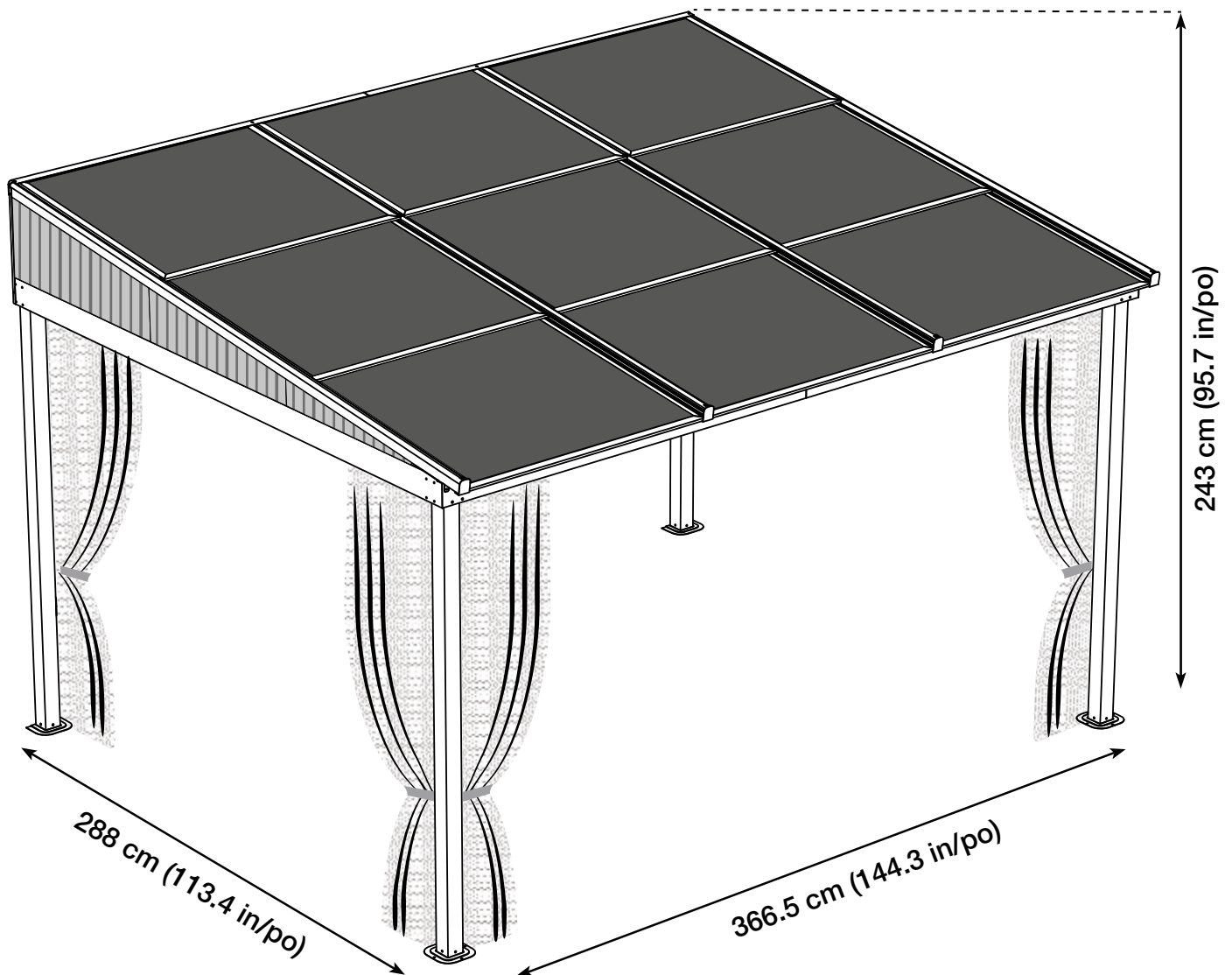

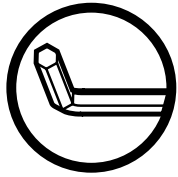

Use the hex keys in the box. / Utilisez les clés hexagonales fournies dans la boîte. / Utilice las llaves hexagonales en la caja. / 상자에 육각 키를 사용 하십시오. / Verwenden Sie die Sechskantschlüssel in der Box.

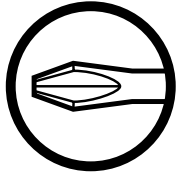

Please use a Phillips screwdriver. / Utilisez un tournevis de type Phillips / Por favor, use un destornillador Phillips. / 십자 드라이버를 사용 하십시오. / Bitte verwenden Sie einen Kreuzschraubenzieher.



You may need to use a drill for this step. / Vous pouvez avoir besoin d'utiliser une perceuse pour cette étape. / Puede que tenga que utilizar un taladro para este paso. / 이 단계에선 드릴을 사용해야 할 수도 있습니다. / Für diesen Schritt können Sie einen Bohrer verwenden.



Wearing protective gloves is recommended. / Le port de gants de protection est recommandé / El uso de guantes de protección se recomienda. / 보호 장갑을 착용 하는 것이 좋습니다. / Das Tragen von Schutzhandschuhen wird empfohlen.



Two or more people are required at this stage. / Deux personnes ou plus sont nécessaires à cette étape. / Dos o más personas se requieren en esta etapa. / 이 단계에서는 두 명 이상 이 필요합니다. / Für diesen Bauschritt sind 2 oder mehr Personen erforderlich.



Do not tighten screws all the way for now. / Ne pas visser fermement pour l'instant. / No atornille con firmeza por ahora. / 아직 나사를 단단히 조이지 마십시오. / Bitte die Schrauben zum jetzigen Zeitpunkt noch nicht fest anziehen.

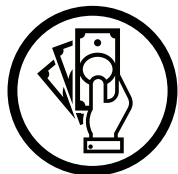

Sold separately. / Vendus séparément. / vendido en las opciones. / 옵션 판매 / Optional erhältlich



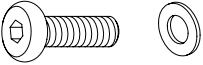
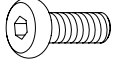

Optional step / Étape optionnelle / Paso opcional / 선택적 단계 / Optionaler Schritt

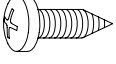
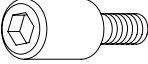

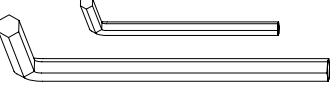
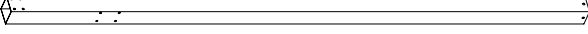
U X4 (+2) 	W X108 (+10) 
--	---

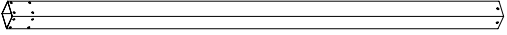
W1 X4 (+2) 	X X32 (+3) 
---	---

Z X1 	A X1 
---	--

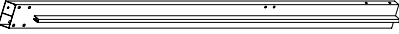
A1 X1 	B X2 
--	--

C X1 	C1 X1 
---	---

D X1 	D1 X1 
---	---

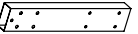
E X2 	E1 X1 
---	--

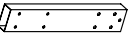
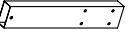
E2 X1 	E3 X1 
--	--

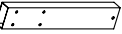
E4 X1 
--

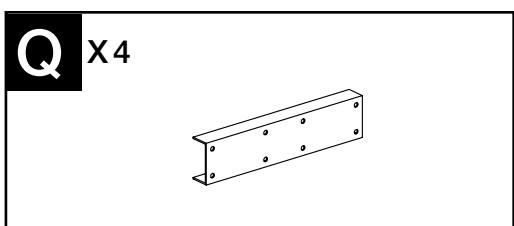
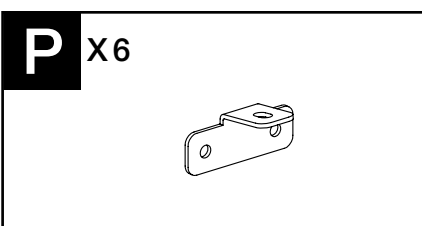
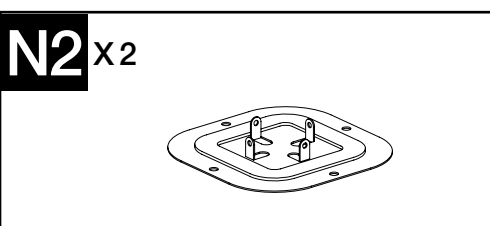
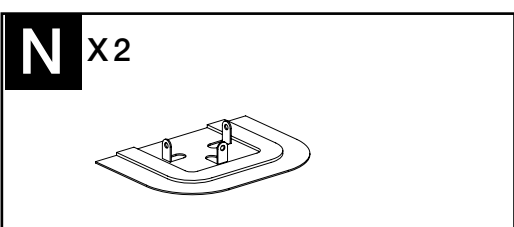
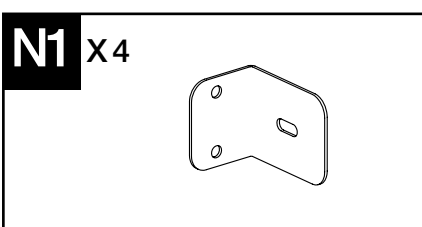
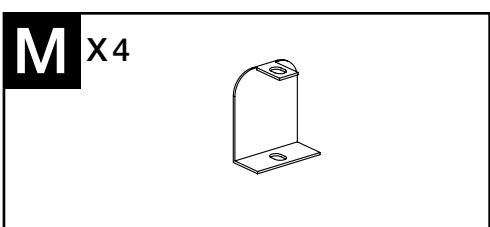
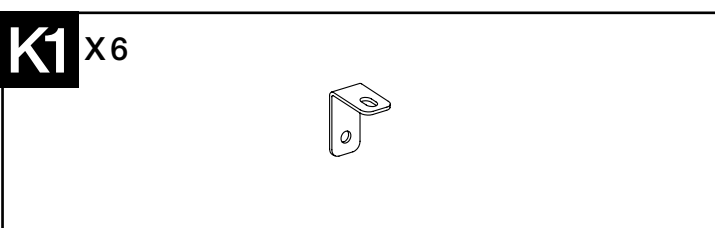
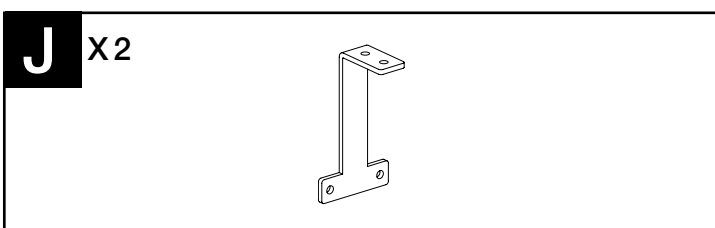
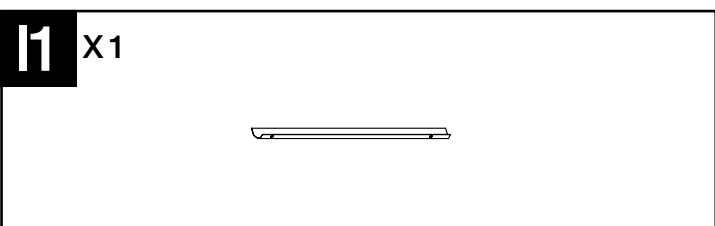
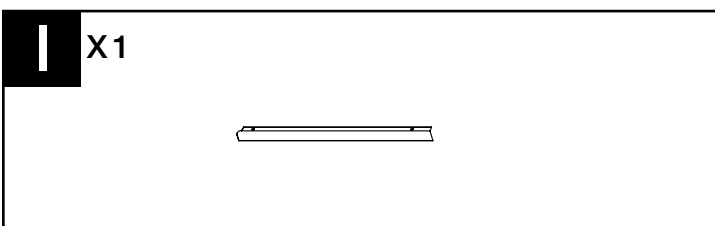
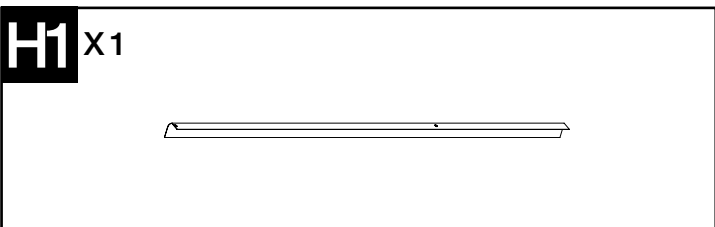
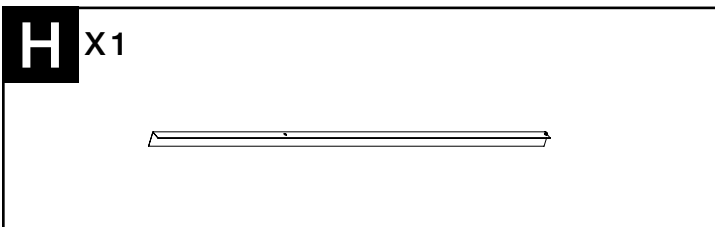
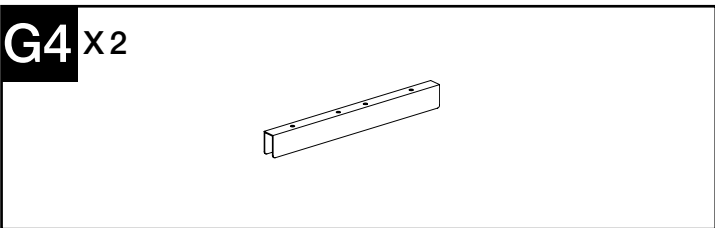
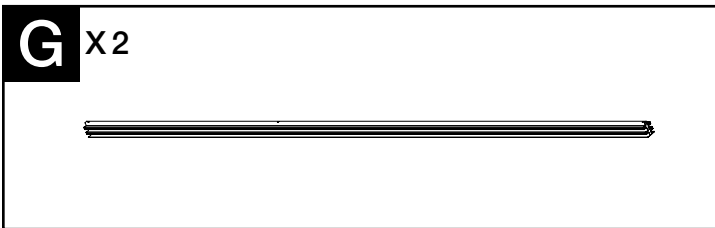
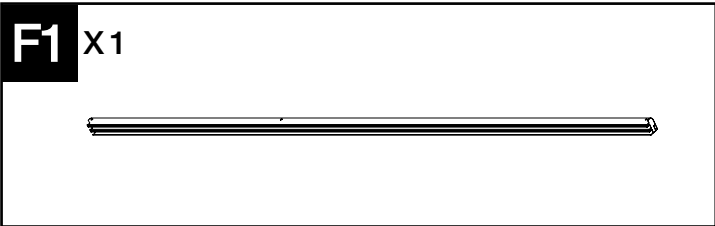
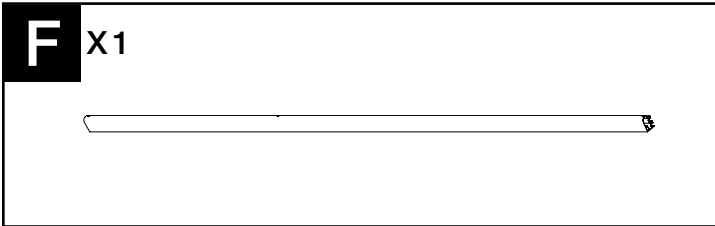

K1a x1

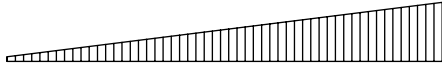

K1b x1



K2a x1

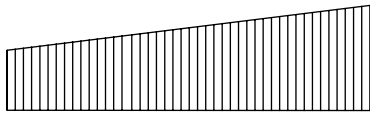

K2b x1

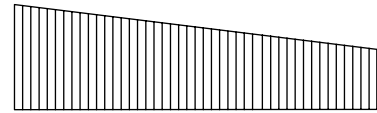

K3a x1

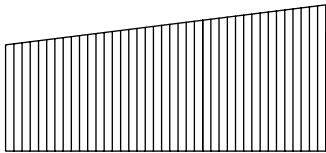

K3b x1

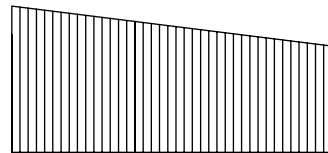

R3a x3

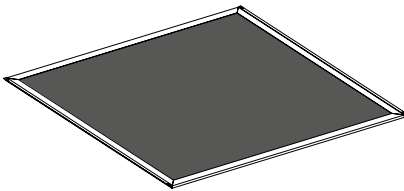

R3b x3

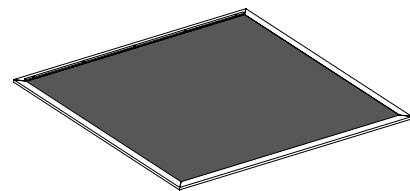

R3c x3

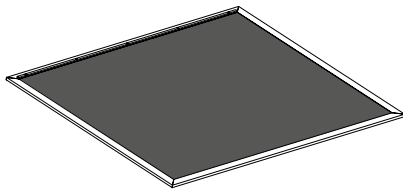

RR X 38(+2) optional **RR** X 38(+2) optional



Net

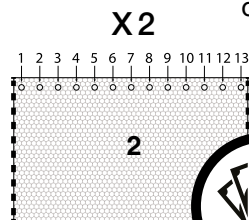
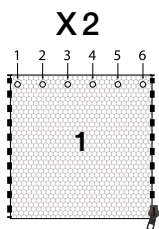

optional



Curtain

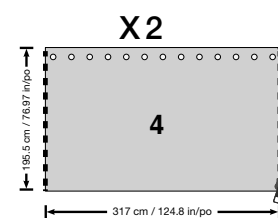
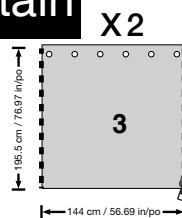

optional

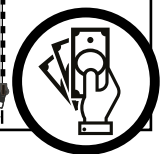

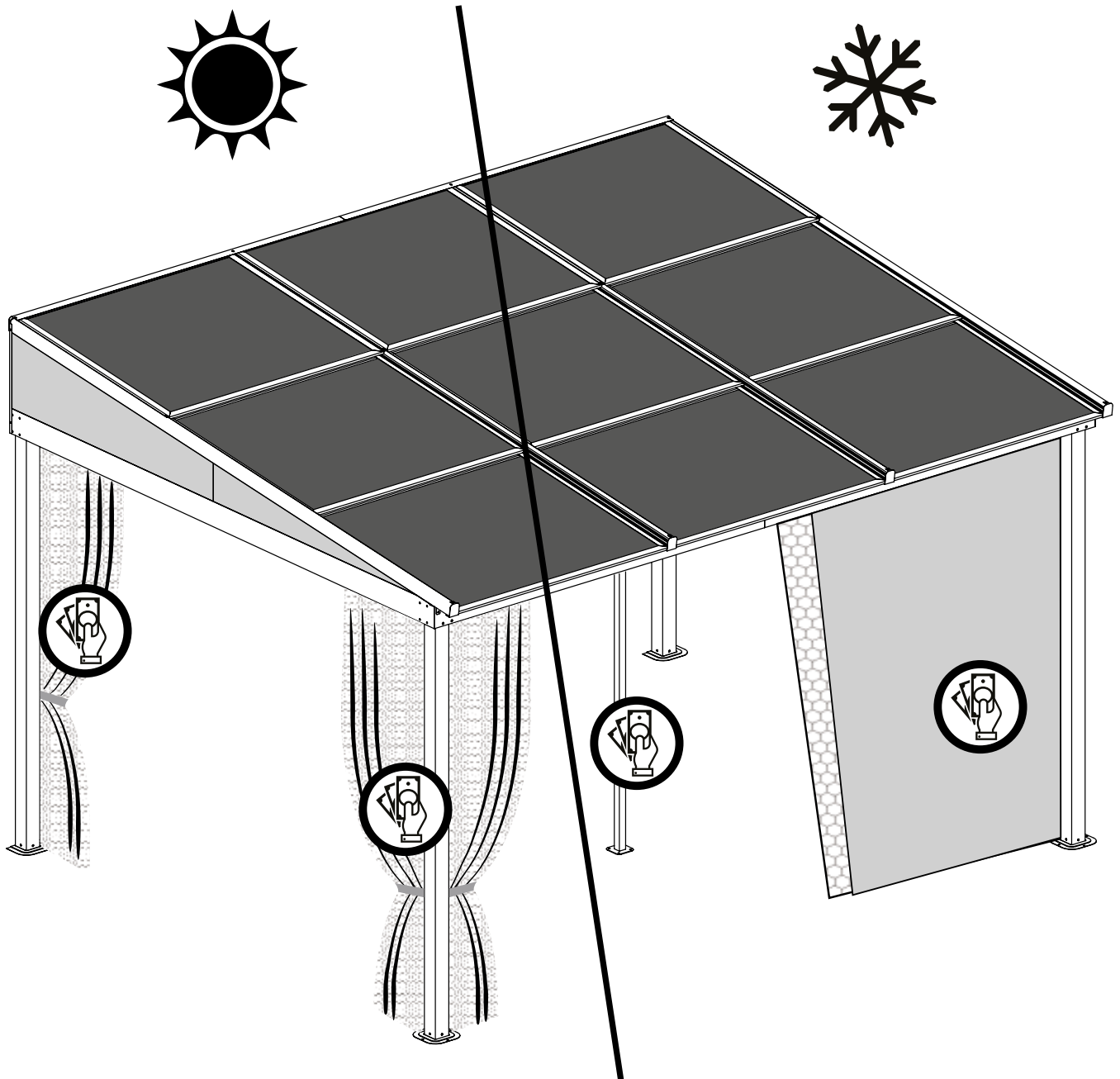
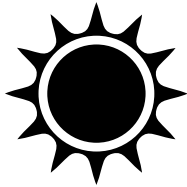
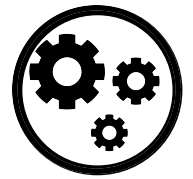

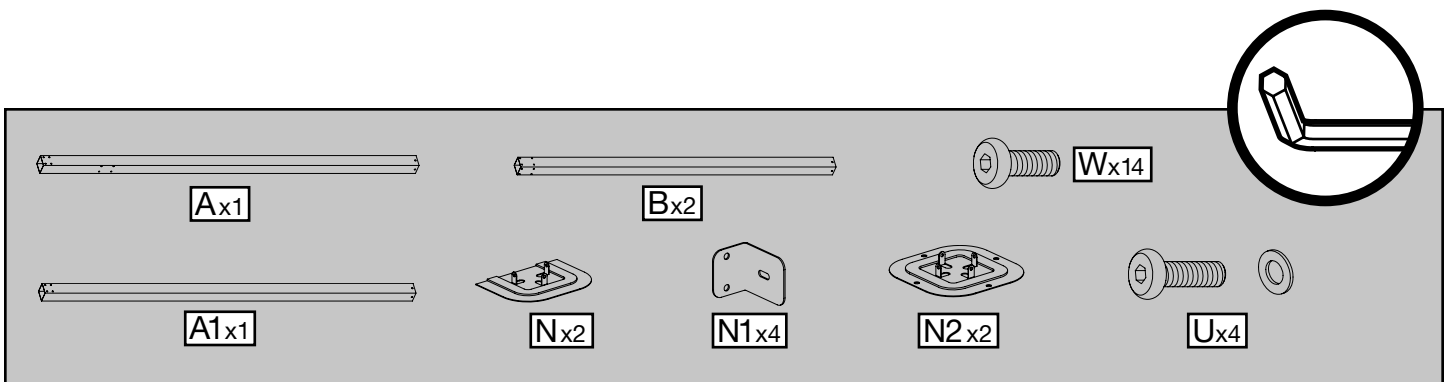
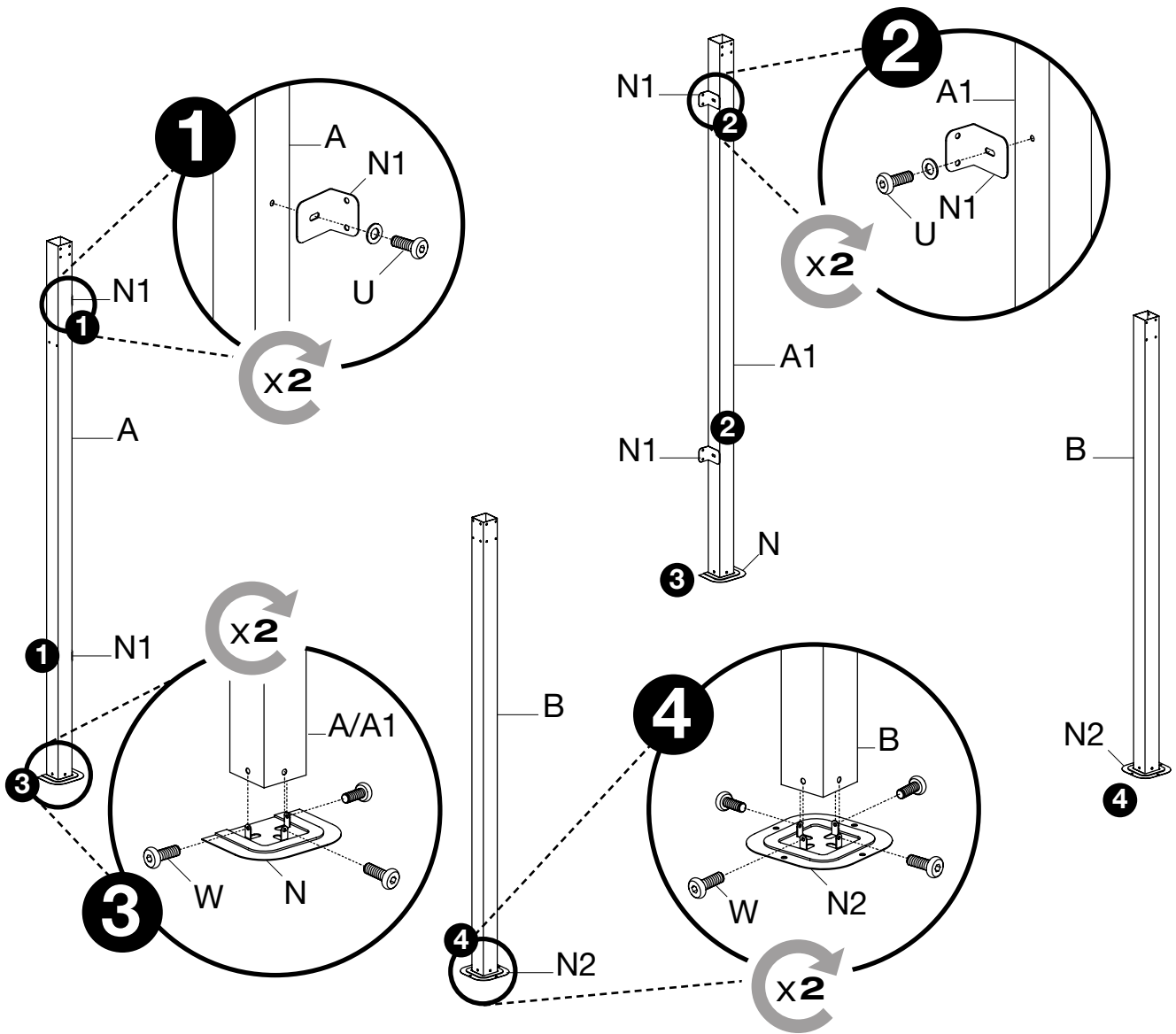

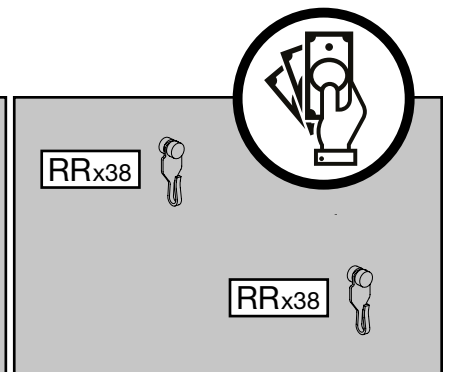
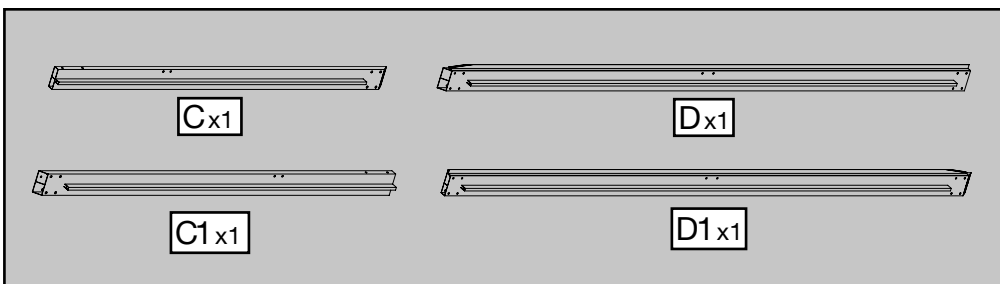
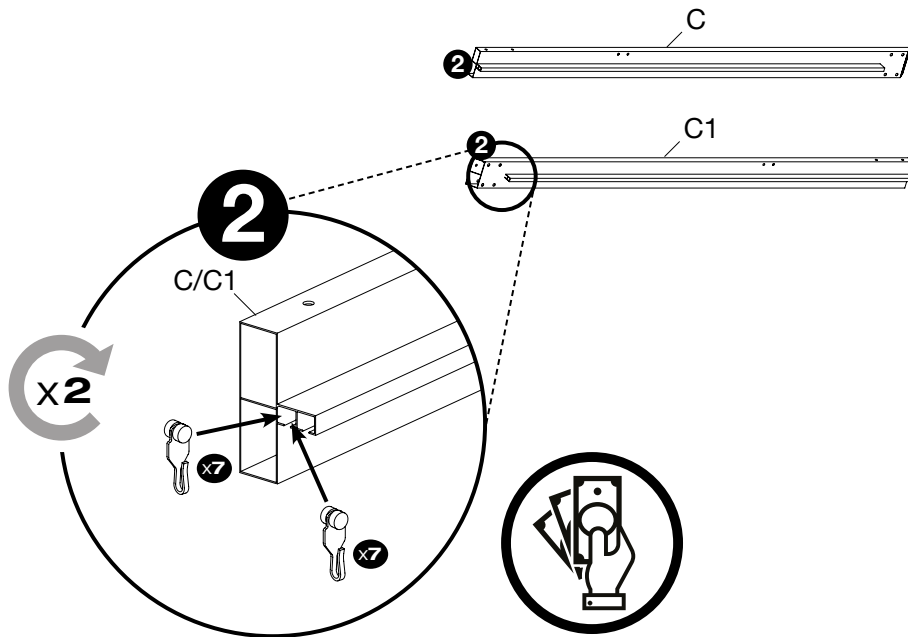
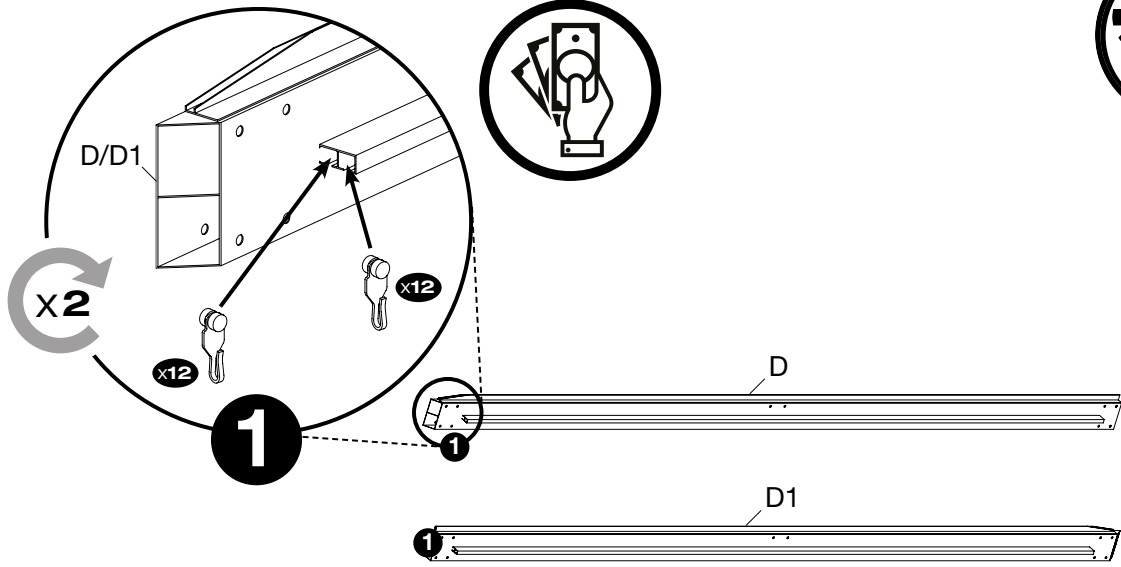
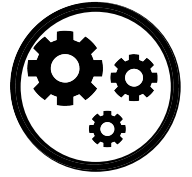

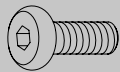
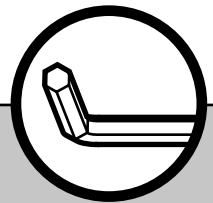
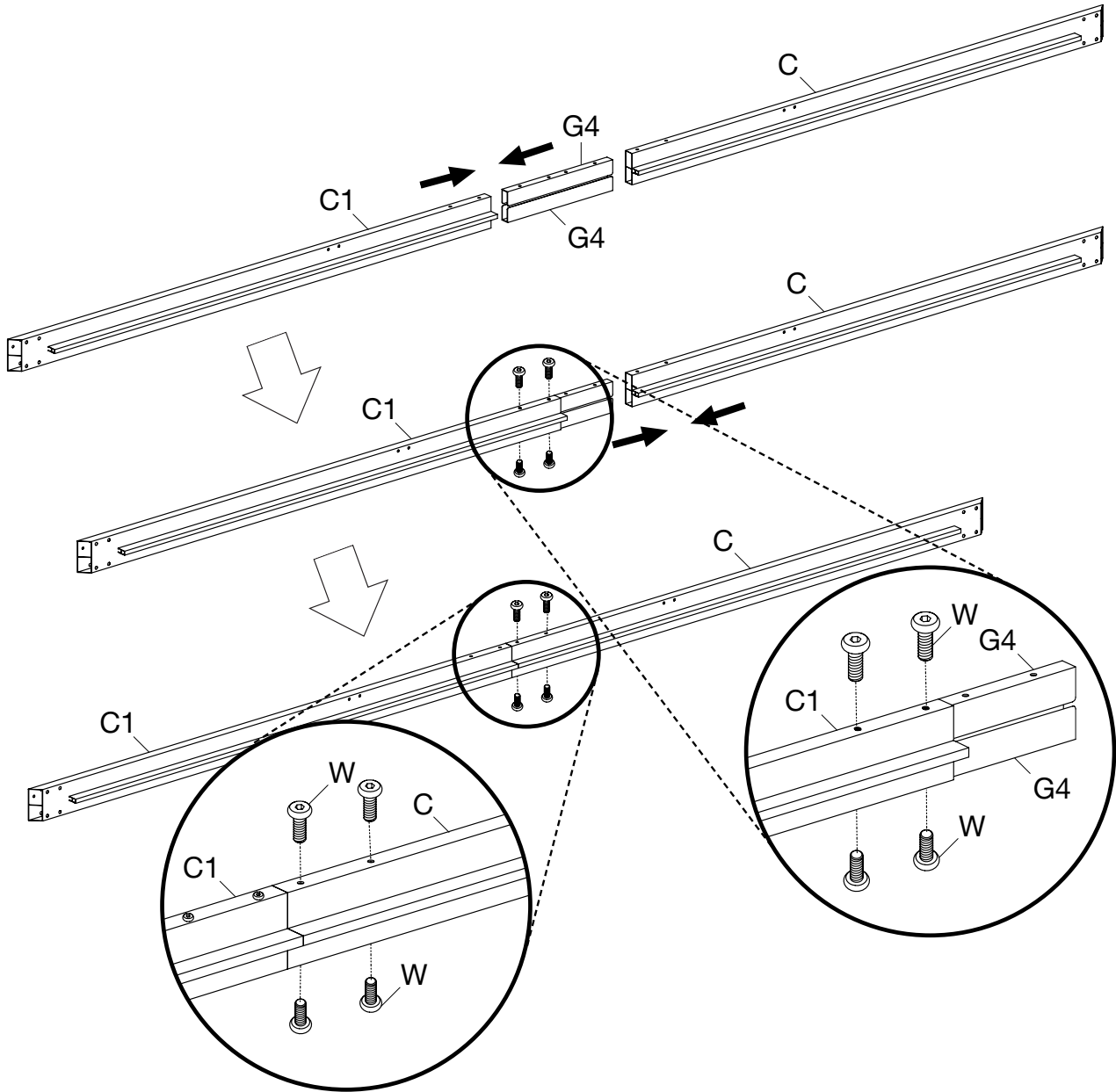



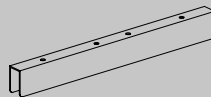

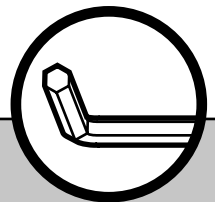
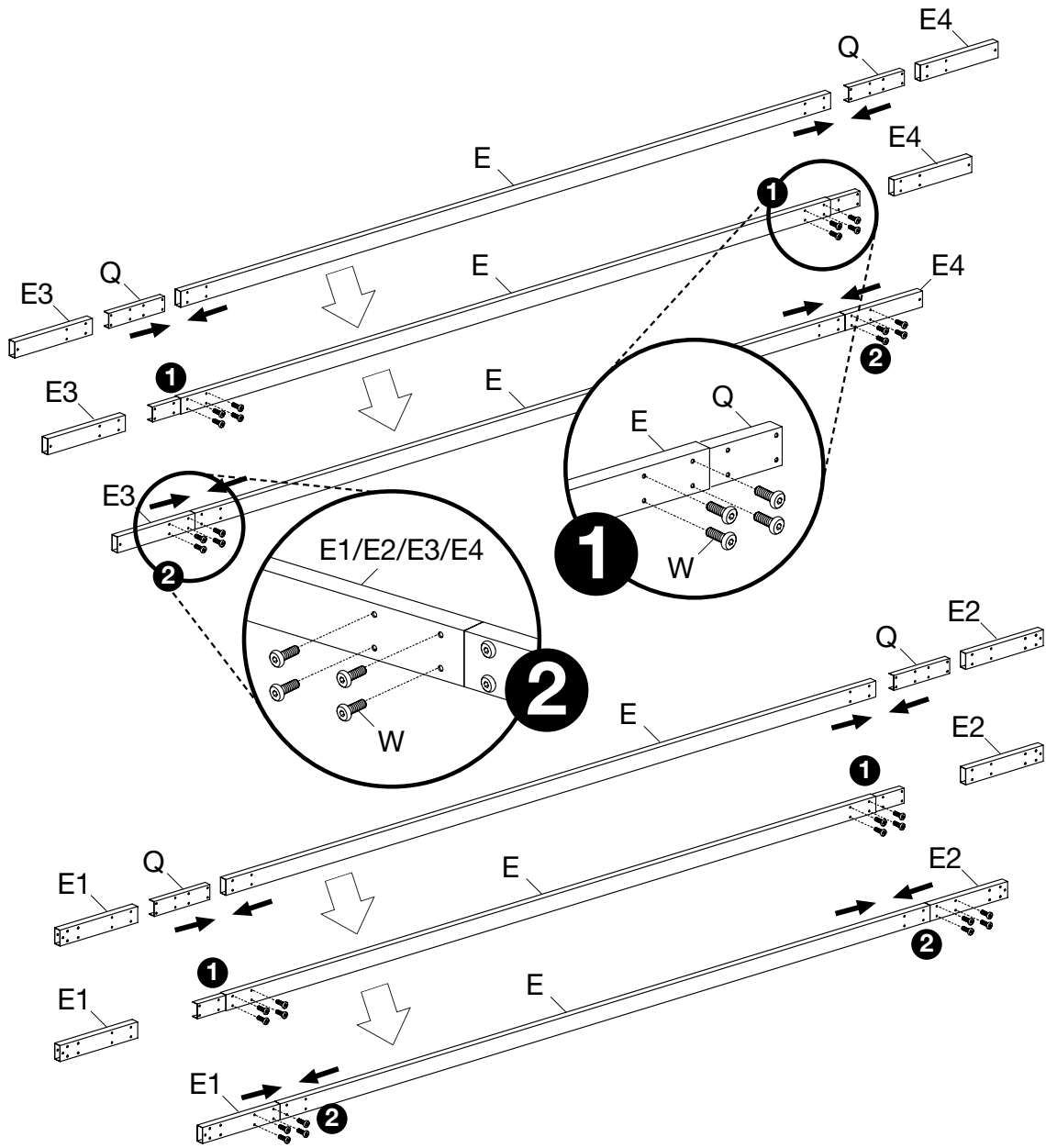

Wx8

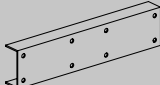

G4x2

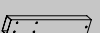
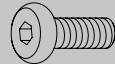

					
E_{x2}					
					
Q_{x4}	E_{1x1}	E_{2x1}	E_{3x1}	E_{4x1}	W_{x32}

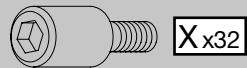
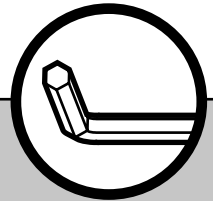
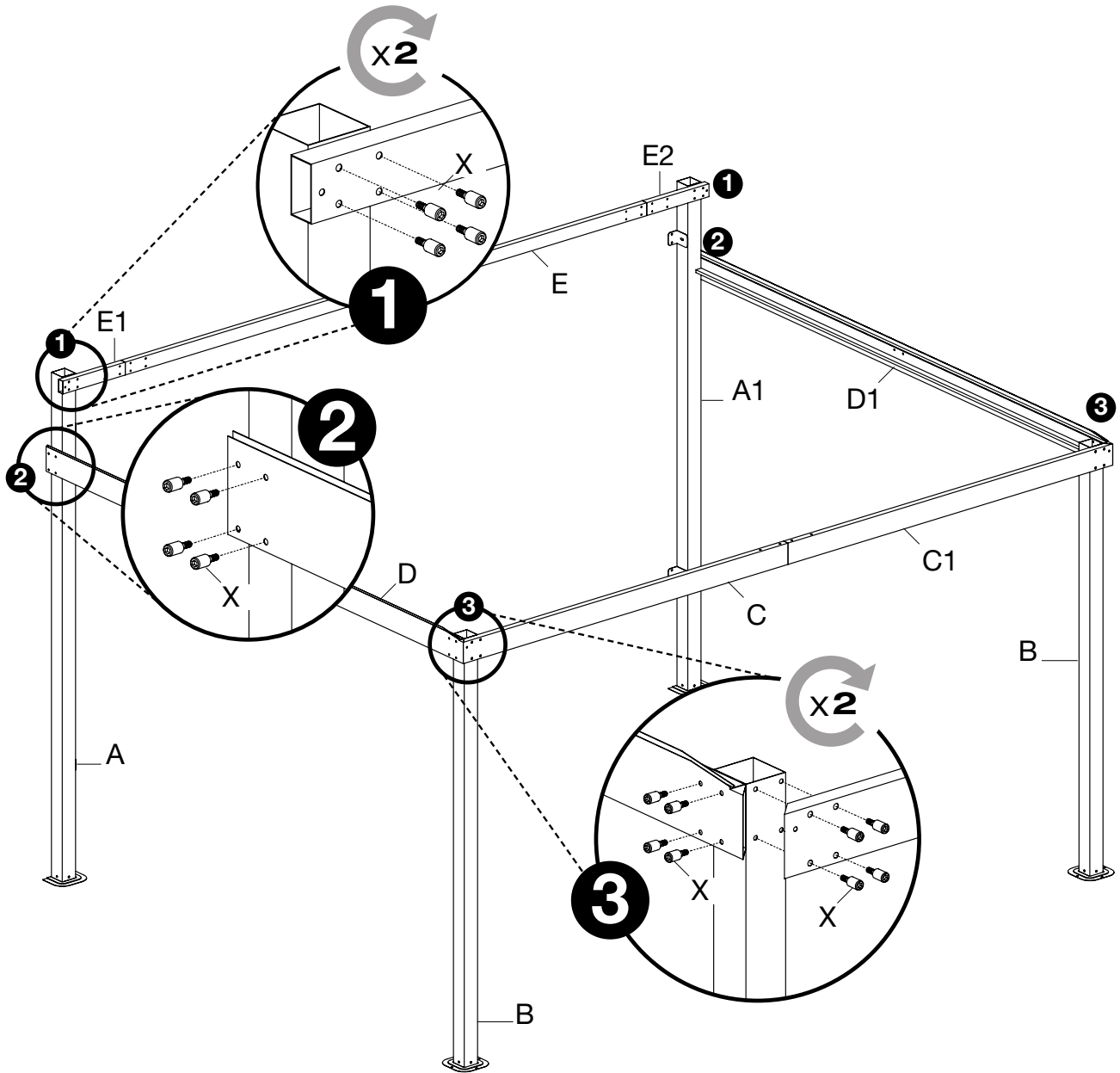

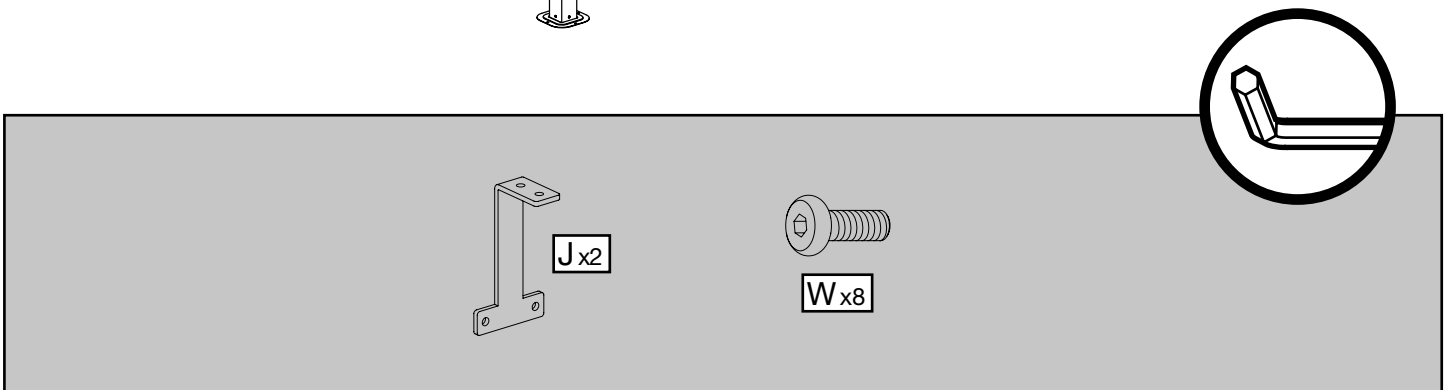
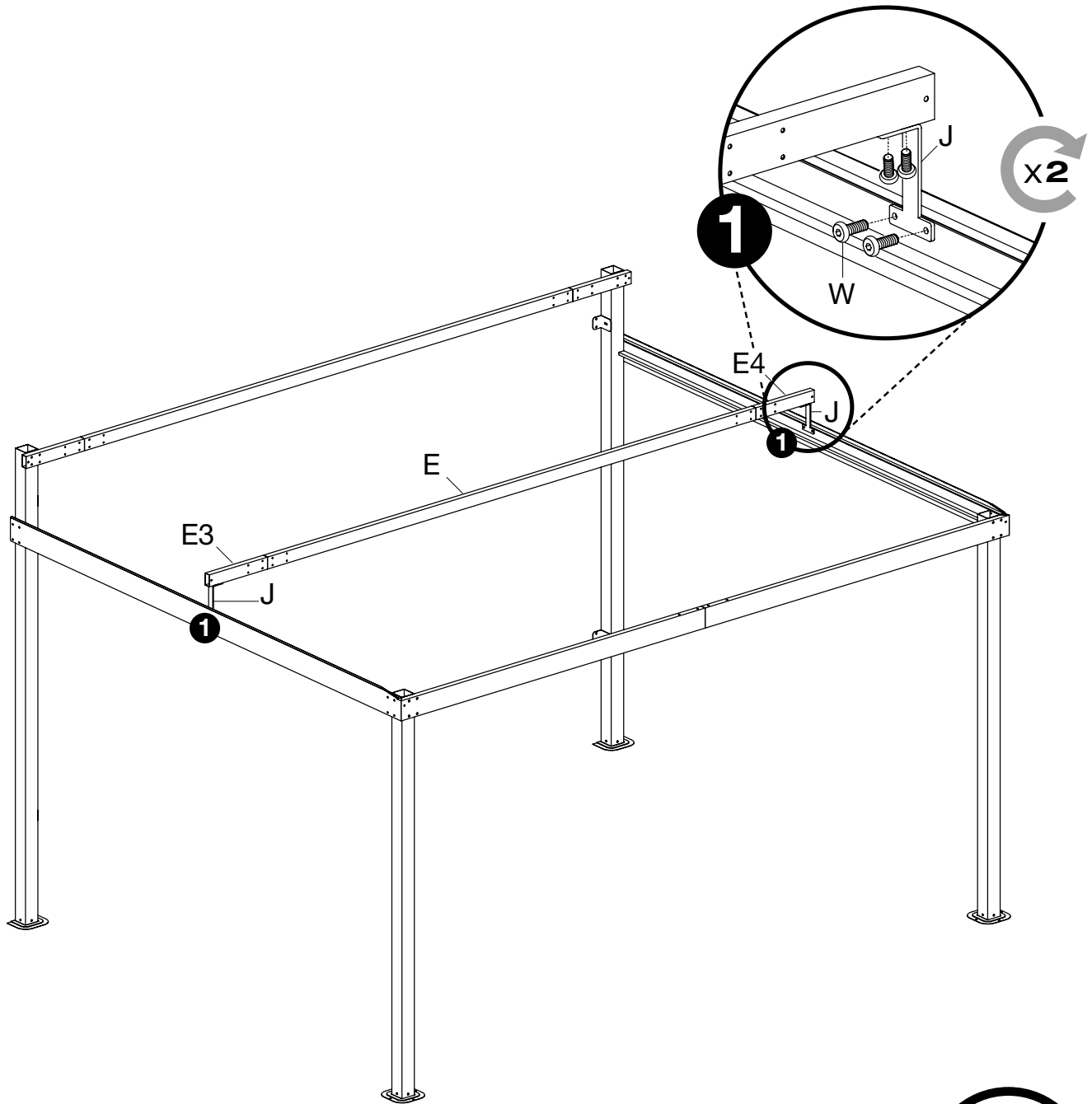

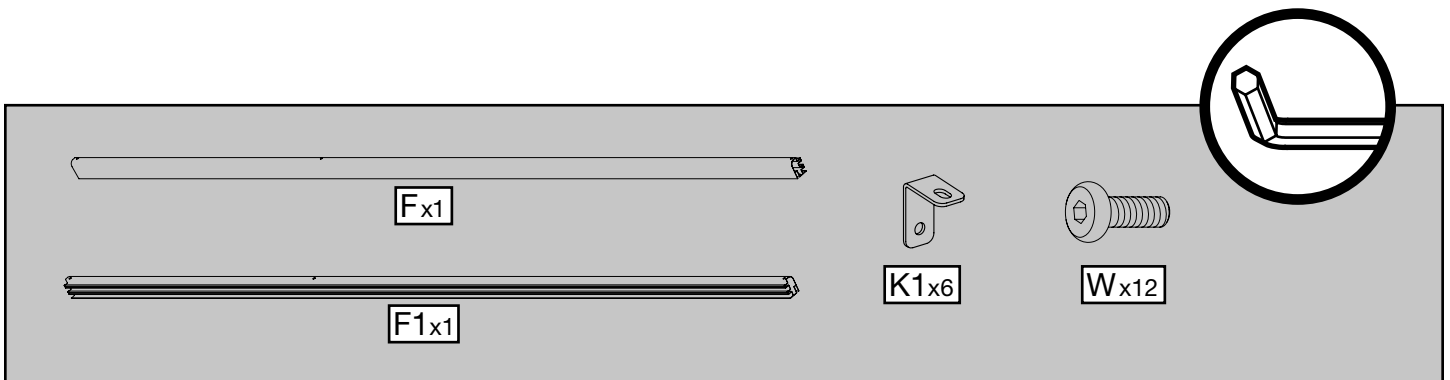
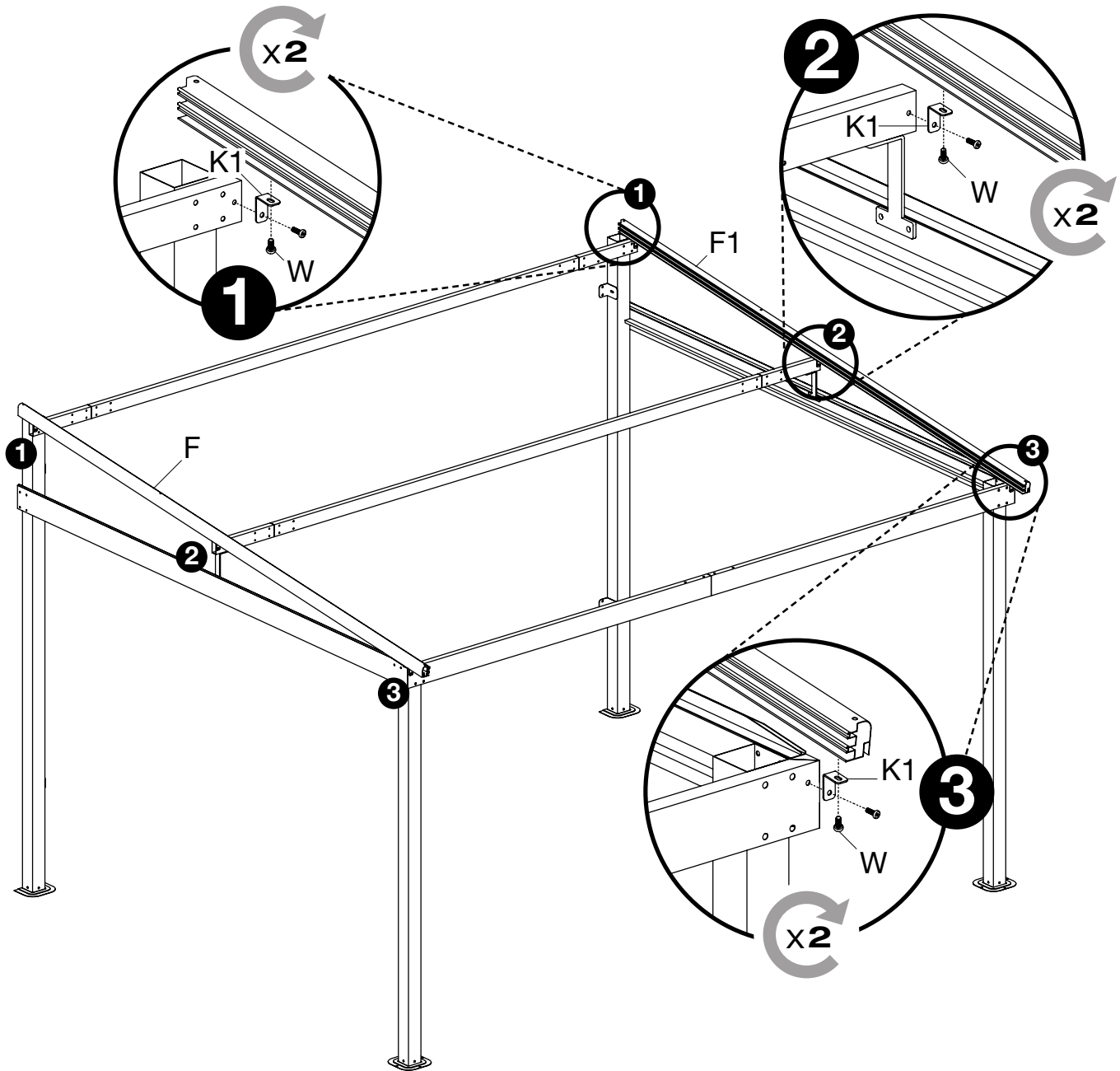

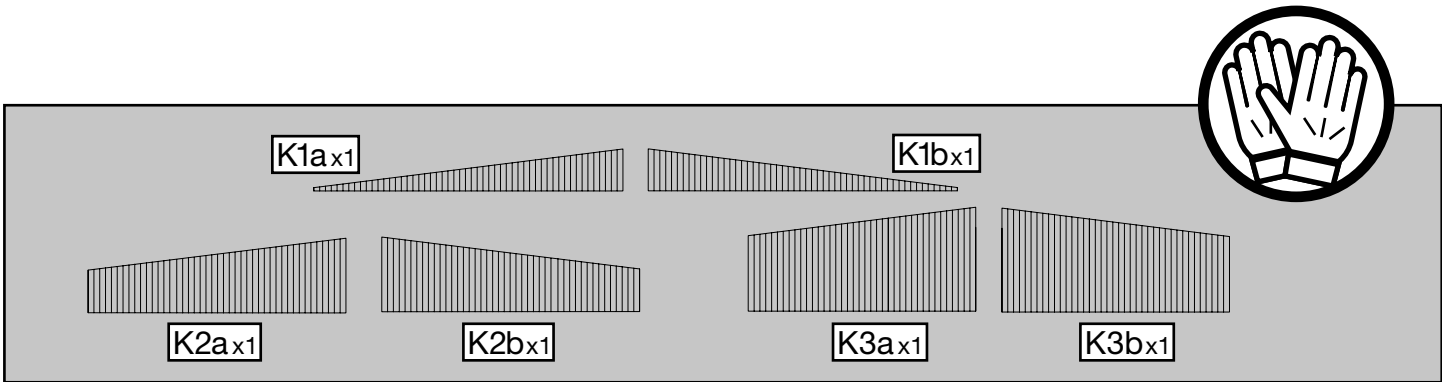
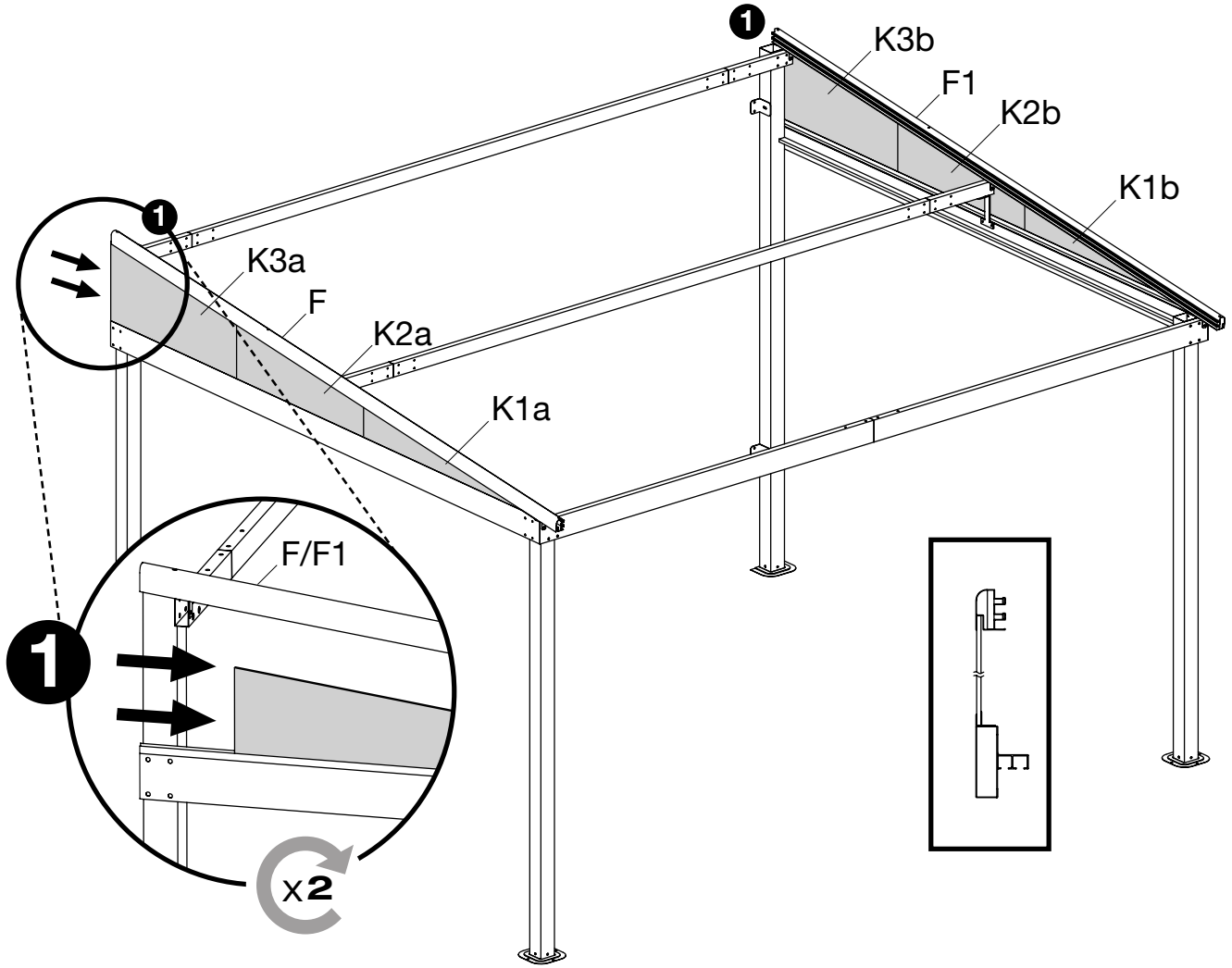

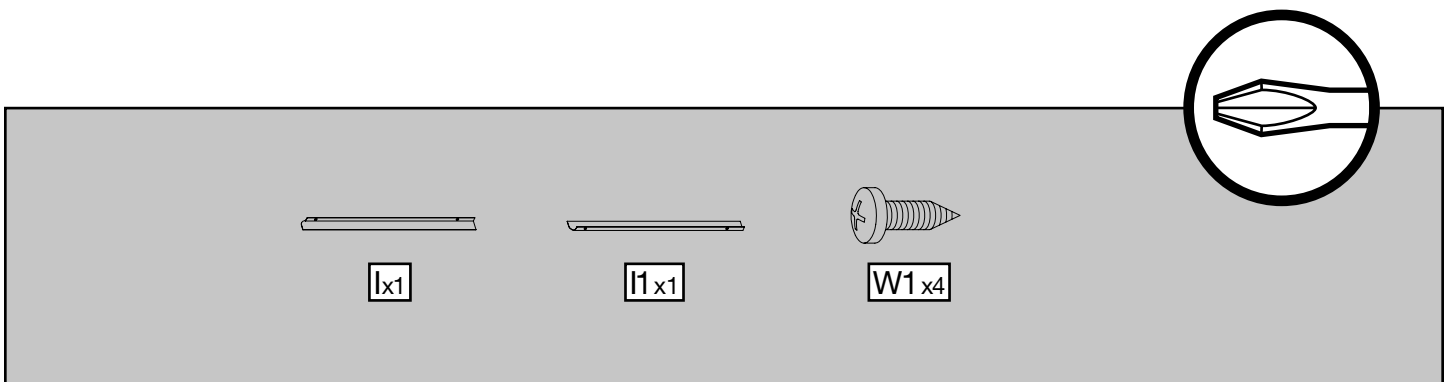
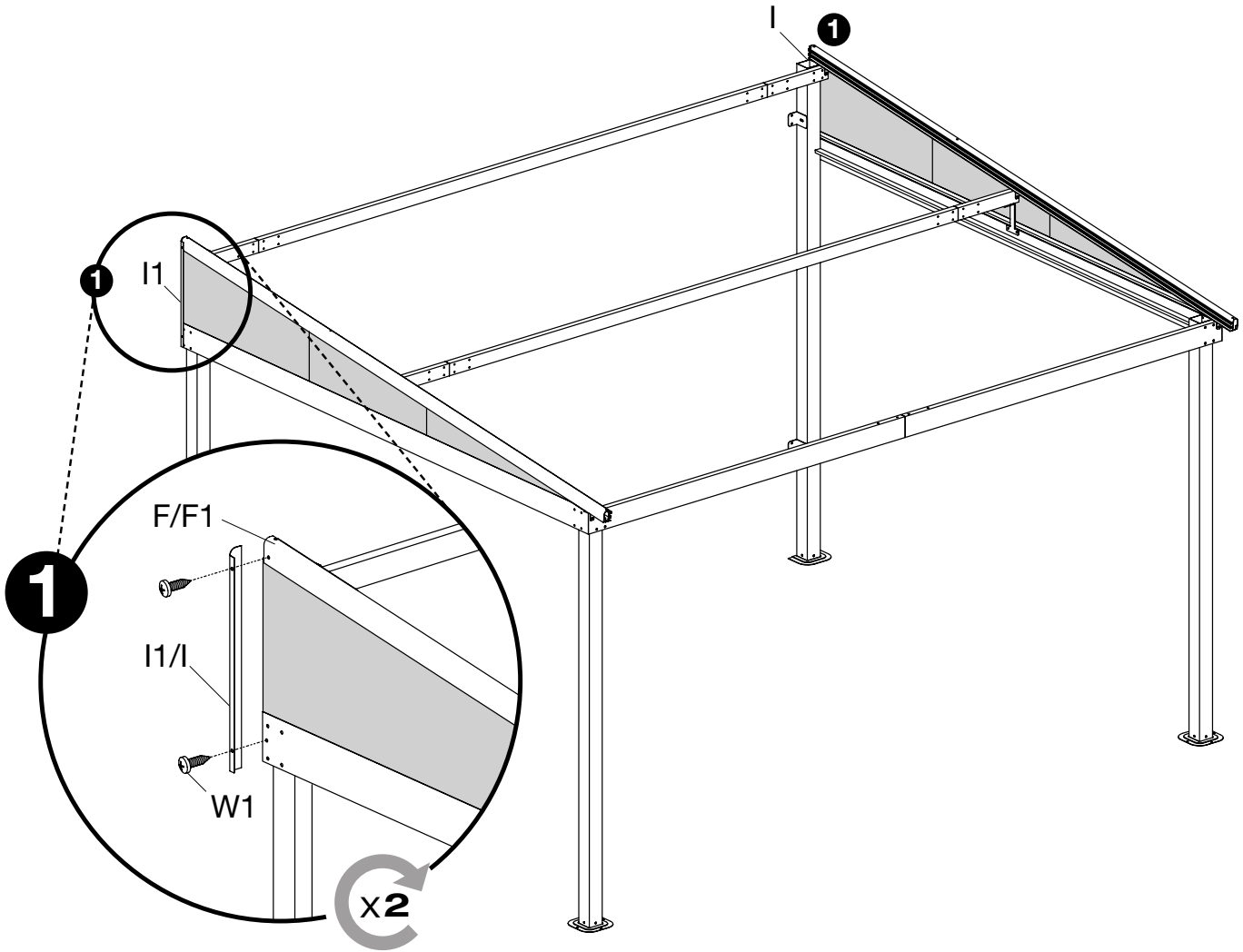

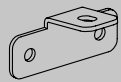
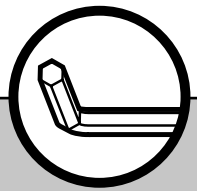
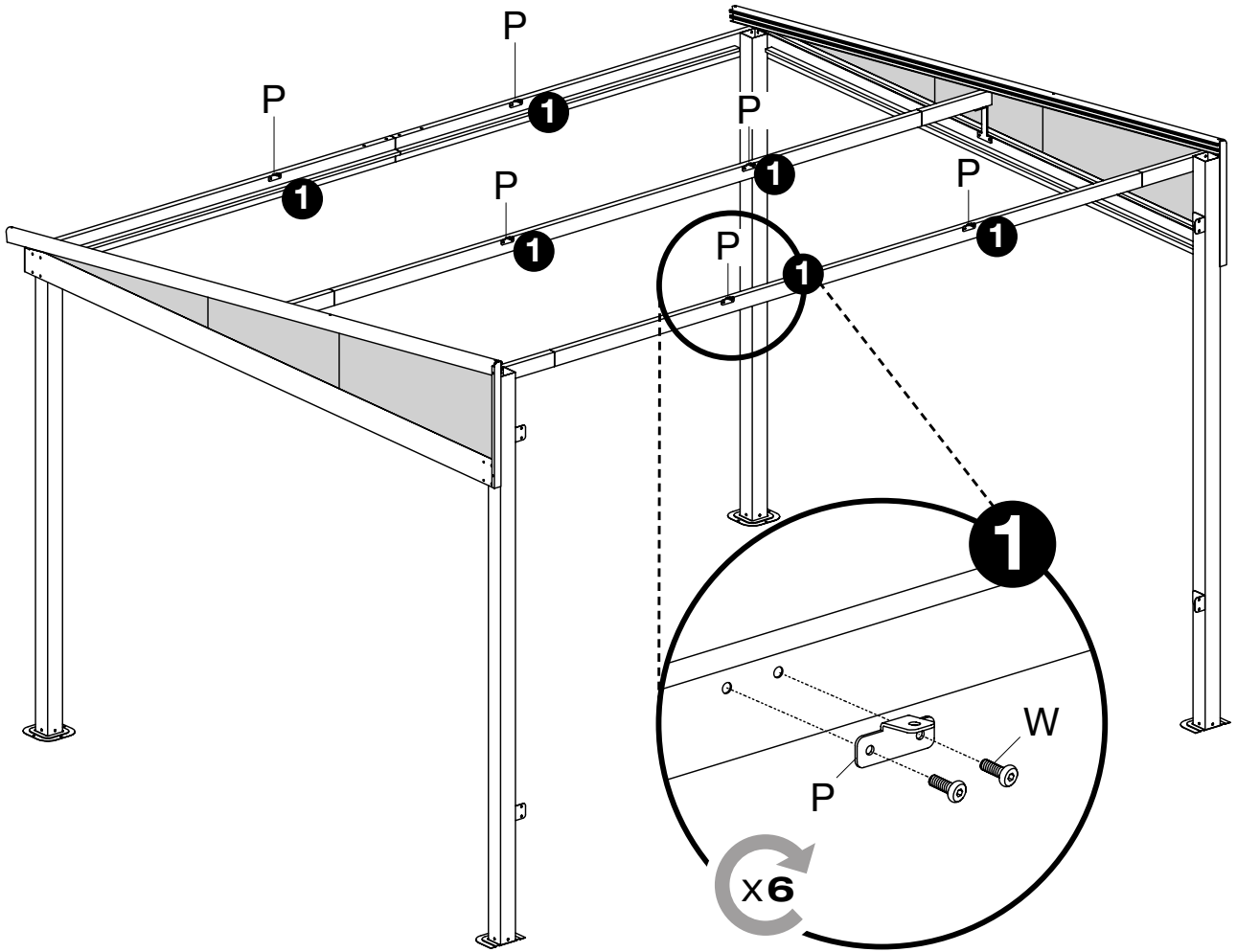

Px6

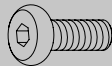

Wx12

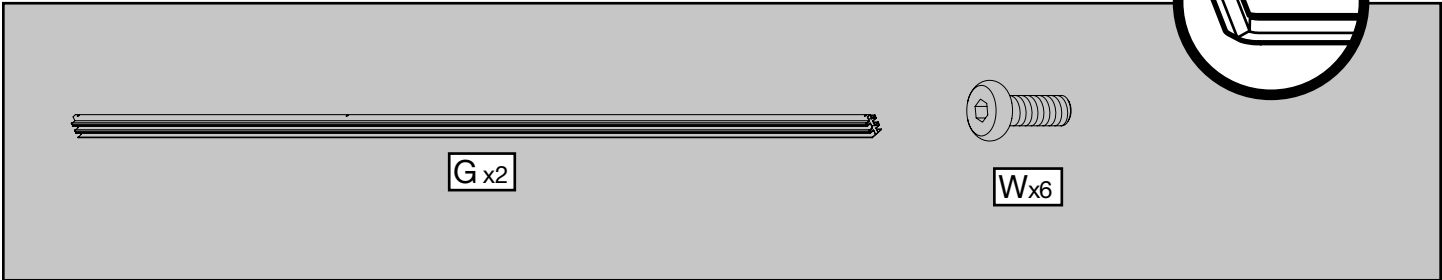
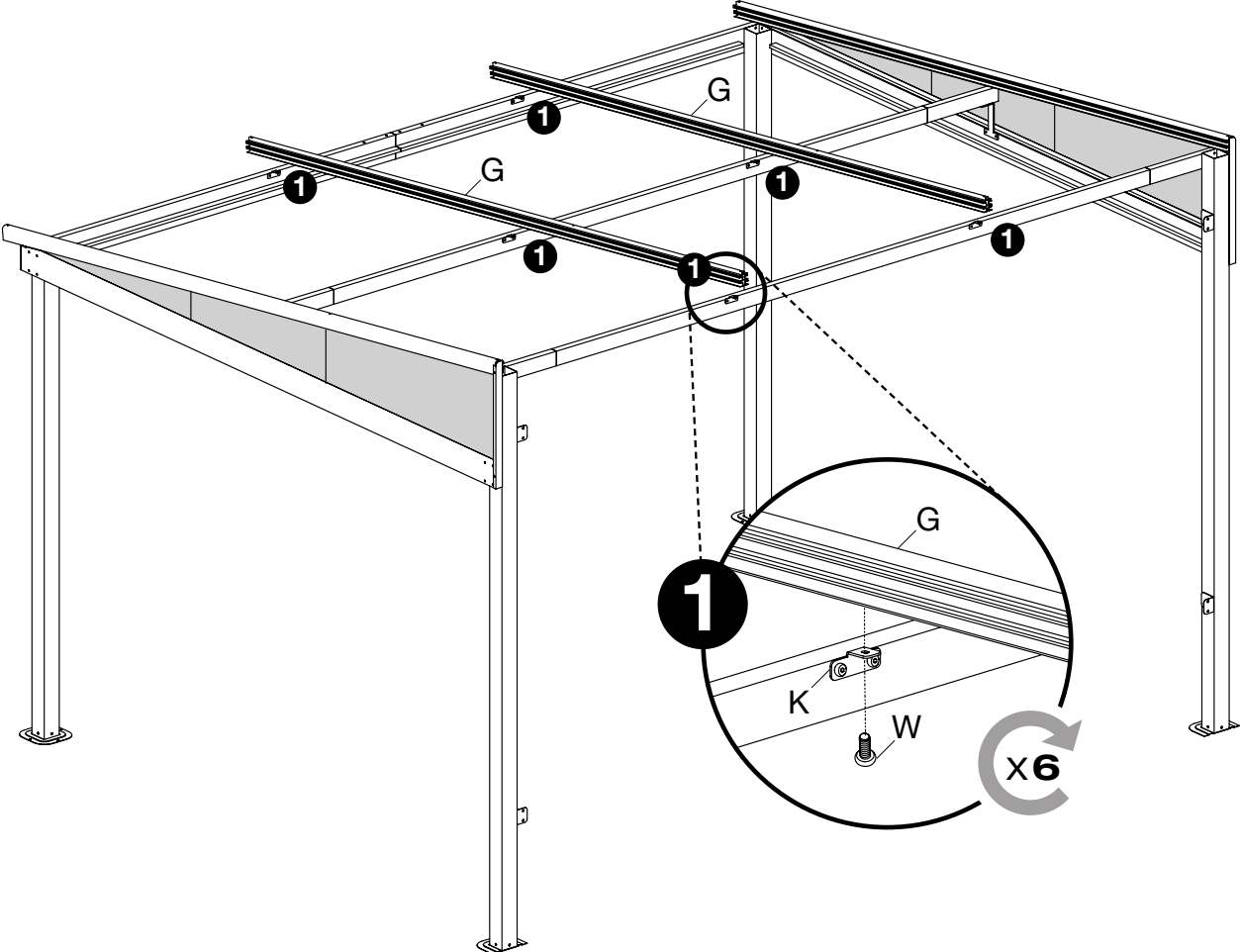

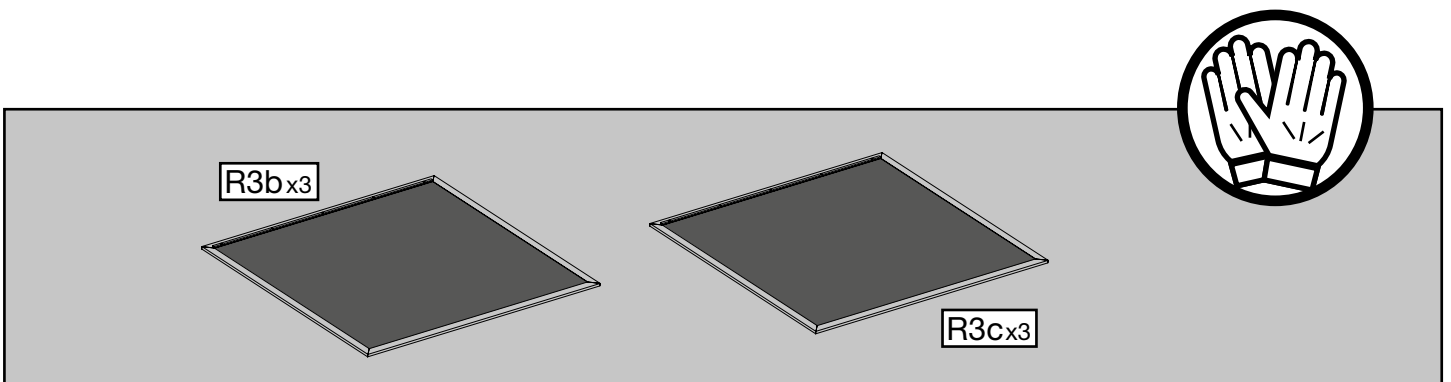
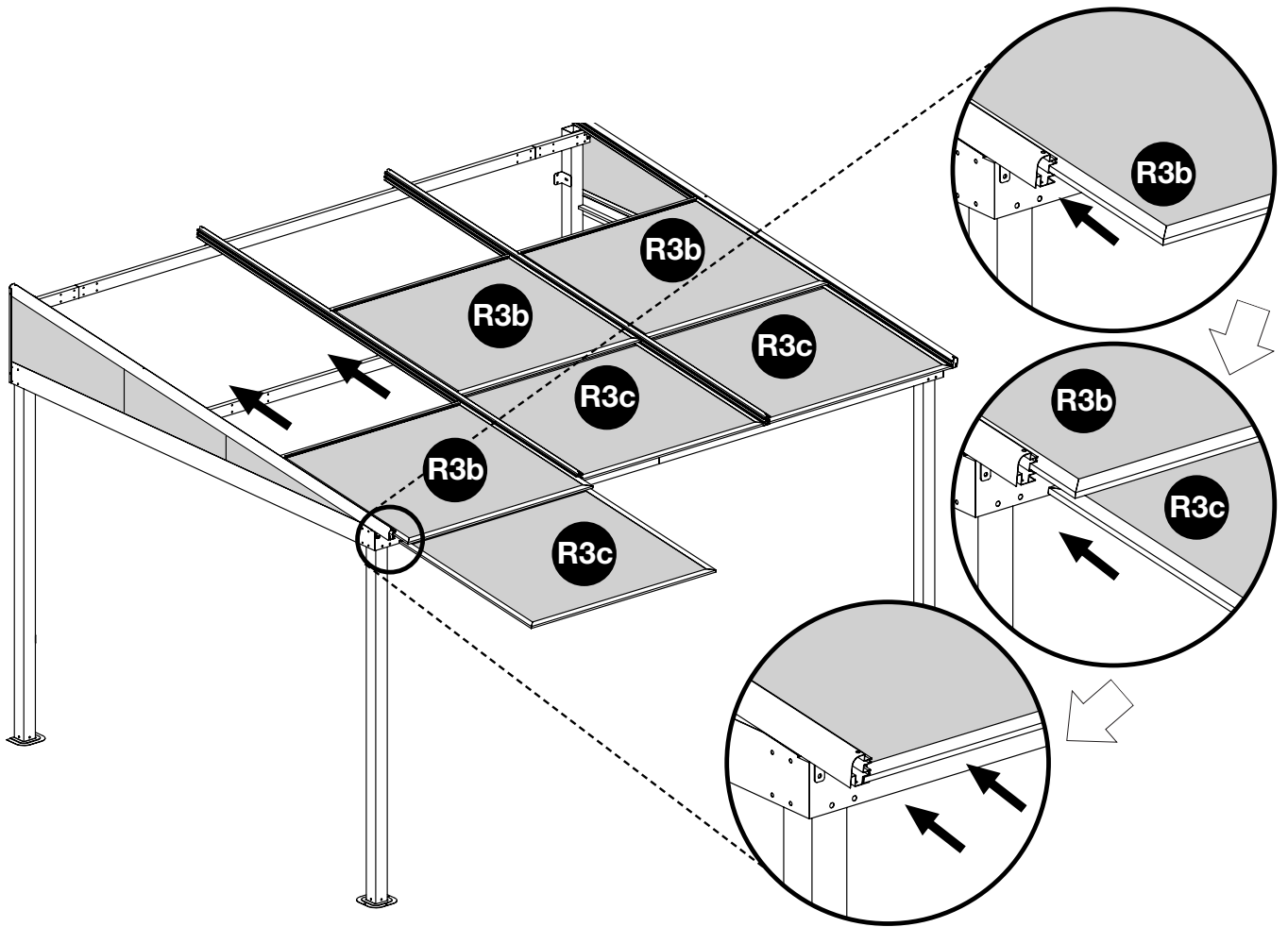

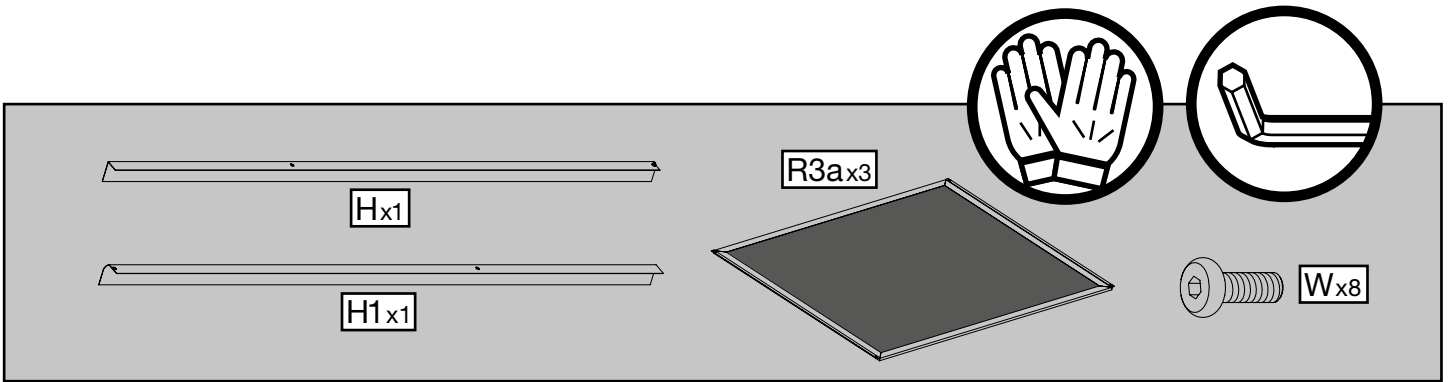
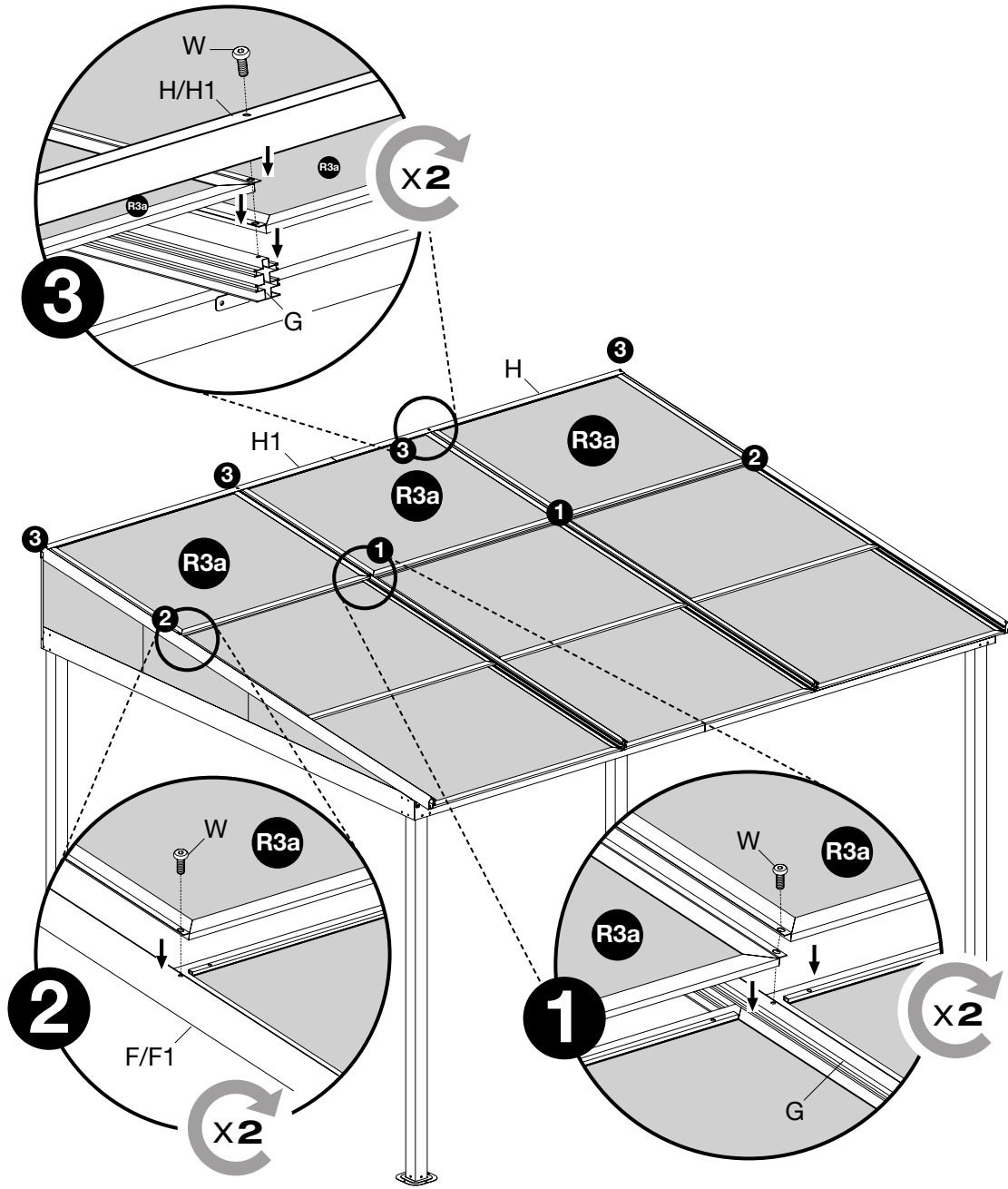

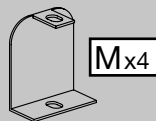
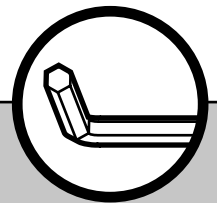
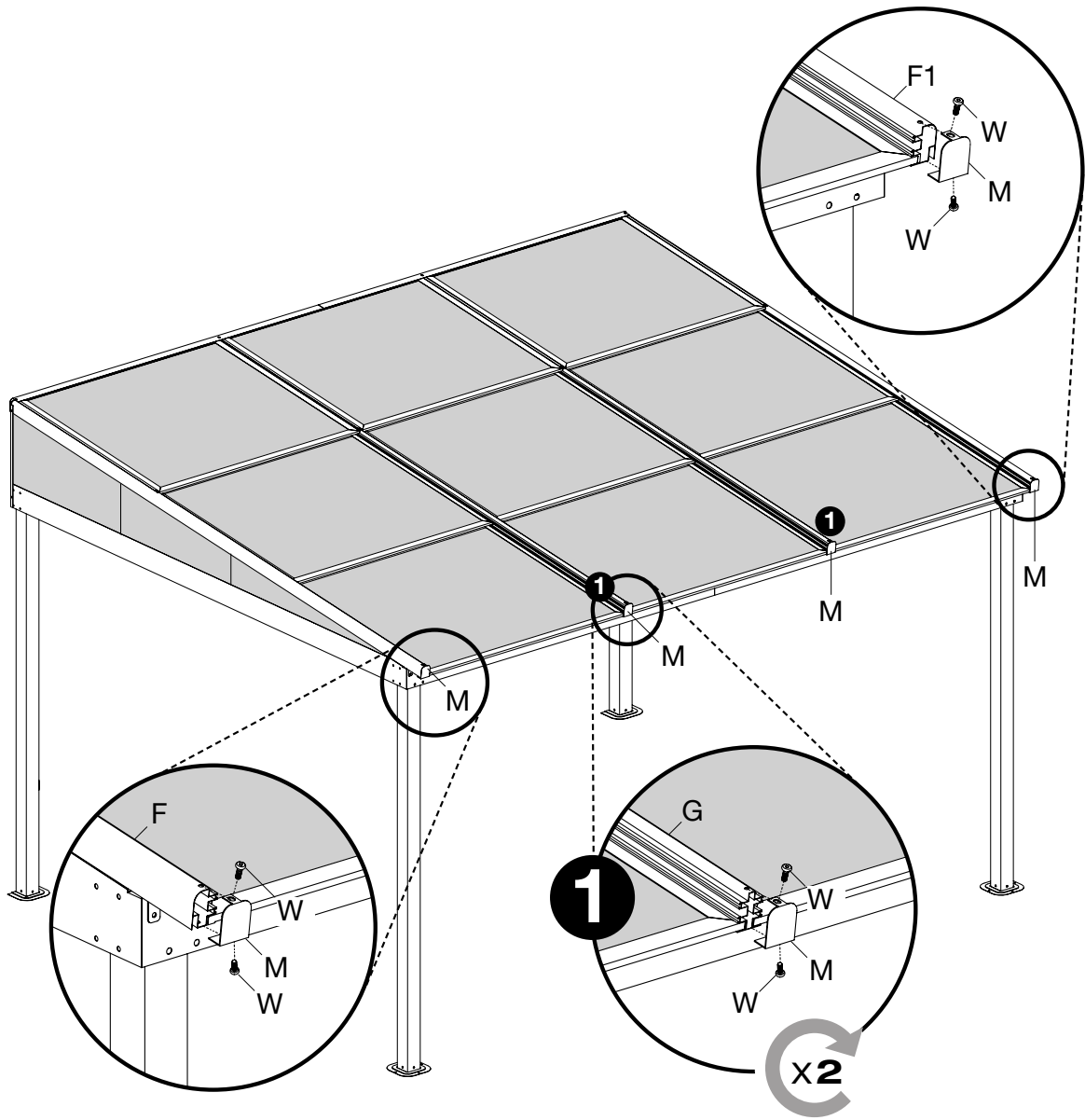

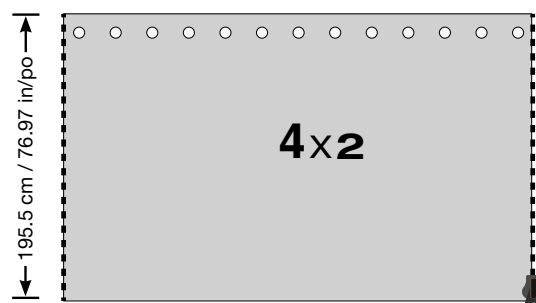
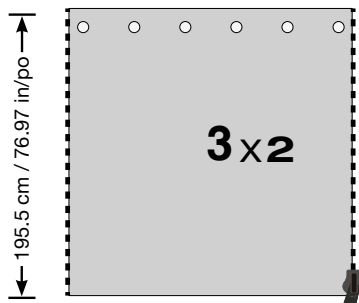
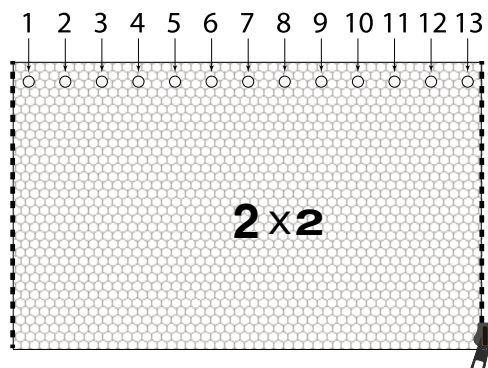
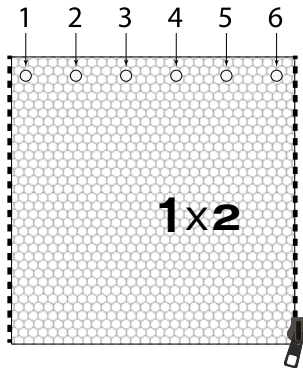
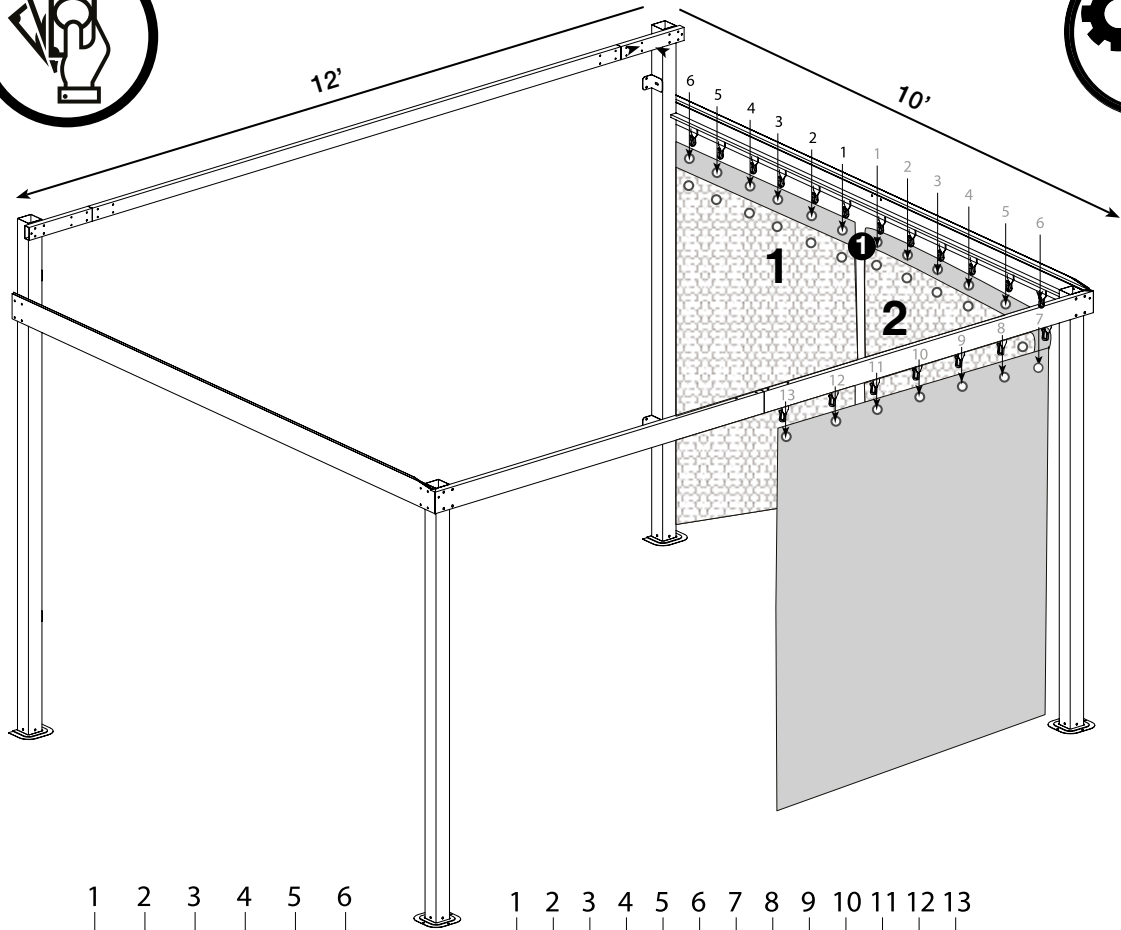
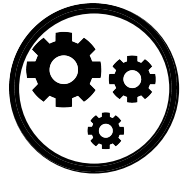

144 cm / 56.69 in

317 cm / 124.8 in



SOJAG ■ I

produits saisonniers • seasonal products