

<b>Selected Model</b>	
Model number	RGV3-305-N
<b>Exterior Appearance</b>	
Color Appearance	Stainless Steel
Design Style	Professional
Grates	Robust Cast-iron
<b>Features</b>	
Configuration	5 Burners
Energy type	Gas
Cooktop Burners	Sealed
Fuel Type	Natural Gas (NG)
Control Location	Upfront
Control Type	Titane plated Rotating-Knob Controls with Illuminated halo
Recommended rangehood	HCB30-6-N
<b>Capacity</b>	
Oven Capacity	4.6 pi <sup>3</sup>
<b>Cooktop Features</b>	
Ignition System	Electronic with automatic reignition
Cooktop Surface	Porcelain enamelled basepan
<b>Oven Features</b>	
Convection Technology	Traditional Convection
Oven Cleaning Type	Manual
Oven Modes	4
Broil Element	18500 BTU
Oven Rack	2 full extension telescopic racks
Shelves Positions	5
Oven door features	Cool Touch Triple Glazed Door
Bake element	21000 BTU
Beneath Oven Cavity	Heat dissipating grids
<b>Installation</b>	
Installation Type	Built-in (Flush with the Cabinets) or Free Standing
<b>Burner ratings</b>	
Flexible Burners	2X 18500 BTU
Burner Feature	Simmer performance (140°F) on all 4 burners (Performance may vary on LP models)
2 in 1 HP burners	1x 23500 BTU
	4 x 18500 BTU
Total BTU capacity	97500 BTU
<b>Exterior Dimensions</b>	
Overall Height (in.)	35 3/4"- 36 3/4"
Overall Width (in.)	29 7/8"
Overall Depth (in.)	29 1/8"
<b>Oven Rack Dimension</b>	
Depth (in.)	17 1/2"
<b>Electrical Requirements</b>	
Volts; Hertz; Amps	120V; 60Hz; 15 Amp
<b>Accessories (optional)</b>	
Optional backsplash	BGRV2-1230 (30", 12" x 30") BGRV2-3030 ( 30", 30" x 30") BGRV3-3030H (Bi-énergie,combustible PRO 30" x 30" (RDV3-RIV3-RGV3) AH-R30 (Pro SS 30" (1))
Square SS handle	
<b>Warranty</b>	
2 Years full warranty	Entire Appliance, In-Home Parts & Labour

# PRODUCT DIMENSIONS – 30" MODELS

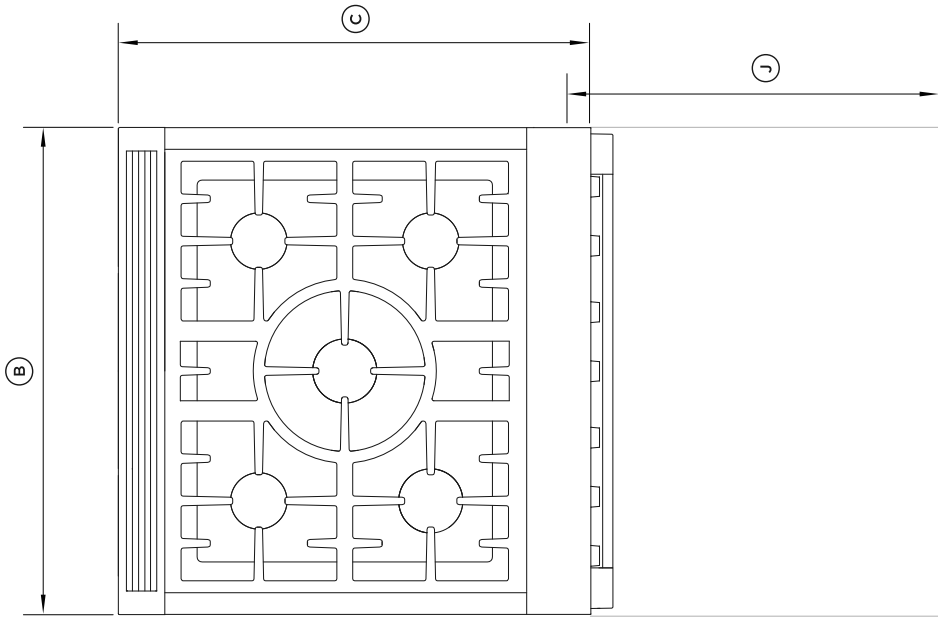

PLAN

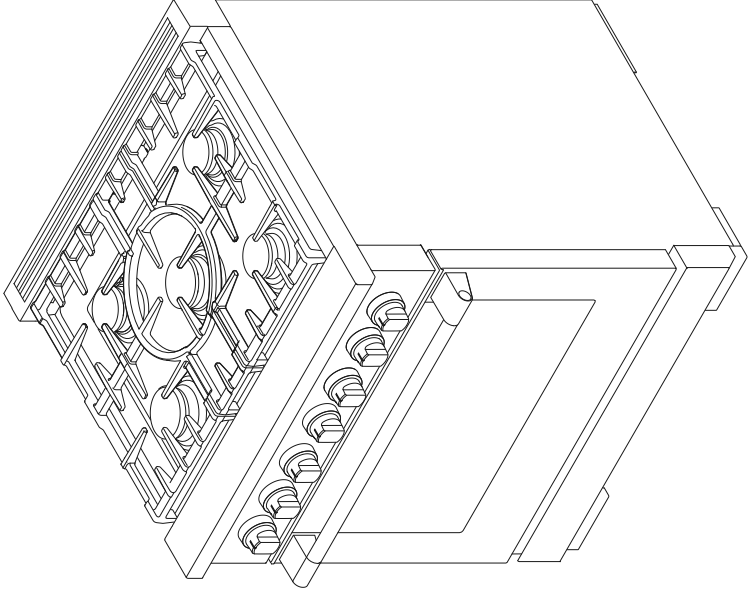

ISOMETRIC

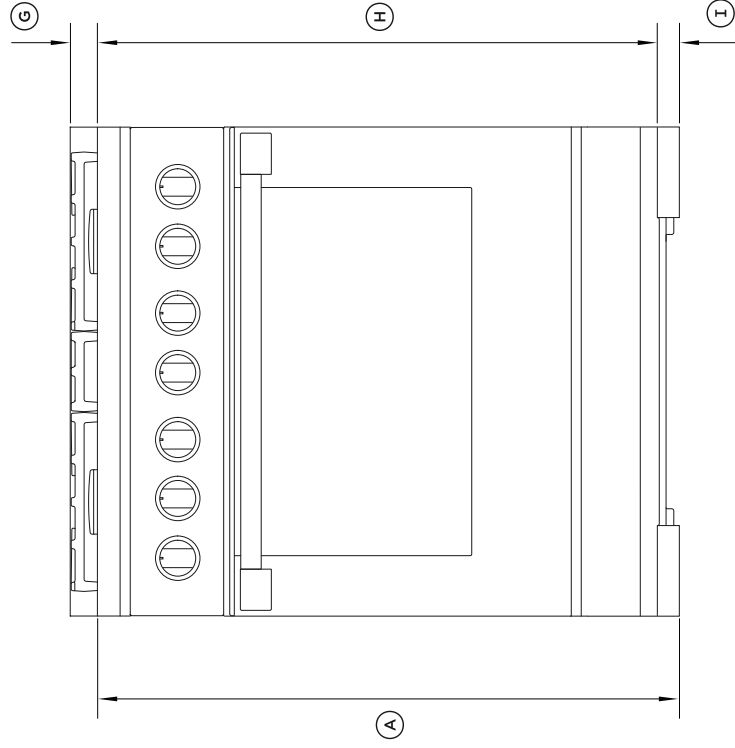

FRONT

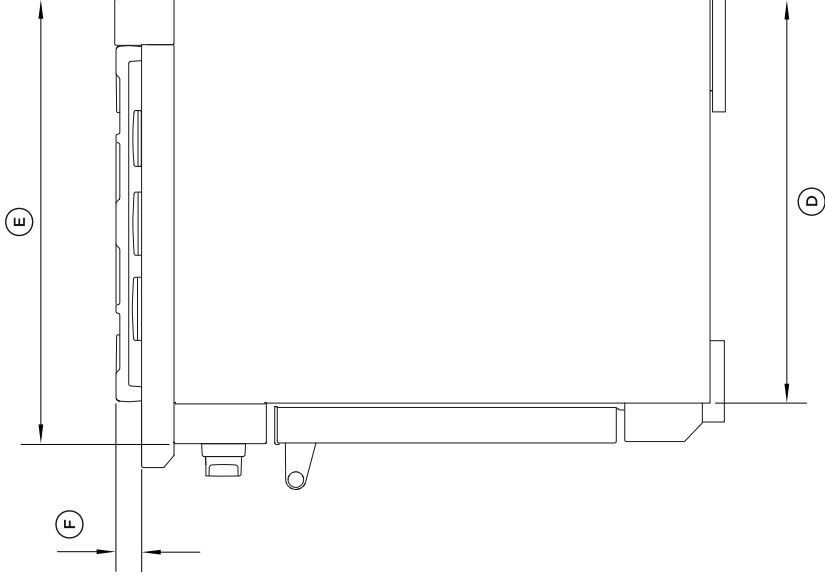

PROFILE

PRODUCT DIMENSIONS	30" MODELS	
	IN	MM
<b>(A)</b> Overall height* <ul style="list-style-type: none"> <li>• Min. (legs fully retracted) 35 3/4 908</li> <li>• Max. (legs fully extended) 36 3/4 933</li> </ul>		
<b>(B)</b> Overall width	29 7/8	759
<b>(C)</b> Overall depth	29 1/8	740
<b>(D)</b> Depth of chassis	25 3/8	644
<b>(E)</b> Depth from rear to control panel front	27 11/16	703
<b>(F)</b> Height from cook surface to top of burners	1 9/16	40
<b>(G)</b> Height from cook surface to top of trim <ul style="list-style-type: none"> <li>• Vent Trim 1 3/4 45</li> <li>• Angled Vent Trim*** 3 1/2 90</li> </ul>		
<b>(H)</b> Height from cook surface to chassis base	35 1/4	895
<b>(I)</b> Height of adjustable feet <ul style="list-style-type: none"> <li>• Min. (legs fully retracted) 1/2 13</li> <li>• Max. (legs fully extended) 1 1/2 38</li> </ul>		
<b>(J)</b> Depth of open door to front control panel	19 1/8	486

\*excluding burners and trim  
 \*\*excluding handle and dials  
 \*\*\*purchased separately

## PRODUCT WEIGHT

	30" MODELS	
	LB	KG
Overall weight (excluding packaging)	408	185

RGV3 305 model illustrated  
 Dimensions may vary by ± 2mm

# PRODUCT DIMENSIONS – 36" MODELS

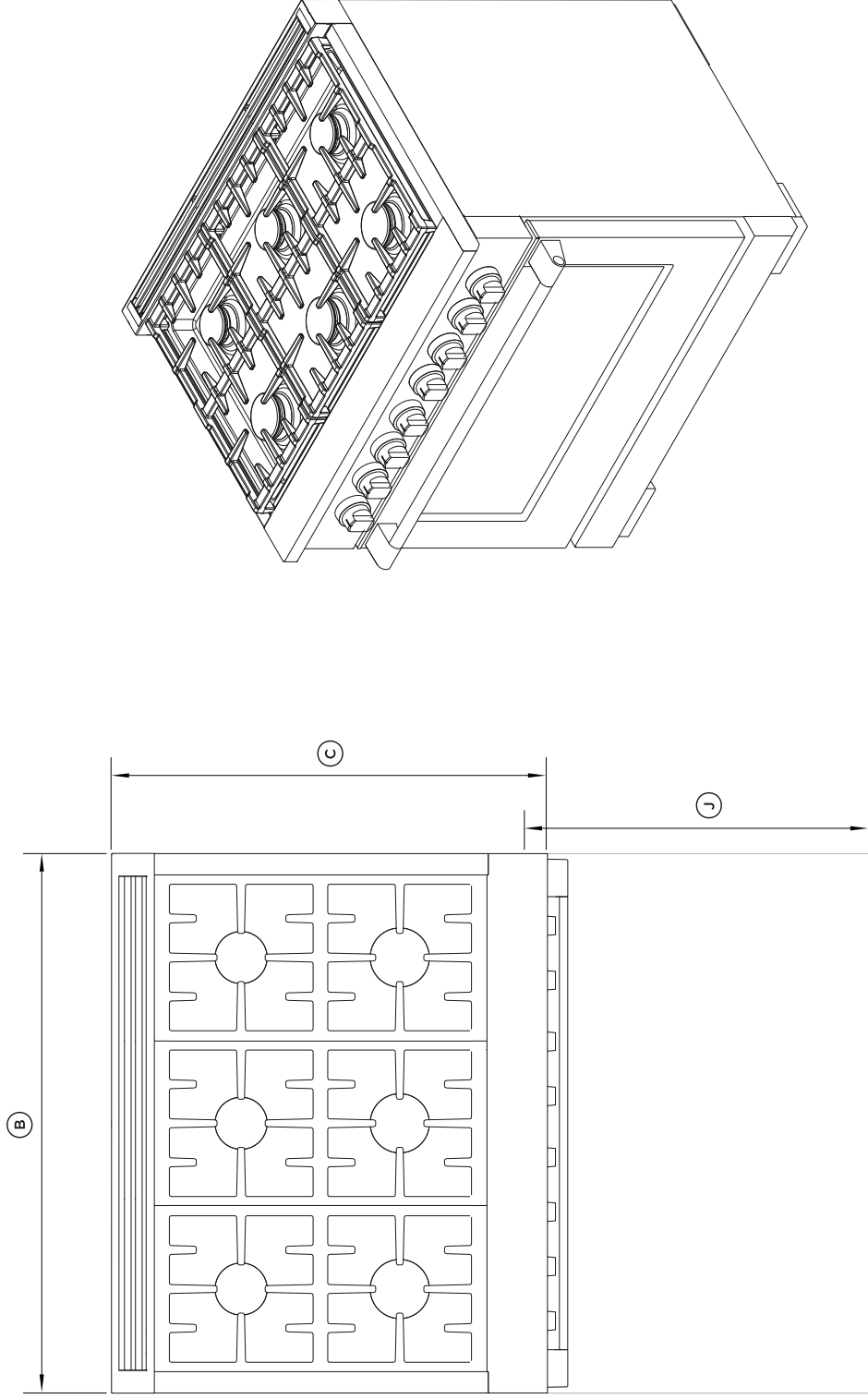

PLAN

ISOMETRIC

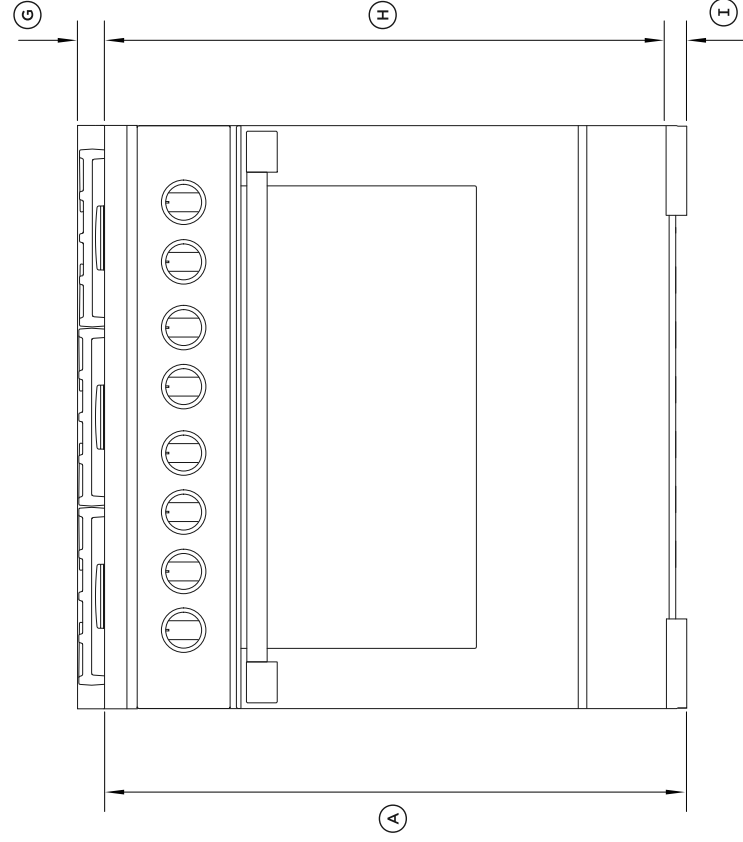

FRONT

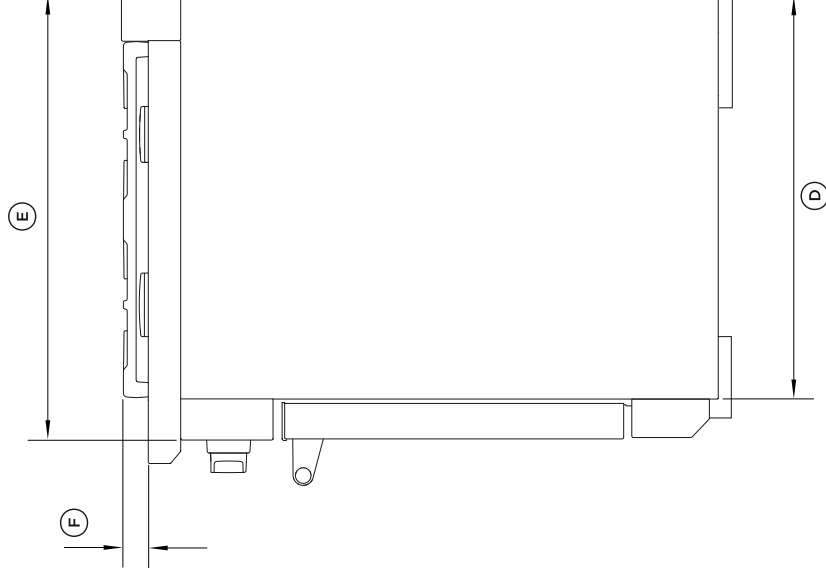

PROFILE

PRODUCT DIMENSIONS	36" MODELS	
	IN	MM
Ⓐ Overall height*		
• Min. (legs fully retracted)	35 3/4	908
• Max. (legs fully extended)	36 3/4	933
Ⓑ Overall width	35 7/8	911
Ⓒ Overall depth	29 1/8	740
Ⓓ Depth of chassis	25 3/8	644
Ⓔ Depth from rear to control panel front	27 11/16	703
Ⓕ Height from cook surface to top of burners	1 9/16	40
Ⓖ Height from cook surface to top of trim		
• Vent Trim	1 3/4	45
• Angled Vent Trim***	3 1/2	90
Ⓗ Height from cook surface to chassis base	35 1/4	895
Ⓘ Height of adjustable feet		
• Min. (legs fully retracted)	1/2	13
• Max. (legs fully extended)	1 1/2	38
Ⓙ Depth of open door to front control panel	19 1/8	486

\*excluding burners and trim  
 \*\*excluding handle and dials  
 \*\*\*purchased separately

## PRODUCT WEIGHT

36" MODELS	LB	KG
	Overall weight (excluding packaging)	440

# PRODUCT DIMENSIONS – 48" MODELS

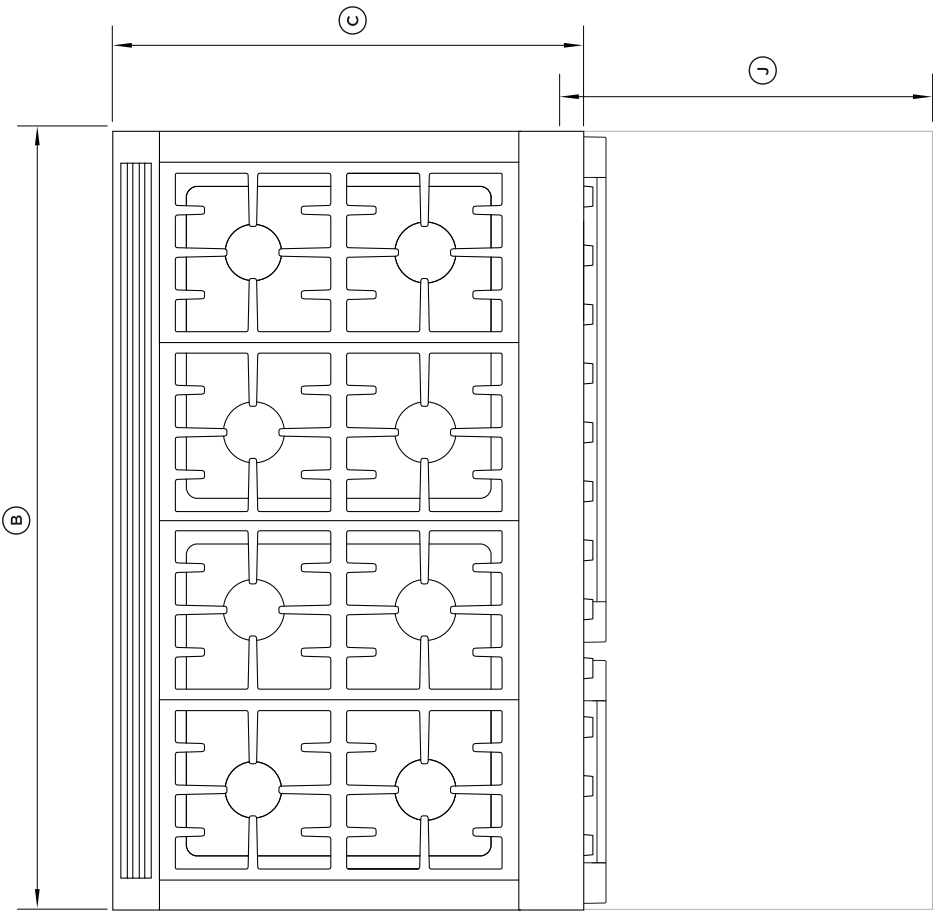

PLAN

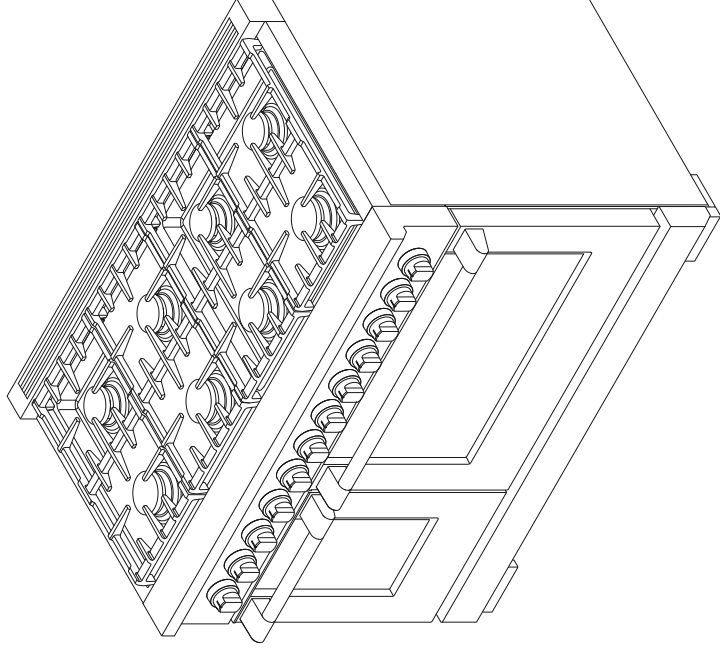

ISOMETRIC

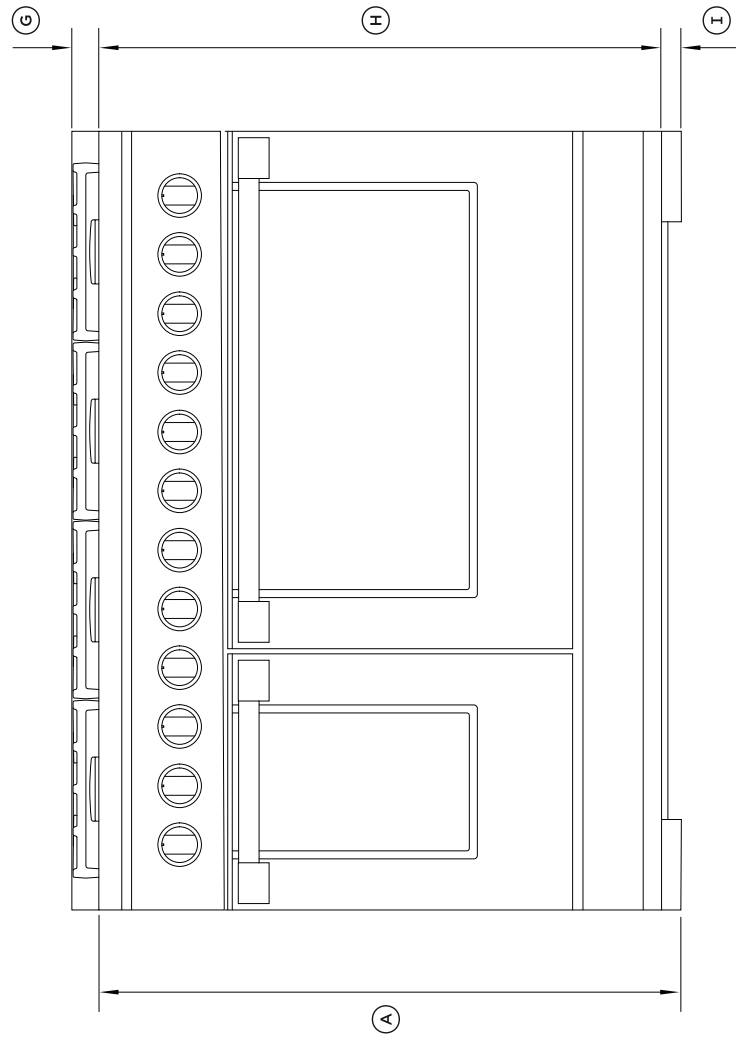

FRONT

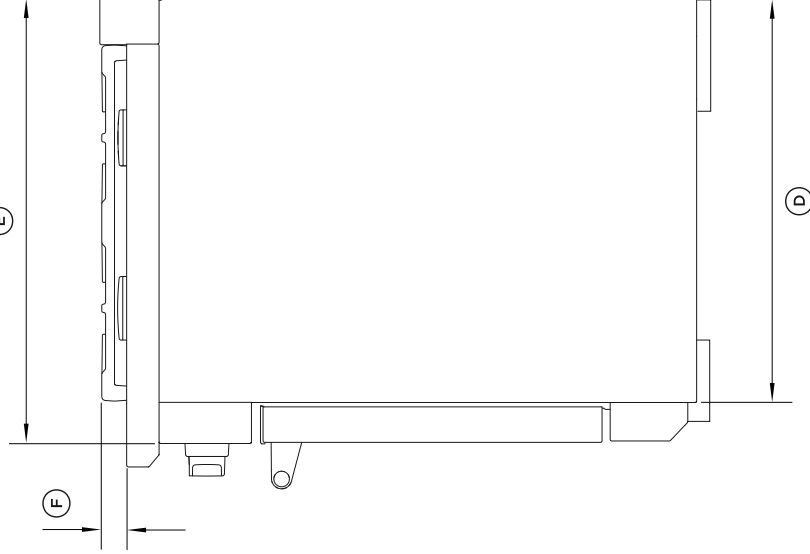

PROFILE

PRODUCT DIMENSIONS	48" MODELS	
	IN	MM
Ⓐ Overall height*		
• Min. (legs fully retracted)	35 3/4	908
• Max. (legs fully extended)	36 3/4	933
Ⓑ Overall width	47 7/8	1216
Ⓒ Overall depth	29 1/8	740
Ⓓ Depth of chassis	25 3/8	644
Ⓔ Depth from rear to control panel front	27 11/16	703
Ⓕ Height from cook surface to top of burners	1 9/16	40
Ⓖ Height from cook surface to top of trim		
• Vent Trim	1 3/4	45
• Angled Vent Trim***	3 1/2	90
Ⓗ Height from cook surface to chassis base	35 1/4	895
Ⓘ Height of adjustable feet		
• Min. (legs fully retracted)	1/2	13
• Max. (legs fully extended)	1 1/2	38
⓵ Depth of open door to front control panel	19 1/8	486

\*excluding burners and trim  
 \*\*excluding handle and dials  
 \*\*\*purchased separately

## PRODUCT WEIGHT

48" MODELS	LB	KG
	Overall weight (excluding packaging)	604 - 640

RGV3 488 model illustrated  
 Dimensions may vary by ± 2mm

## CABINETRY DIMENSIONS

### 30" CABINETRY

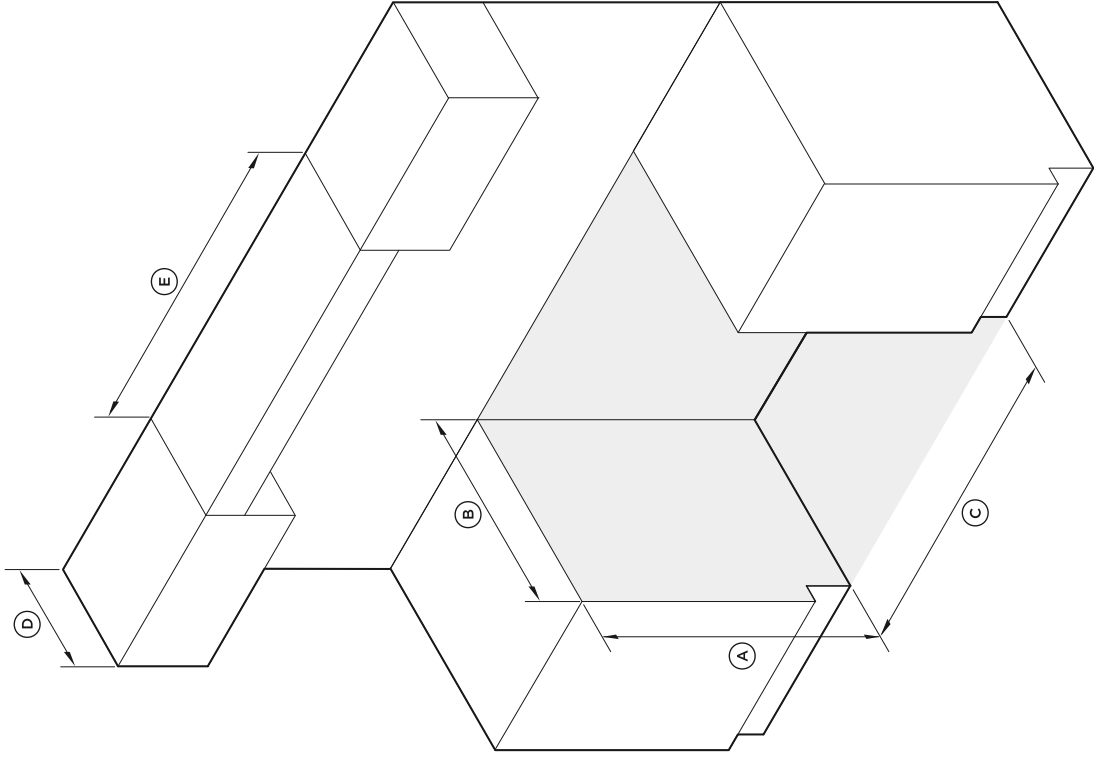

#### CABINETRY DIMENSIONS

#### 30" MODELS

	INCHES	MM
(A) Max. height		
• Flush with counter	35 3/4	908
• With levelling legs fully extended	36 3/4	933
(B) Depth		
• Flush with counter	27 11/16	703
• Projecting control panel	25 1/8	638
(C) Width	30	762
(D) Max. depth of overhead cabinetry	13	330
(E) Min. width of ventilation hood required	30	762

### 36" CABINETRY

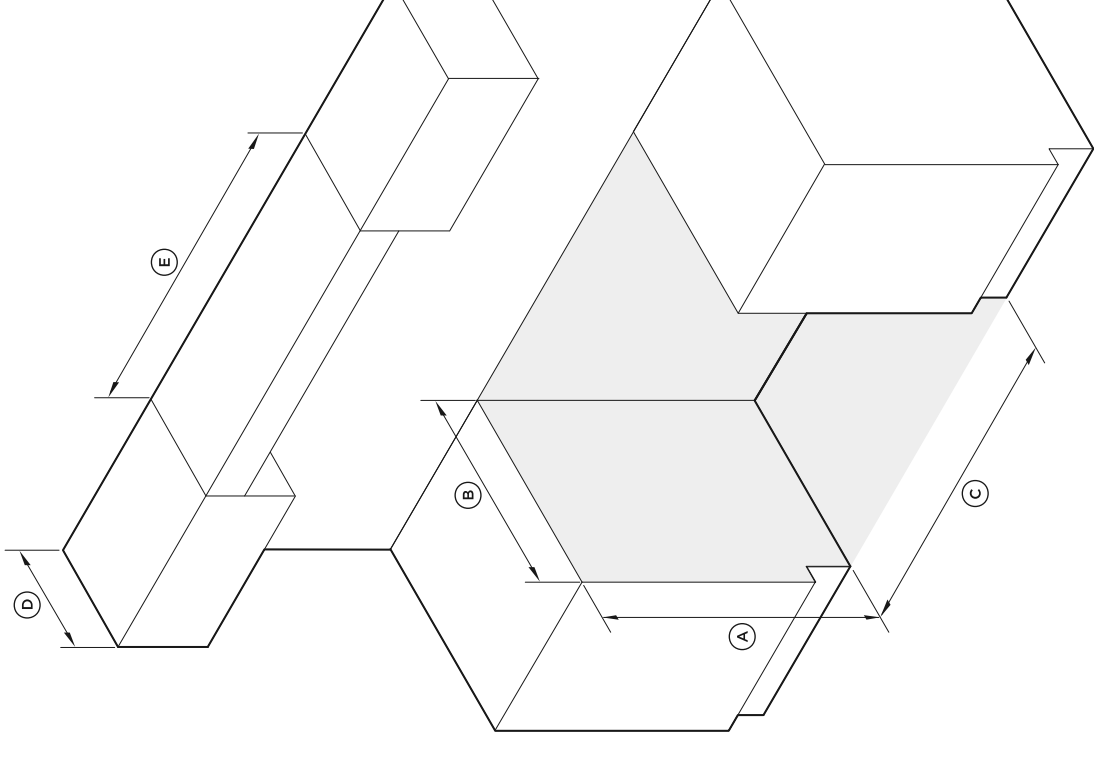

#### CABINETRY DIMENSIONS

#### 36" MODELS

	INCHES	MM
(A) Max. height		
• Flush with counter	35 3/4	908
• With levelling legs fully extended	36 3/4	933
(B) Depth		
• Flush with counter	27 11/16	703
• Projecting control panel	25 1/8	638
(C) Width	36	914
(D) Max. depth of overhead cabinetry	13	330
(E) Min. width of ventilation hood required	36	914

## CABINETS DIMENSIONS

### 48" CABINETS

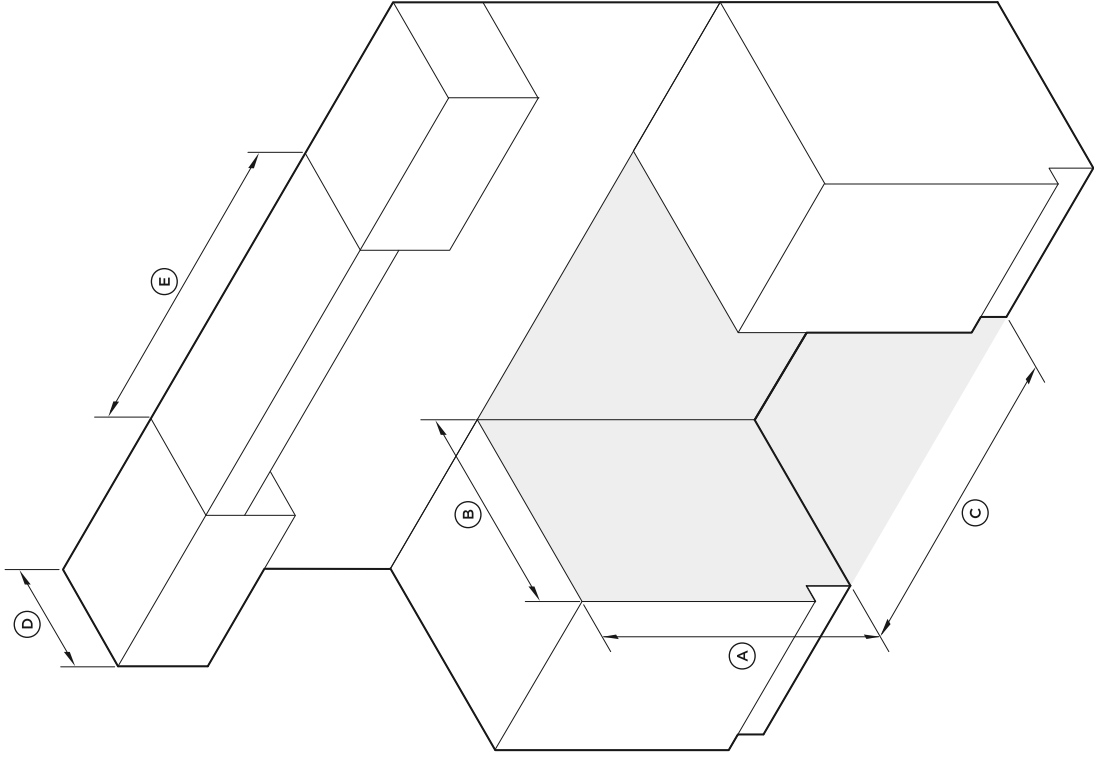

CABINETS DIMENSIONS	48" MODELS	
	INCHES	MM
(A) Max. height		
• Flush with counter	35 3/4	908
• With levelling legs fully extended	36 3/4	933
(B) Depth		
• Flush with counter	27 11/16	703
• Projecting control panel	25 1/8	638
(C) Width	48	1219
(D) Max. depth of overhead cabinets	13	330
(E) Min. width of ventilation hood required	48	1219

### CLEARANCES

The below clearances apply to both wall and island installations for all models.

Ensure the cook surface sits flush or above the adjacent countertop and any openings behind or under the range are sealed. Flow of combustion and ventilation air must not be obstructed.

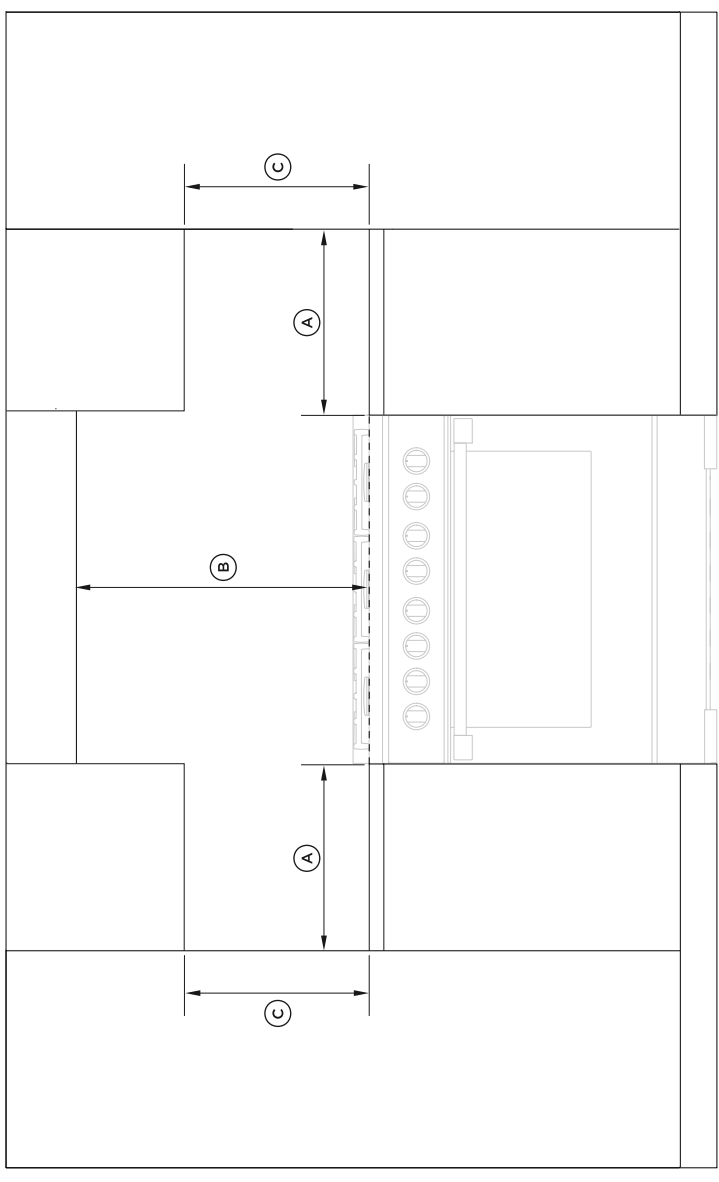

CLEARANCE DIMENSIONS	ALL MODELS	
	INCHES	MM
(A) Min. distance from side of range to nearest:		
• vertical combustible surface	12	305
(B) Min. distance from cook surface to overhead:		
• combustible surface	54	1372
• combustible covering for ventilation hood	36	914
• non-combustible surface	30	762
(C) Min. distance between countertop and cabinet	18	457

Non-combustible surfaces: as defined in 'National Fuel Gas Code' (ANSI Z223.1, Current Edition). Clearances from non-combustible materials are not part of the ANSI Z211 scope and are not certified by UL. Clearances of less than 6" (152mm) must be approved by the local codes and/or by the local authority having jurisdiction.

## VENTILATION REQUIREMENTS

- Ventilation hoods and blowers are designed for use with single wall ducting, however some local building codes or inspectors may require double wall ducting and/or a damper. Consult local building codes and/or agencies before installing to ensure local requirements are met.
- Hood blower speeds should be variable to reduce noise and loss of household air. The maximum speed should only be required when using the grill or **SELF CLEAN**.
- Due to a high volume of ventilation air, a source of make-up air (outside replacement air) is recommended. This is particularly important for tightly sealed and insulated homes. A reputable heating and ventilating contractor should be consulted.

### ..... WALL INSTALLATION .....

**Non-combustible**

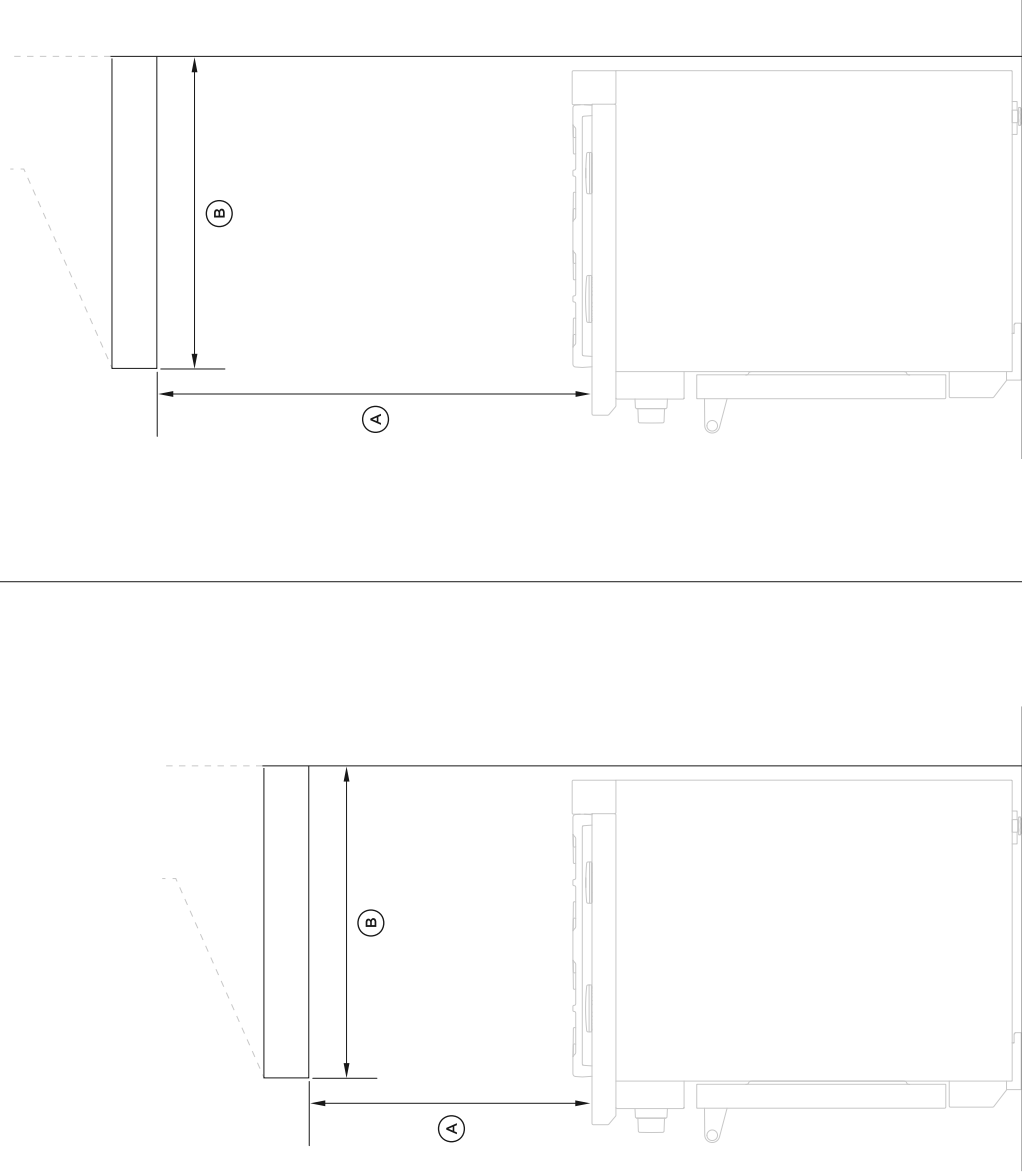

**Combustible**

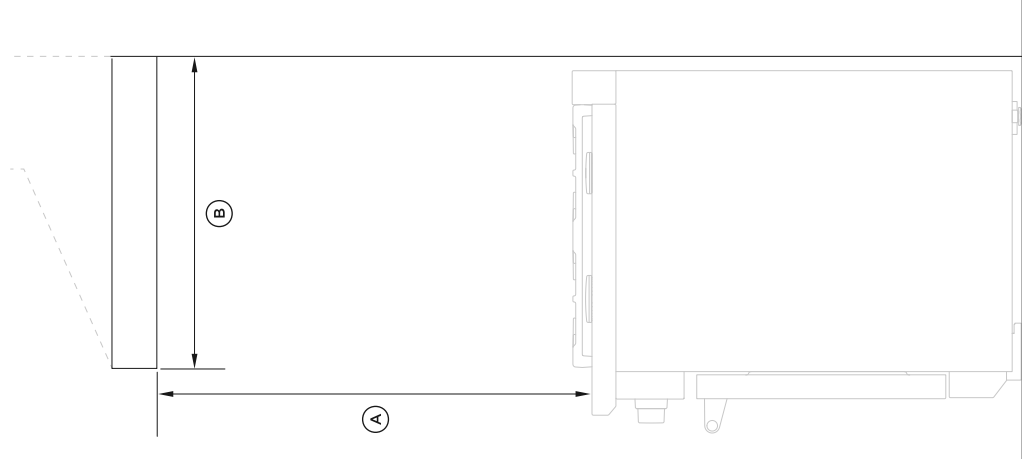

### ..... ISLAND INSTALLATION .....

**Non-combustible**

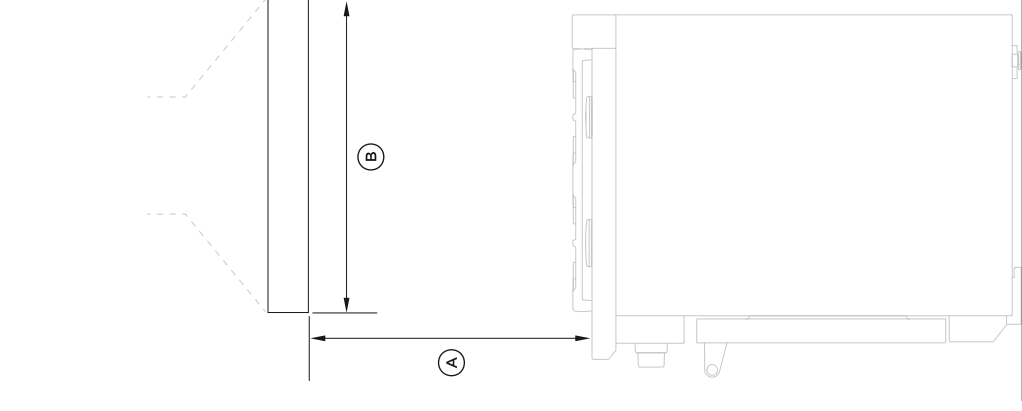

**Combustible**

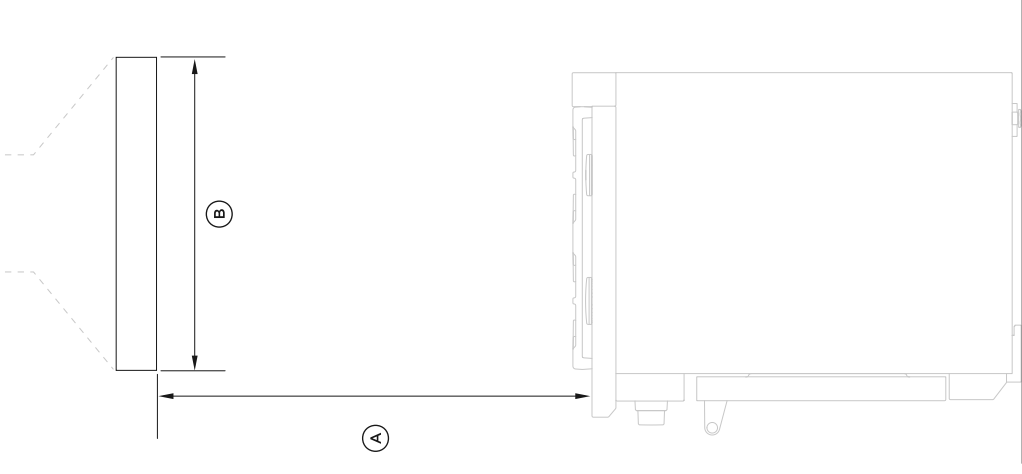

#### VENTILATION UNIT

#### WALL INSTALLATION RECOMMENDATIONS

<b>Hood</b>	(A)	min. 30" (762mm)	max. 42 (762mm)
	(B)	min. 19" (480mm)	max. 42 (762mm)
<b>Blower</b>	30" Range	min. 550 CFM	
	36" Range	min. 550 CFM	
	48" Range	min. 1100 CFM	

#### VENTILATION UNIT

#### ISLAND INSTALLATION RECOMMENDATIONS

<b>Hood</b>	(A)	min. 30" (762mm)	max. 42 (762mm)
	(B)	min. 19" (480mm)	max. 42 (762mm)
<b>Blower</b>	30" Range	min. 550 CFM	
	36" Range	min. 550 CFM	
	48" Range	min. 1100 CFM	

## BACKGUARD CONSIDERATIONS

### WALL SURFACE

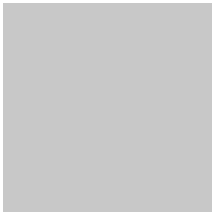

Non-combustible

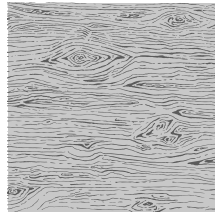

Combustible

### BACKGUARD OPTIONS

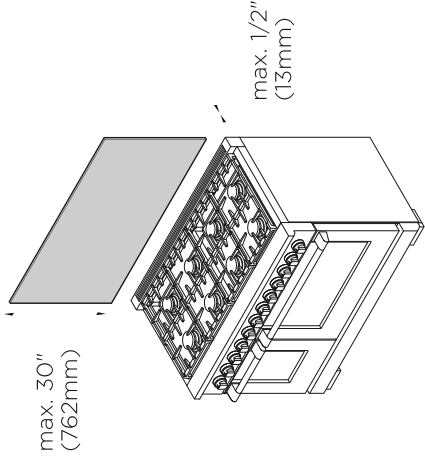

CUSTOM BACKGUARD  
made from non-combustible materials

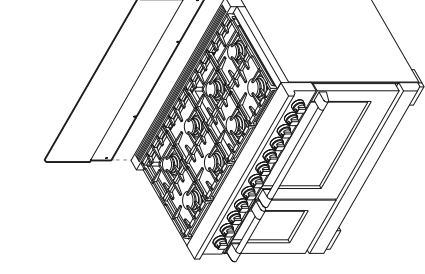

LOW THIN BACKGUARD

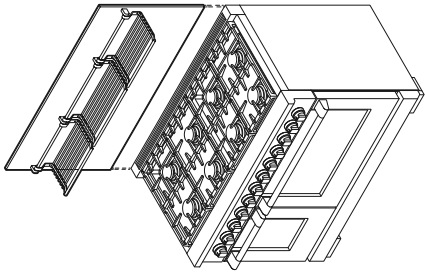

HIGH THIN BACKGUARD

NO BACKGUARD

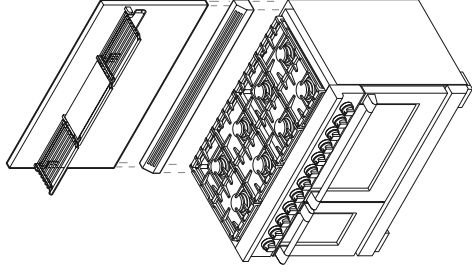

HIGH THICK BACKGUARD  
with angled trim

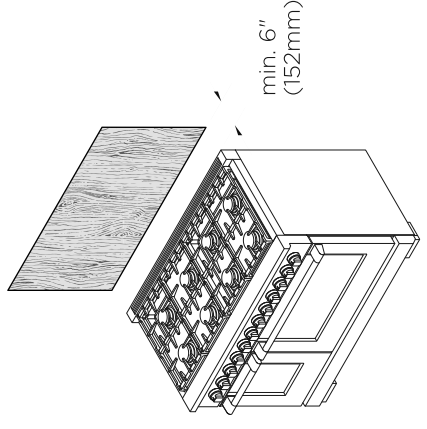

NO BACKGUARD

RANGE	RANGE MOUNT		WALL MOUNT		BACKGUARD WIDTH	
	LOW BACKGUARD	HIGH BACKGUARD	WALL MOUNT HIGH SHELF	HIGH BACKGUARD, LOW SHELF	INCHES	MM
30" models	BGRV2-1230		BGRV3-3030H	BGRV2-3030	29 7/8	759
36" models	BGRV2-1236		BGRV3-3036H	BGRV2-3036	35 7/8	911
48" models	BGRV2-1248		BGRV3-3048H	BGRV2-3048	47 7/8	1216

- **Installations against non-combustible surfaces:** you may install the range without a backguard or choose any of the three backguards.
- **Installations close to combustible surfaces (above the cooking surface):** without a backguard, there must be a min. 6" (152mm) clearance.
- **Installations immediately against combustible surfaces (above the cooking surface):** you must purchase and fit the Wall Mount High Backguard High Shelf and Angled Vent Trim.
- **Non-combustible surfaces:** as defined in 'National Fuel Gas Code' (ANSI Z223.1, Current Edition). Clearances from non-combustible materials are not part of the ANSI Z21.1 scope and are not certified by UL. Clearances of less than 6" (152mm) must be approved by the local codes and/or by the local authority having jurisdiction.

Note: Backguards can be purchased separately. All ranges come fitted with an Integral Vent Trim only.  
For more information on Backguard installation, refer to the separate instructions provided with your backguard. Backguard Installation Instructions can also be downloaded from our website, [www.fisherpaykel.com](http://www.fisherpaykel.com)