



**INSTRUCTIONS D'ASSEMBLAGE**  
**ASSEMBLY INSTRUCTIONS**

---

**M**ONARCH  
SPECIALTIES INC.

# I 7301

---

**CHAISE DE BUREAU -**  
**BLANC / TISSU GRIS / DOSSIER EXECUTIF**

**OFFICE CHAIR -**  
**WHITE / GREY FABRIC / HIGH BACK EXECUTIVE**







**POUR DE L'ASSISTANCE OU POUR COMMANDER**  
**DES PIÈCES CONTACTEZ NOTRE DÉPARTEMENT**  
**DE SERVICE À LA CLIENTÈLE.**



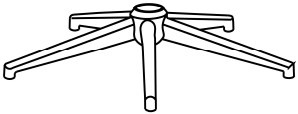

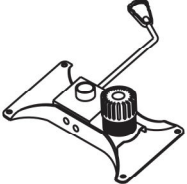
**FOR ASSISTANCE OR TO ORDER PARTS**  
**CONTACT OUR CUSTOMER SERVICE DEPARTMENT**

**WWW.MONARCHSERVICE.COM**

**LISTE DES PIÈCES**  
**PARTS LIST**

PIÈCE / PART #	IMAGE	DESCRIPTION	QTY / QTÉ
1		<p><b>CASTOR</b>  <b>ROULLETTE</b></p>	5
2		<p><b>BASE</b>  <b>BASE</b></p>	1
3		<p><b>GASLIFT</b>  <b>ASCENSEUR À ESSENCE</b></p>	1
4		<p><b>CHAIR MECHANISM SEAT PLATE</b>  <b>MÉCANISME DE SIÈGE</b></p>	1
5		<p><b>BACK REST</b>  <b>DOSSIER</b></p>	1

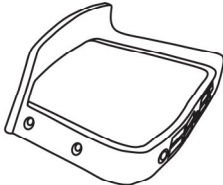
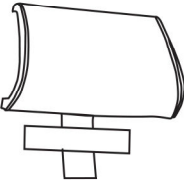
**LISTE DES PIÈCES**  
**PARTS LIST**

PIÈCE / PART #	IMAGE	DESCRIPTION	QTY / QTÉ
6		SEAT CUSHION COUSSIN DU SIÈGE	1
7		FRONT FACING LEFT ARMREST ACCOUDOIR AVANT GAUCHE	1
8		FRONT FACING RIGHT ARMREST ACCOUDOIR AVANT DROIT	1
9		HEADREST APPUI TÊTE	1
10		SCREW CAP CAPUCHON DE VIS	1

**LISTE DES PIÈCES**  
**PARTS LIST**

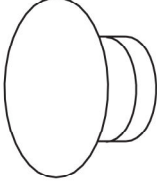
PIÈCE / PART #	IMAGE	DESCRIPTION	QTY / QTÉ
11		SCREW CAP CAPUCHON DE VIS	4

**LISTE DES PIÈCES DE MONTAGE**  
**HARDWARE LIST**

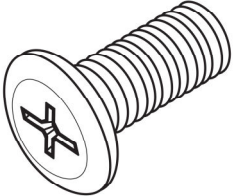
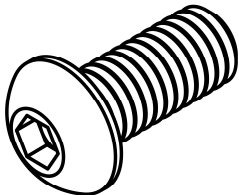
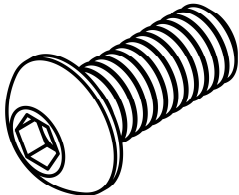
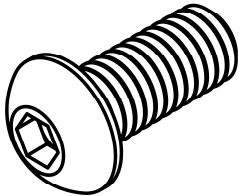
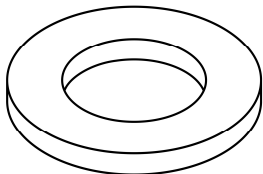
PIÈCE / PART #	IMAGE	DESCRIPTION	QTY / QTÉ
<b>A</b>		<b>ASSEMBLING BOLT -</b> <b>Ø 1/4" X 1 1/4"</b>  <b>BOULON D'ASSEMBLAGE -</b> <b>Ø 1/4" X 1 1/4"</b>	<b>2</b>
<b>B</b>		<b>ASSEMBLING BOLT -</b> <b>Ø 1/4" X 3/4"</b>  <b>BOULON D'ASSEMBLAGE -</b> <b>Ø 1/4" X 3/4"</b>	<b>4</b>
<b>C</b>		<b>ASSEMBLING BOLT -</b> <b>Ø 1/4" X 1 1/4"</b>  <b>BOULON D'ASSEMBLAGE -</b> <b>Ø 1/4" X 1 1/4"</b>	<b>6</b>
<b>D</b>		<b>ASSEMBLING BOLT -</b> <b>Ø 1/4" X 3/4"</b>  <b>BOULON D'ASSEMBLAGE -</b> <b>Ø 1/4" X 3/4"</b>	<b>4</b>
<b>E</b>		<b>METAL WASHER -</b> <b>Ø 5/8" X 1/4"</b>  <b>RONDELLE DE MÉTAL -</b> <b>Ø 5/8" X 1/4"</b>	<b>6</b>

**LISTE DES PIÈCES DE MONTAGE**  
**HARDWARE LIST**

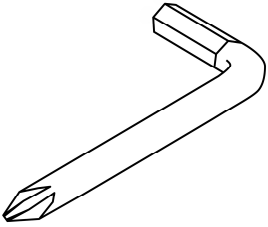
PIÈCE / PART #	IMAGE	DESCRIPTION	QTY / QTÉ
F		HEX KEY CLÉ HEXAGONALE	1

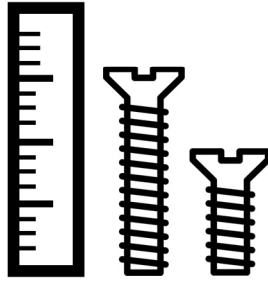

OUTIL DE VÉRIFICATION DE DIMENSIONS DES PIÈCES  
HARDWARE DIMENSIONS VERIFICATION TOOL

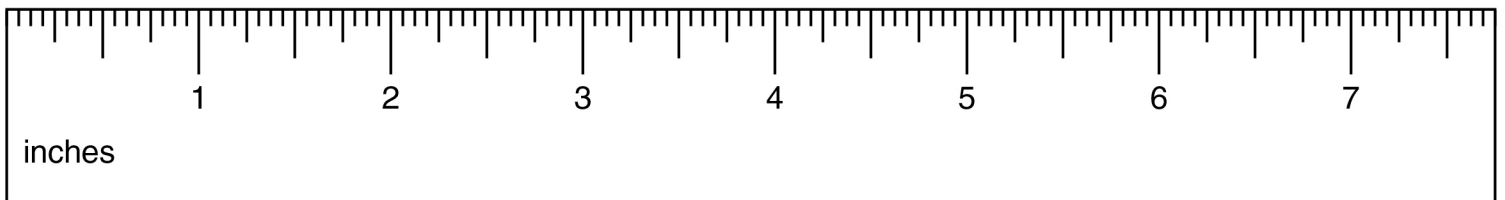

ÉTAPE / STEP 1

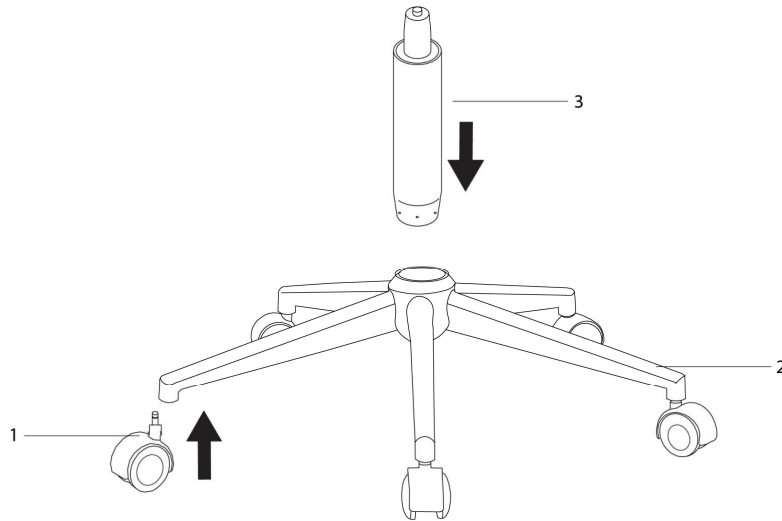

ÉTAPE / STEP 2

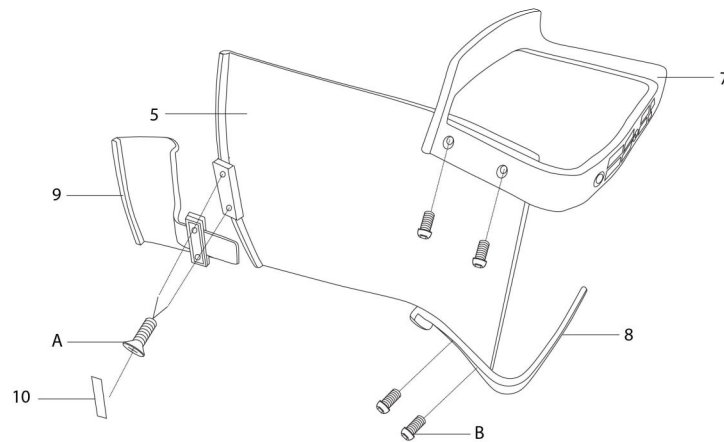



ÉTAPE / STEP 3

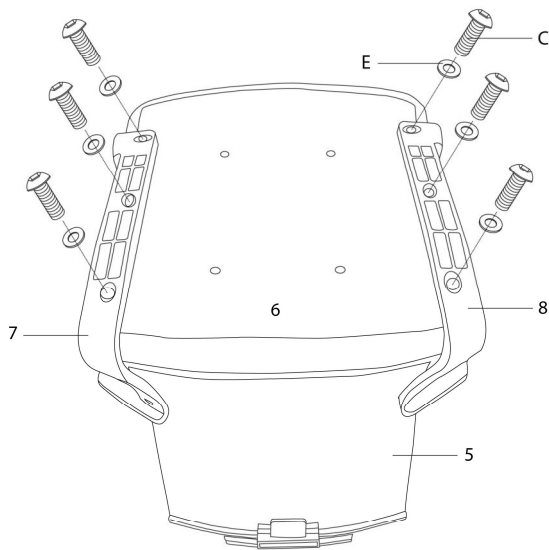

ÉTAPE / STEP 4

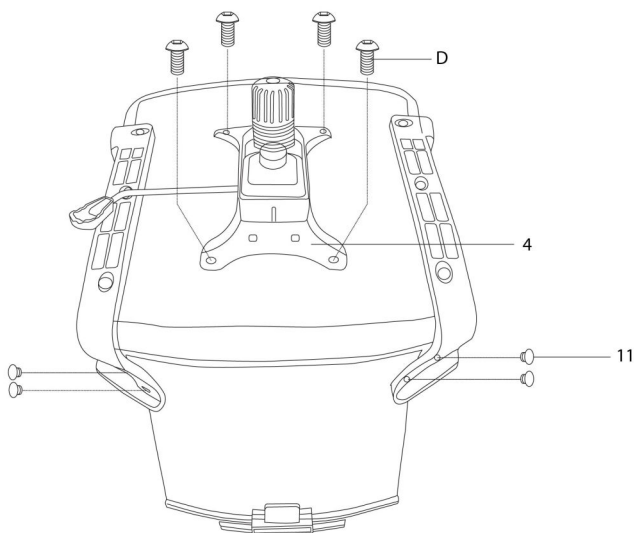

**ÉTAPE / STEP 5**

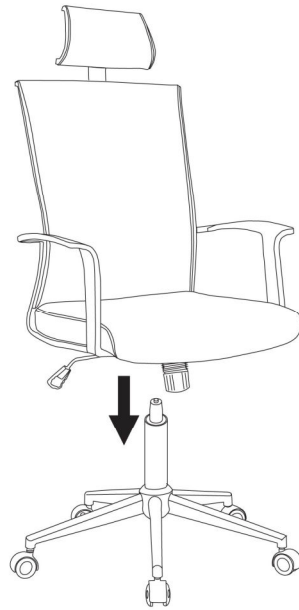

ÉTAPE / STEP 6

