



**INSTRUCTIONS D'ASSEMBLAGE
ASSEMBLY INSTRUCTIONS**

MONARCH
SPECIALTIES INC.

I 7390

**BUREAU -
58"L / DESSUS ESPRESSO DE COIN / METAL NOIR**

**COMPUTER DESK -
58"L / ESPRESSO TOP / BLACK METAL CORNER**



**POUR DE L'ASSISTANCE OU POUR COMMANDER
DES PIÈCES CONTACTEZ NOTRE DÉPARTEMENT
DE SERVICE À LA CLIENTÈLE.**

**FOR ASSISTANCE OR TO ORDER PARTS
CONTACT OUR CUSTOMER SERVICE DEPARTMENT**

WWW.MONARCHSERVICE.COM

LISTE DES PIÈCES
PARTS LIST

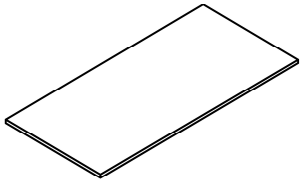
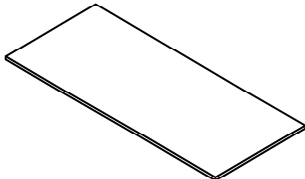
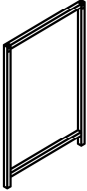
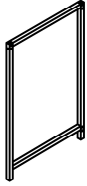
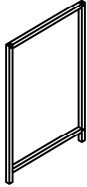
| PIÈCE / PART # | IMAGE | DESCRIPTION | QTY / QTÉ |
|----------------|---|--|-----------|
| 1 |  | DESK TOP SURFACE DU BUREAU | 1 |
| 2 |  | DESK TOP SURFACE DU BUREAU | 1 |
| 3 |  | LEG PATTE | 1 |
| 4 |  | FRONT FACING LEFT LEG PATTE AVANT GAUCHE | 1 |
| 5 |  | FRONT FACING RIGHT LEG PATTE AVANT DROITE | 1 |

LISTE DES PIÈCES
PARTS LIST

| PIÈCE / PART # | IMAGE | DESCRIPTION | QTY / QTÉ |
|----------------|---|-------------------------|-----------|
| 6 |  | CONNECTOR CONNECTEUR | 1 |
| 7 |  | CONNECTOR CONNECTEUR | 1 |
| 8 |  | CONNECTOR CONNECTEUR | 1 |
| 9 |  | CONNECTOR CONNECTEUR | 1 |
| 10 |  | CONNECTOR CONNECTEUR | 1 |

LISTE DES PIÈCES DE MONTAGE
HARDWARE LIST

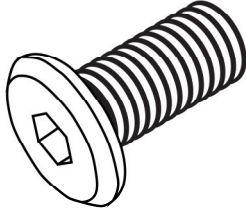
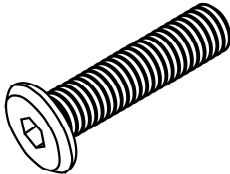
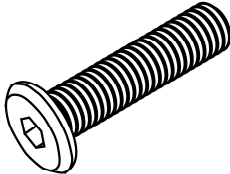
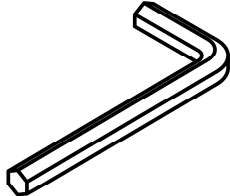
| PIÈCE / PART # | IMAGE | DESCRIPTION | QTY / QTÉ |
|----------------|---|---|-----------|
| A |  | <p align="center">ASSEMBLING BOLT - Ø 1/4" X 1/2"</p> <p align="center">BOULON D'ASSEMBLAGE - Ø 1/4" X 1/2"</p> | 9 |
| B |  | <p align="center">ASSEMBLING BOLT - Ø 1/4" X 1 1/8"</p> <p align="center">BOULON D'ASSEMBLAGE - Ø 1/4" X 1 1/8"</p> | 20 |
| C |  | <p align="center">ASSEMBLING BOLT - Ø 1/4" X 1 1/2"</p> <p align="center">BOULON D'ASSEMBLAGE - Ø 1/4" X 1 1/2"</p> | 1 |
| D |  | <p align="center">HEX KEY - M4, 3M</p> <p align="center">CLÉ HEXAGONALE - M4, 3M</p> | 1 |



OUTIL DE VÉRIFICATION DE DIMENSIONS DES PIÈCES
HARDWARE DIMENSIONS VERIFICATION TOOL



ÉTAPE / STEP 1

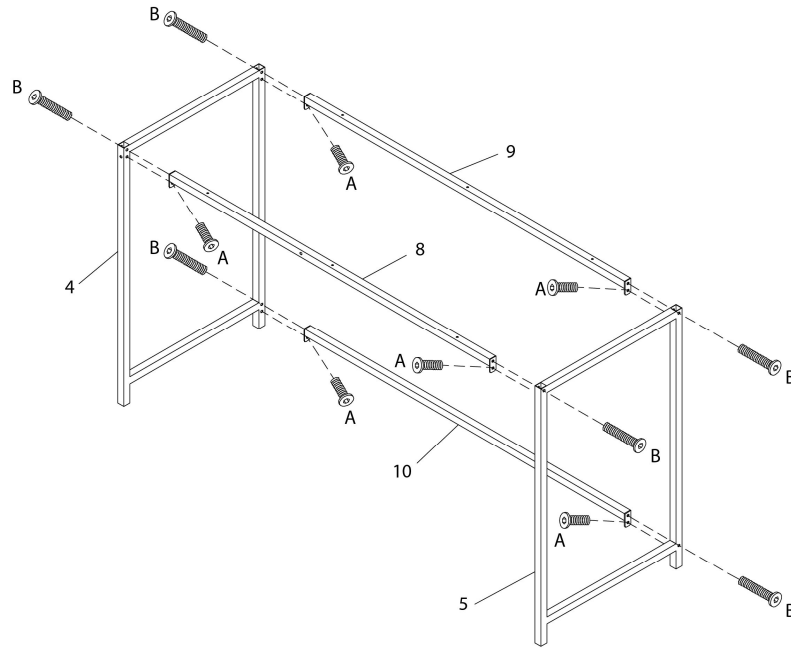

ÉTAPE / STEP 2

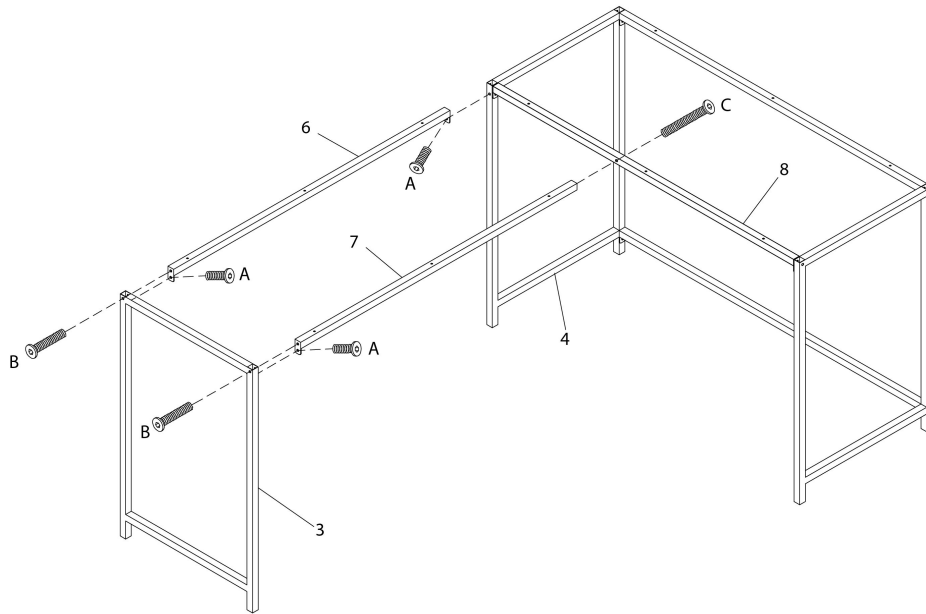

ÉTAPE / STEP 3

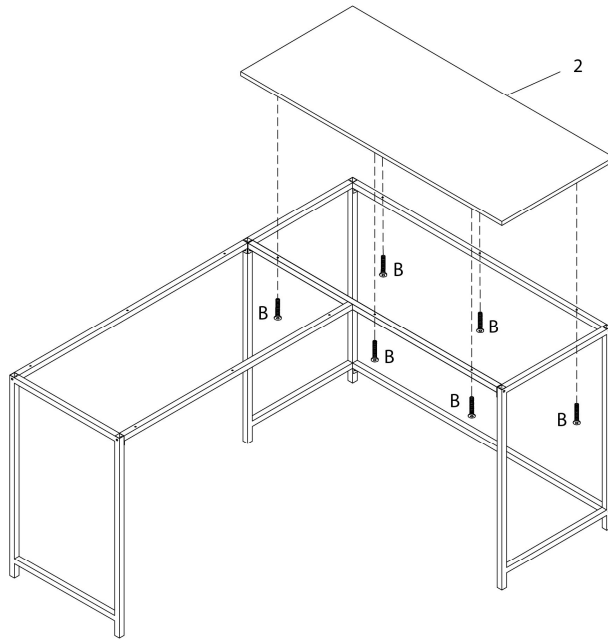

ÉTAPE / STEP 4

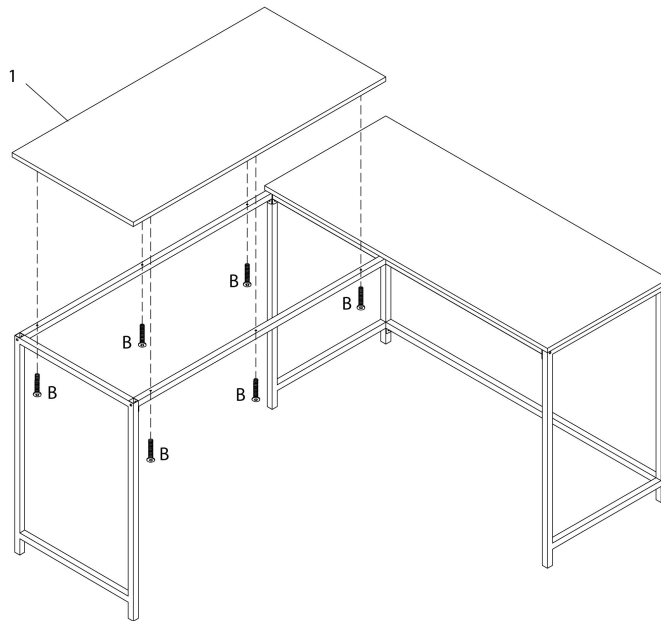

ÉTAPE / STEP 5

