



**INSTRUCTIONS D'ASSEMBLAGE**  
**ASSEMBLY INSTRUCTIONS**

---

**M**ONARCH  
SPECIALTIES INC.

**I 7394**

---

**BUREAU -**  
**58"L / DESSUS NOIR DE COIN / METAL NOIR**

**COMPUTER DESK -**  
**58"L / BLACK TOP / BLACK METAL CORNER**



**POUR DE L'ASSISTANCE OU POUR COMMANDER  
DES PIÈCES CONTACTEZ NOTRE DÉPARTEMENT  
DE SERVICE À LA CLIENTÈLE.**

**FOR ASSISTANCE OR TO ORDER PARTS  
CONTACT OUR CUSTOMER SERVICE DEPARTMENT**

**WWW.MONARCHSERVICE.COM**

**LISTE DES PIÈCES**  
**PARTS LIST**

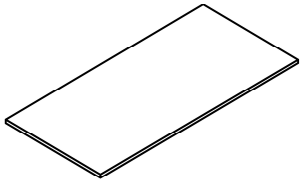
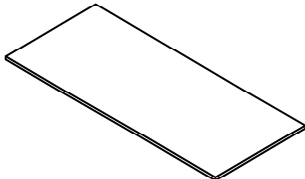
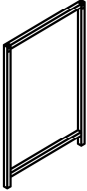
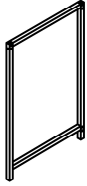
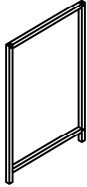
PIÈCE / PART #	IMAGE	DESCRIPTION	QTY / QTÉ
1		DESK TOP SURFACE DU BUREAU	1
2		DESK TOP SURFACE DU BUREAU	1
3		LEG PATTE	1
4		FRONT FACING LEFT LEG PATTE AVANT GAUCHE	1
5		FRONT FACING RIGHT LEG PATTE AVANT DROITE	1

**LISTE DES PIÈCES**  
**PARTS LIST**

PIÈCE / PART #	IMAGE	DESCRIPTION	QTY / QTÉ
6		CONNECTOR CONNECTEUR	1
7		CONNECTOR CONNECTEUR	1
8		CONNECTOR CONNECTEUR	1
9		CONNECTOR CONNECTEUR	1
10		CONNECTOR CONNECTEUR	1

**LISTE DES PIÈCES DE MONTAGE**  
**HARDWARE LIST**

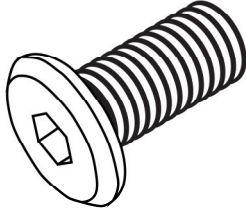
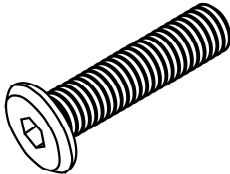
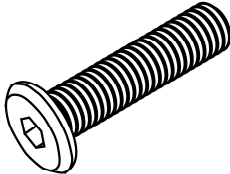
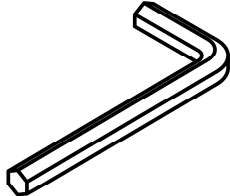
PIÈCE / PART #	IMAGE	DESCRIPTION	QTY / QTÉ
A		<p align="center">ASSEMBLING BOLT - Ø 1/4" X 1/2"</p> <p align="center">BOULON D'ASSEMBLAGE - Ø 1/4" X 1/2"</p>	9
B		<p align="center">ASSEMBLING BOLT - Ø 1/4" X 1 1/8"</p> <p align="center">BOULON D'ASSEMBLAGE - Ø 1/4" X 1 1/8"</p>	20
C		<p align="center">ASSEMBLING BOLT - Ø 1/4" X 1 1/2"</p> <p align="center">BOULON D'ASSEMBLAGE - Ø 1/4" X 1 1/2"</p>	1
D		<p align="center">HEX KEY - M4, 3M</p> <p align="center">CLÉ HEXAGONALE - M4, 3M</p>	1



OUTIL DE VÉRIFICATION DE DIMENSIONS DES PIÈCES  
HARDWARE DIMENSIONS VERIFICATION TOOL



ÉTAPE / STEP 1

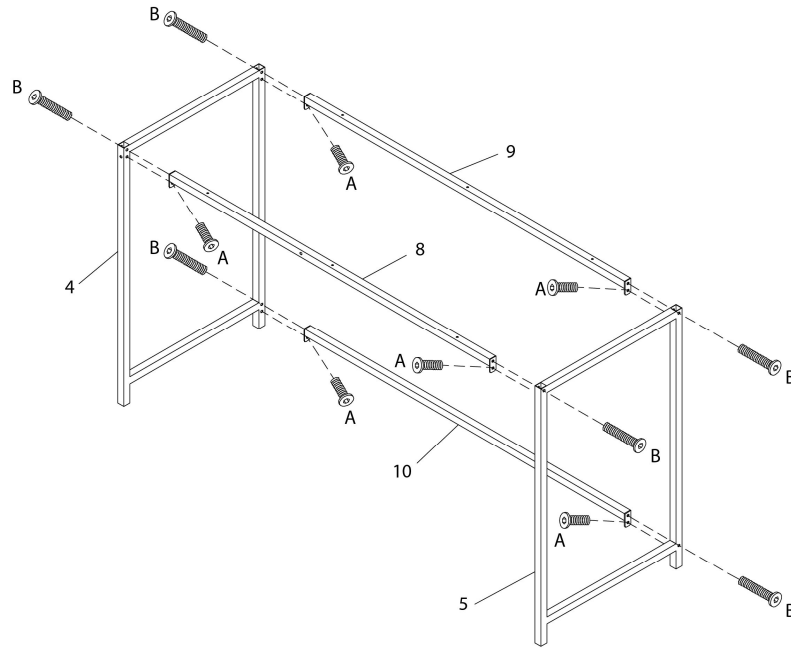

ÉTAPE / STEP 2

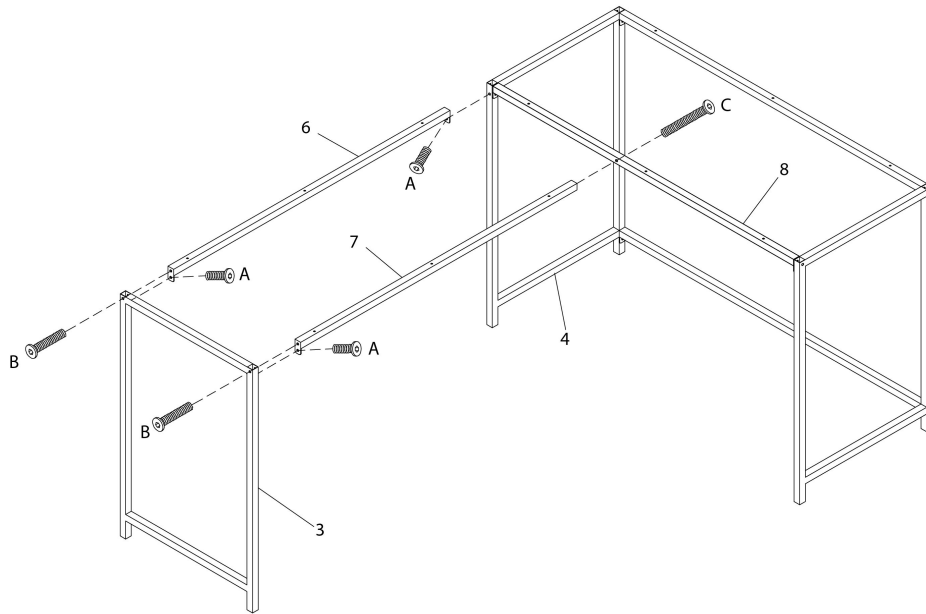

ÉTAPE / STEP 3

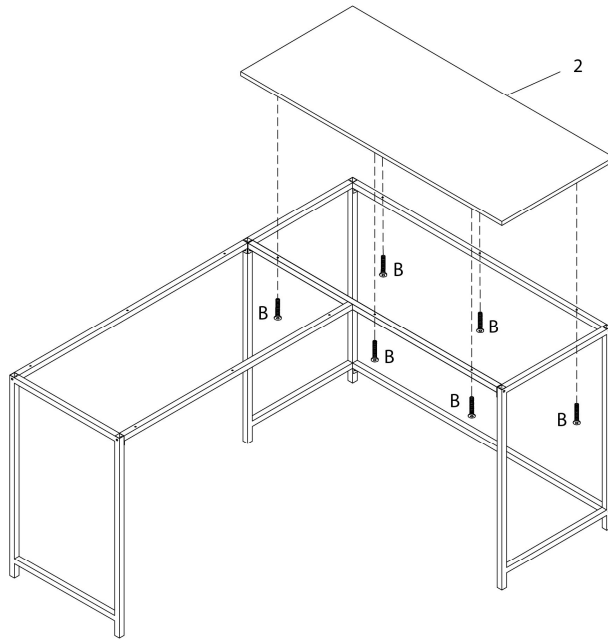

ÉTAPE / STEP 4

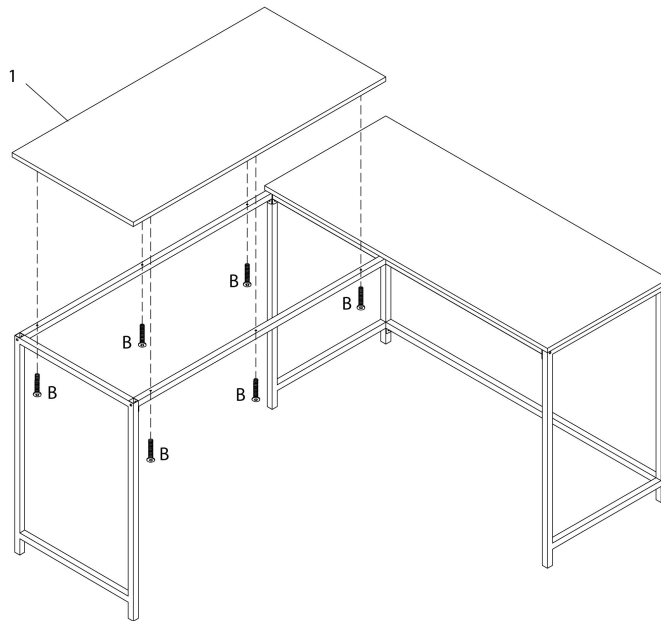

ÉTAPE / STEP 5

