



INSTRUCTIONS D'ASSEMBLAGE
ASSEMBLY INSTRUCTIONS

MONARCH
SPECIALTIES INC.

I 7297

CHAISE DE BUREAU -
NOIR / GRIS FONCE / MULTIPLE POSITION

OFFICE CHAIR -
BLACK / DARK GREY FABRIC / MULTI POSITION





POUR DE L'ASSISTANCE OU POUR COMMANDER
DES PIÈCES CONTACTEZ NOTRE DÉPARTEMENT
DE SERVICE À LA CLIENTÈLE.

FOR ASSISTANCE OR TO ORDER PARTS
CONTACT OUR CUSTOMER SERVICE DEPARTMENT

WWW.MONARCHSERVICE.COM

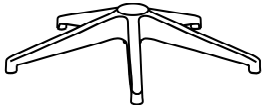
LISTE DES PIÈCES
PARTS LIST

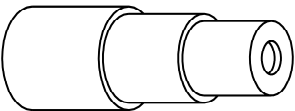
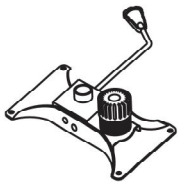
PIÈCE / PART #	IMAGE	DESCRIPTION	QTY / QTÉ
1		CASTOR ROULLETTE	5
2		BASE BASE	1
3		GASLIFT ASCENSEUR À ESSENCE	1
4		TELESCOPIC COLUMN COVER COUVERTURE DE COLONNE TÉLÉSCOPIQUE	1
5		CHAIR MECHANISM SEAT PLATE MÉCANISME DE SIÈGE	1

LISTE DES PIÈCES
PARTS LIST

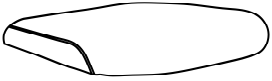
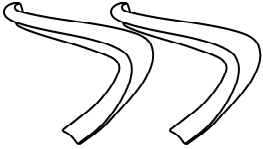
PIÈCE / PART #	IMAGE	DESCRIPTION	QTY / QTÉ
6		<p>BACK REST DOSSIER</p>	1
7		<p>SEAT CUSHION COUSSIN DU SIÈGE</p>	1
8		<p>ARM REST ACCOUDOIR</p>	2

LISTE DES PIÈCES DE MONTAGE
HARDWARE LIST

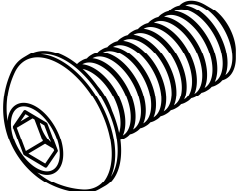
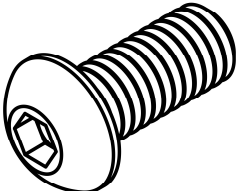
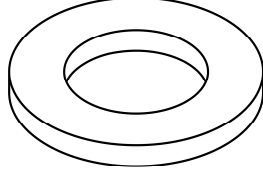
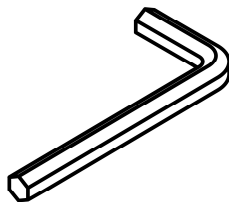
PIÈCE / PART #	IMAGE	DESCRIPTION	QTY / QTÉ
A		<p align="center">ASSEMBLING BOLT - Ø 1/4" X 3/4" BOULON D'ASSEMBLAGE - Ø 1/4" X 3/4"</p>	6
B		<p align="center">ASSEMBLING BOLT - Ø 1/4" X 1 1/4" BOULON D'ASSEMBLAGE - Ø 1/4" X 1 1/4"</p>	10
C		<p align="center">METAL WASHER RONDELLE DE MÉTAL</p>	10
D		<p align="center">HEX KEY CLÉ HEXAGONALE</p>	1



OUTIL DE VÉRIFICATION DE DIMENSIONS DES PIÈCES
HARDWARE DIMENSIONS VERIFICATION TOOL



ÉTAPE / STEP 1

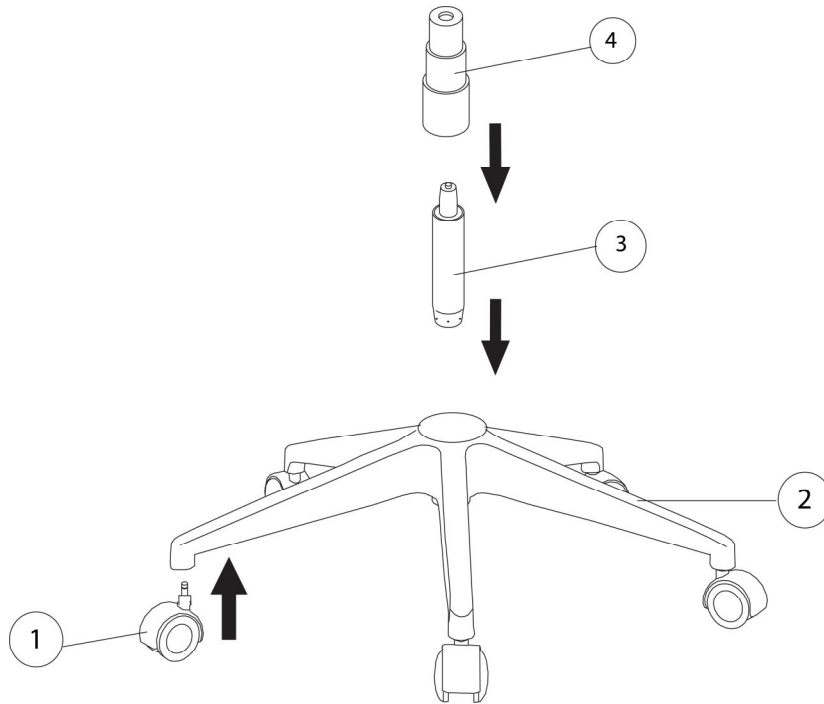

ÉTAPE / STEP 2

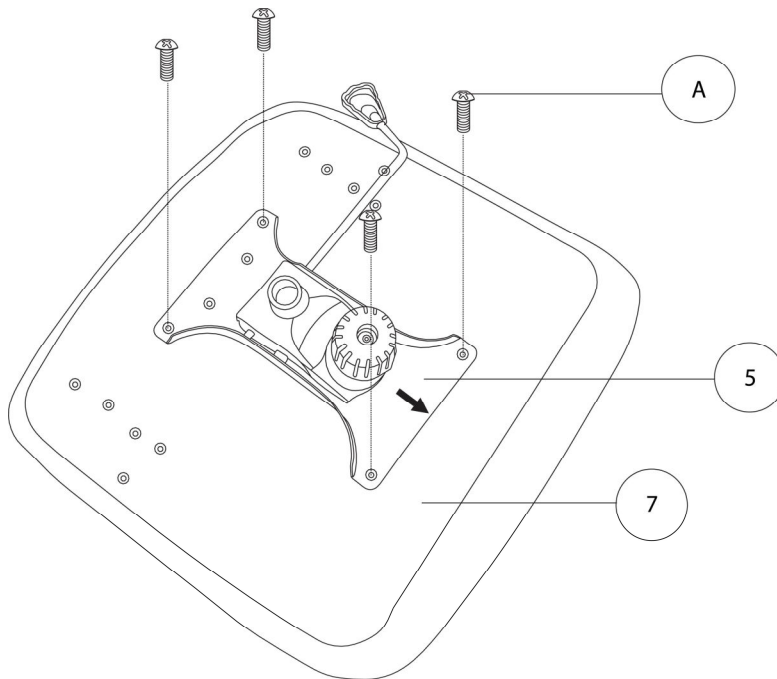

ÉTAPE / STEP 3

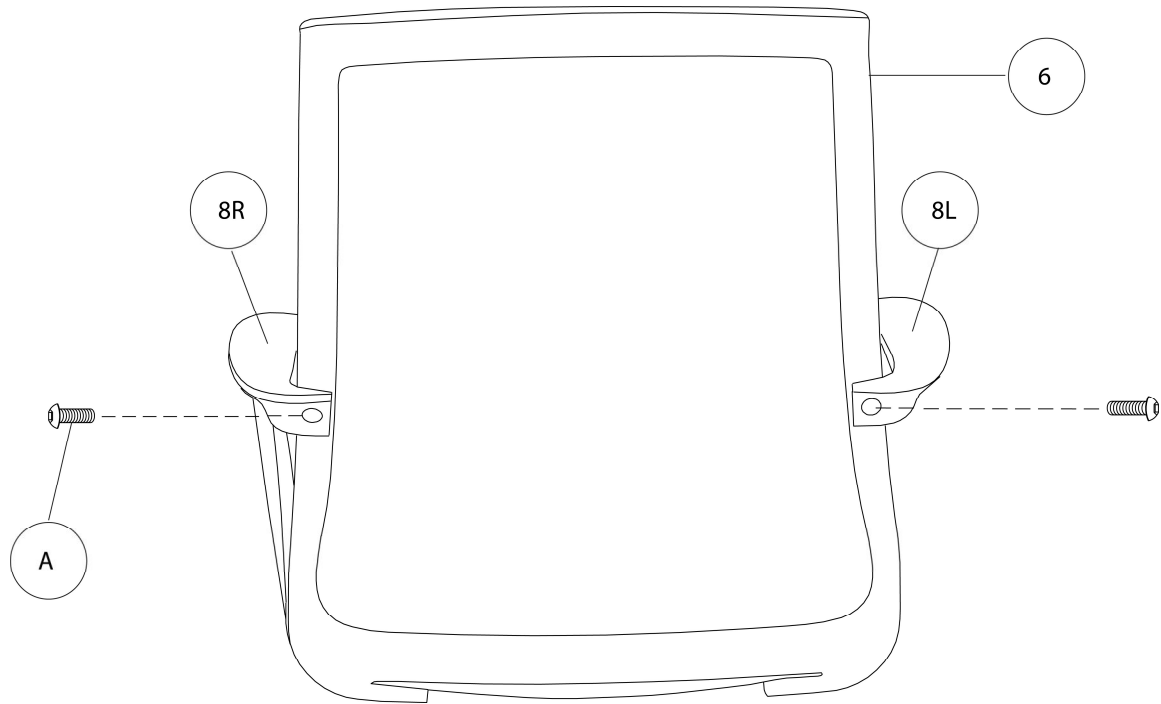

ÉTAPE / STEP 4

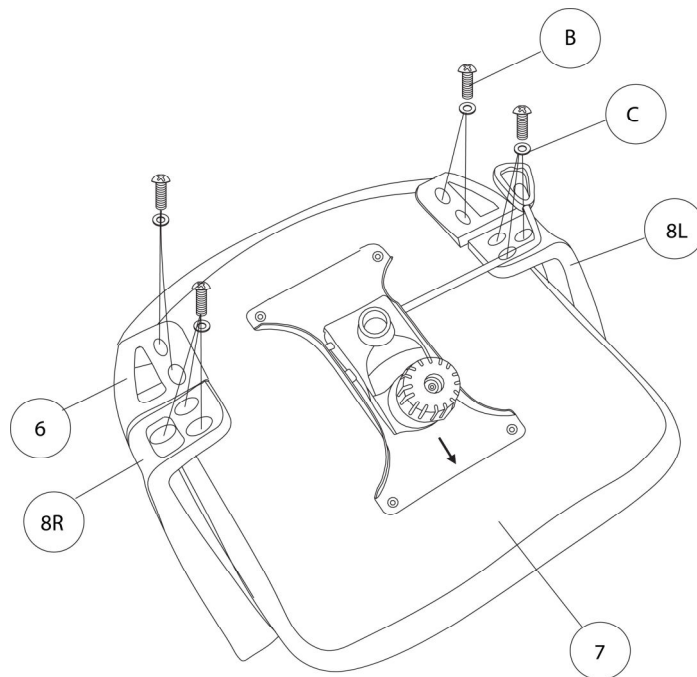

ÉTAPE / STEP 5

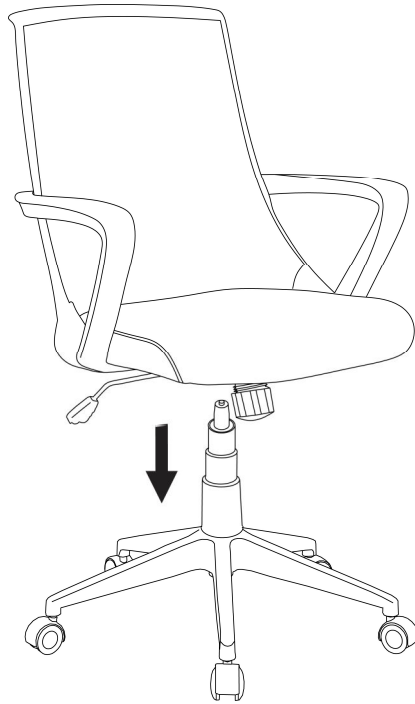

ÉTAPE / STEP 6

