

CLASSICO WP28M SERIES RANGE HOOD

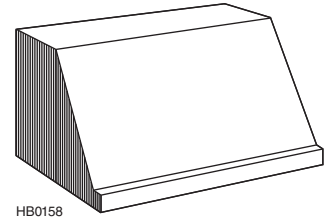

Timeless canopy style has been the standard of excellence. Classico provides high ventilation and durable construction to meet the needs of professional-style cooking appliances.

A complete installation requires several optional components. Refer to pages 2, 3 & 4 when planning your installation.

FEATURES

- 430 Stainless Steel construction - 22 gauge
- Hood width: 30", 36", 42", 48", 54", 60"
- Halogen lighting (2 x 50 watt GU10 for 30", 36" and 42" hood, 4 x 50 watt GU10 for 48", 54" and 60" hood) Lamps included
- Infinite speed rotary blower control with on-off rocker switch
- Easily accessible, dishwasher-safe hybrid filters
- Heat Sentry turns blower ON to HIGH speed when excess heat is detected
- For indoor use only

OPTION

- Backsplash (RMP Series): Widths - 30" to 60" in 6" increments. Stainless Steel construction - protects back wall and wipes clean easily
- Decorative flue (AEWP28 Series): Widths - 30" to 60" in 6" increments
Stainless Steel construction - hides ducting and wipes clean easily
- Designed for use with interior blower models P3, P6, P12, iQ6 or iQ12; exterior blower models EB6, EB9, EB12, or EB15; and in-line blower models ILB3, ILB6, ILB9 or ILB11 (Purchase blowers separately)

SPECIFICATIONS

- 120 VAC, 60 Hz
- Amps for 30", 36" and 42" hoods (without blower): 0.8 A
- Amps for 48", 54" and 60" hoods (without blower): 1.7 A

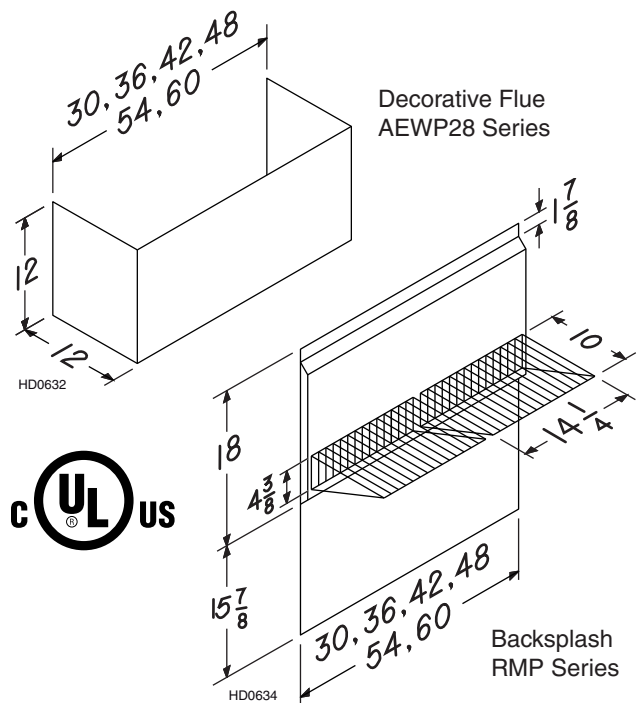
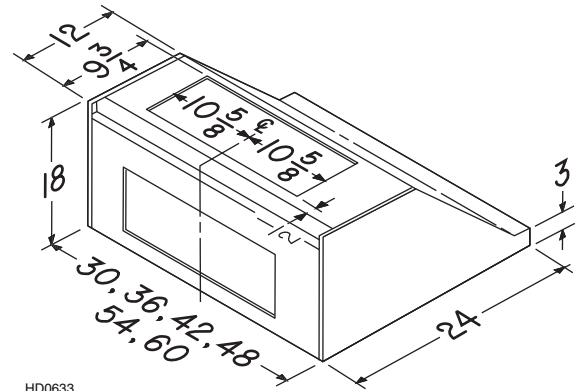

NOTE: DIMENSIONS SHOWN ARE IN INCHES

BEST Drummondville, QC Canada www.BestRangeHoods.ca 866-737-7770

REFERENCE	QTY.	REMARKS	Project
			Location
			Architect
			Engineer
			Contractor
			Submitted by Date

- WP28M SERIES RANGE HOOD SYSTEMS - INTERIOR BLOWERS

MODEL 437
(HIGH CAPACITY ROOF CAP)

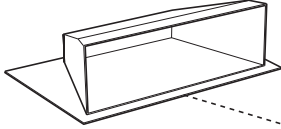

MODEL 441
(10" ROUND WALL CAP)

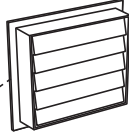

MODEL 634 OR 644
(ROOF CAP)

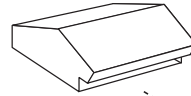

MODEL 643
(8" ROUND WALL CAP)

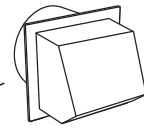

MODEL 418
(10" ROUND
ADJUSTABLE ELBOW,
OPTIONAL)

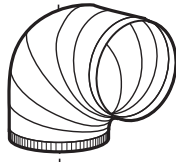

8" ROUND
ADJUSTABLE ELBOW,
OPTIONAL

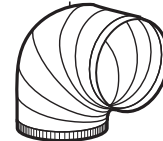

MODEL 410
(10" ROUND DUCT—
2 FT. SECTIONS)

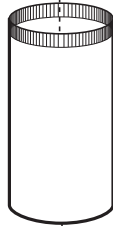

8" ROUND
STANDARD DUCT

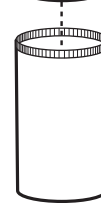

OPTIONAL
AERP28 SERIES
DECORATIVE FLUE



MODEL 421
(10" ROUND VERTICAL
IN-LINE DAMPER,
INCLUDED WITH IQ12 AND P12
BLOWER/ROUGH-IN KIT)



8" ROUND ADAPTER/DAMPER
(INCLUDED WITH IQ6, P3
AND P6 BLOWER/ROUGH-IN KIT)

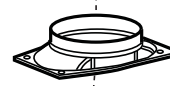

WP28M SERIES HOOD
(CANOPY WITH BLOWER
CONTROLS & LIGHTING.
REQUIRED FOR ALL INSTALLATIONS.)

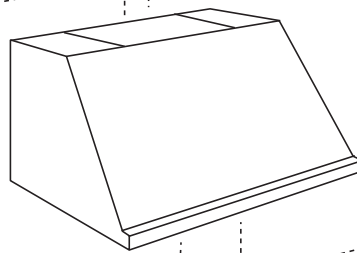

**MODEL IQ12 OR P12
BLOWER/ROUGH-IN KIT**
(1200 CFM INTERIOR BLOWER &
ROUGH-IN PLATE)

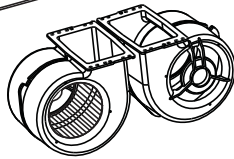
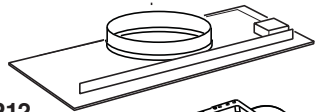

**OPTIONAL RMP SERIES
BACKSPLASH**
(STAINLESS STEEL WALL COVERING
WITH SHELVES)

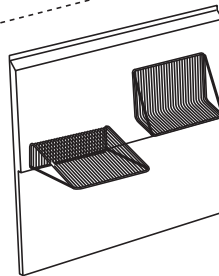

**MODEL IQ6, P3 OR P6
BLOWER/ROUGH-IN KIT**
(600 CFM (EXCEPT 300 CFM
FOR P3) INTERIOR BLOWER
& ROUGH-IN PLATE)

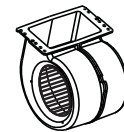
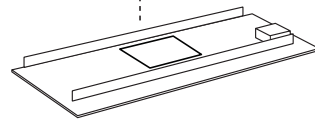

HL0170

- WP28M SERIES RANGE HOOD SYSTEMS - IN-LINE AND EXTERIOR BLOWERS

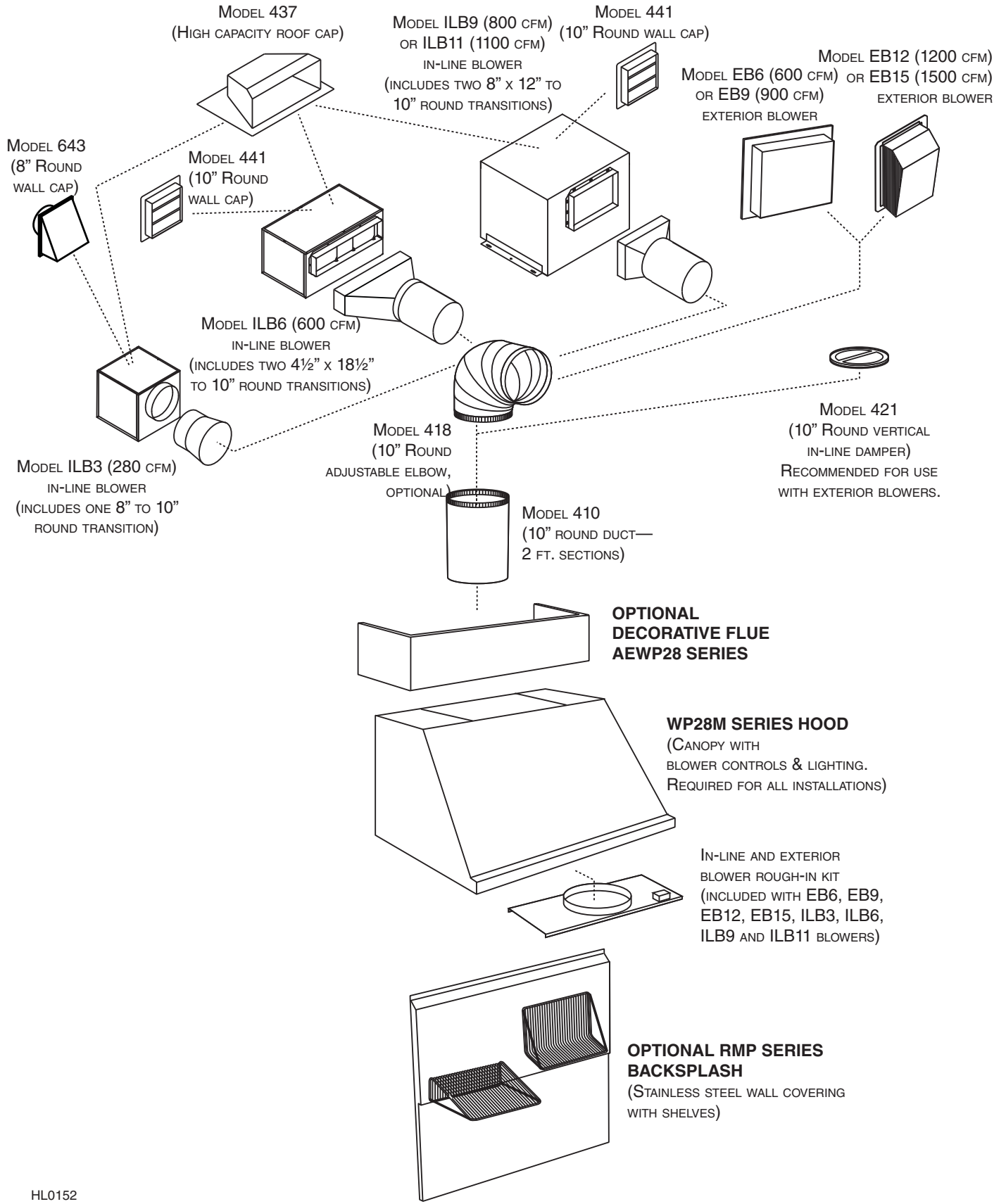

HL0152

- WP28M SERIES RANGE HOOD SYSTEM - BLOWER DUCTING POSITION

BLOWER DUCTING POSITION

(Choice of transition will determine the final duct placement.)

MODEL EB6, EB9, EB12, EB15, ILB3, ILB6, ILB9, ILB11, P12 & iQ12:

Horizontal outlet
back view

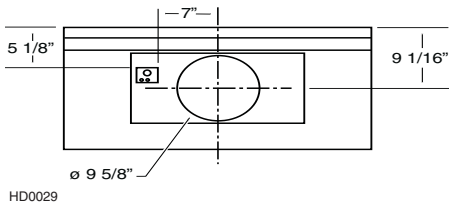

Vertical outlet
top view

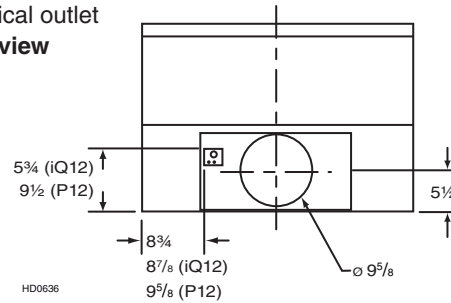

MODEL P6 & iQ6:

Horizontal outlet
back view

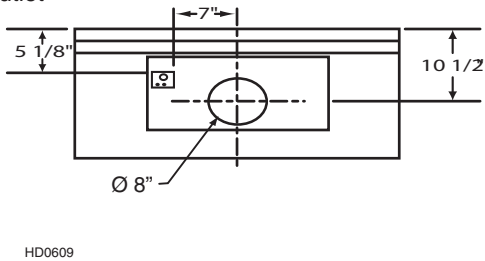

Vertical outlet
top view

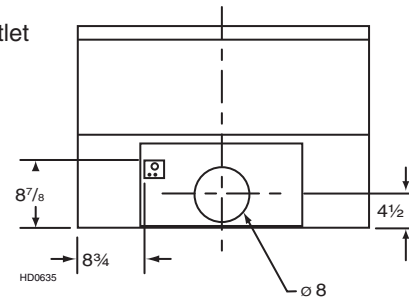

Note: The electrical box dimensions are 2.5" x 3"