

Installation Requirements

Tools and Parts

Removing the packaging

CAUTION











Remove the carton carefully. Wear gloves to protect against sharp edges.

WARNING

Remove the protective film covering the product before putting into operation.

Parts supplied

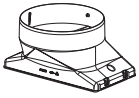
- Hood assembly with blower and LED lamps already installed.
- Hardware bag with:

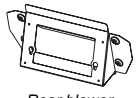
Part	Qty	Part	Qty
 5x45 mm	4	 5.4x75 mm screws (for 10x60 mm wall anchors)	4
 4.5x13 mm	4	 10 x 60 mm	4
 3.5x9.5 mm	2	 Torx 10 adapter	1
 4.2x8 mm	7	 Torx 20 adapter	1
 6" (15.2 cm) round transition	1	 Rectangular transition 3 3/4" x 10" (8.3 x 25.4 cm) with back draft dampers	1
 Rear blower mounting bracket	1		

Tools/Materials required

- Level
- Drill with 1/4" (3.2 cm), 1/8" (3.2 mm), and 1/16" (4,8 mm) drill bits
- Pencil
- Wire stripper or utility knife
- Tape measure or ruler
- Pliers
- Caulking gun and weatherproof caulking compound
- Vent clamps
- Jigsaw or keyhole saw
- Flat-blade screwdriver
- Metal snips
- Phillips & Torx 20 screwdriver

Parts needed

- Home power supply cable
- 1/2" (12.7 mm) UL listed or CSA approved strain relief
- 3 UL listed wire connectors
- 1 wall or roof cap
- Metal vent system

Dimensions and Clearances

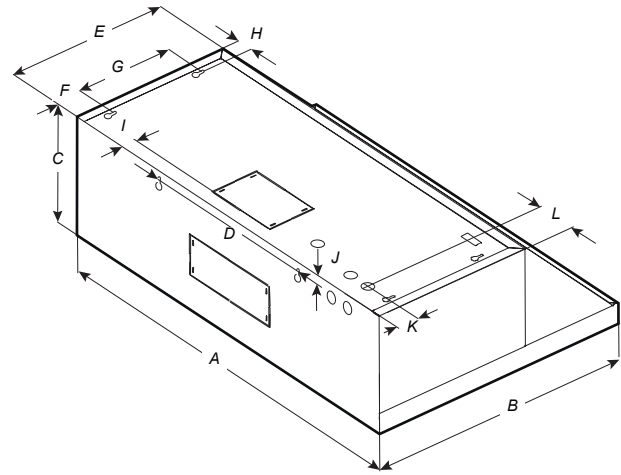

	NK30N7000US NK30N7000UG	NK36N7000US NK36N7000UG
A	30" (76 cm)	36" (91.2 cm)
B	19 1/8" (50 cm)	
C	9 3/4" (25 cm)	
D	13 13/16" (35 cm)	
E	12" (30.5 cm)	
F	2 3/16" (5.5 cm)	
G	7 1/4" (18.4 cm)	
H	1 1/16" (3 cm)	
I	1 1/16" (2.6 cm)	
J	5/8" (1.6 cm)	
K	1 10/16" (4 cm)	
L	3" (7.6 cm)	5 3/4" (14.6 cm)

Accessories

Model	NK30N7000US - NK36N7000US NK30N7000UG - NK36N7000UG
Charcoal Filter Kit	NK-AR050FNB/AA
Recirculation Kit	NK-AF030FNB/AA