



AGArangeusa.com

36" MERCURY INDUCTION RANGE

MODEL: AMC36IN



The AGA Mercury range is known for its bold design, contemporary details, zero-clearance facade and mod style cooking controls. It is truly a statement piece in any luxury kitchen.

Designed and built in the UK, this range is a technical masterpiece, the embodiment of exquisite quality and stylish, thoughtful design. Available in 16 sophisticated finish options, The AGA Mercury range is the perfect match for any mood or lifestyle.

SPECIFICATIONS

- Electrical: Induction Zone: 11.1 kW (48A)
- Oven: 3.7kW (17A), 240V
- Electrical Rating: 240V (L1, L2 + N + Grd), 60Hz, 15.1 kW
- Cooktop Ratings:
 - Front Left: 1.4 kW (Max) 2.2 kW (Boost)
 - Rear Left: 1.85 kW (Max) 3.0 kW (Boost)
 - Center: 2.3 kW (Max) 3.7 kW (Boost)
 - Front Right: 1.85 kW (Max) 3.0 kW (Boost)
 - Rear Right: 1.85 kW (Max) 3.0 kW (Boost)
- Product Dimensions: 35 7/16" W x 26 1/8" D x 35 7/8" H
- Shipping weight (lbs): 449lbs (includes range, crate & pallet)

WARRANTY

- 2 Year Warranty on parts and labor with exception of cosmetic parts & lightbulbs

FINISHES

NOTE: Colors not in stock could have a 4-12 week lead time (check for availability). Ranges manufactured using Soho colors are only available with stainless steel fascia.

CLASSIC COLOR COLLECTION

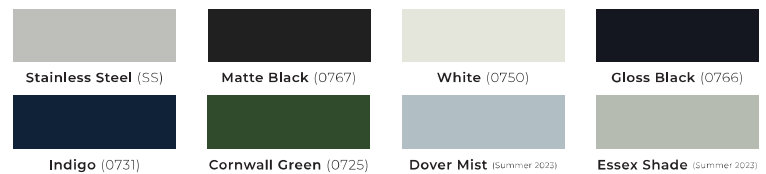

SOHO COLOR COLLECTION



OPTIONAL KNOB FINISH

NOTE: The AGA Mercury ships standard with Stainless Steel Knobs, but also has a Black finish option available as an after-market purchase.

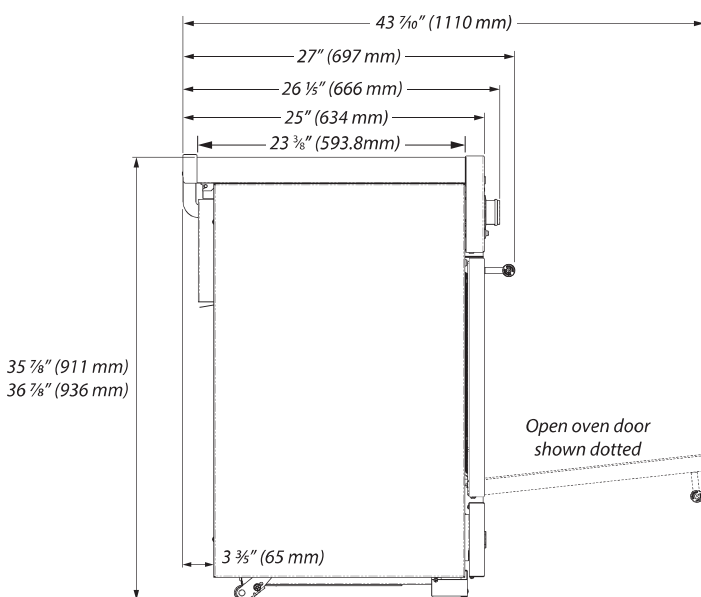
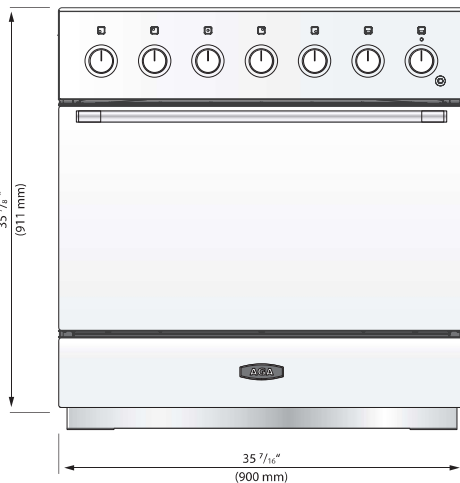



36" MERCURY INDUCTION RANGE

5 BURNER INDUCTION COOKTOP

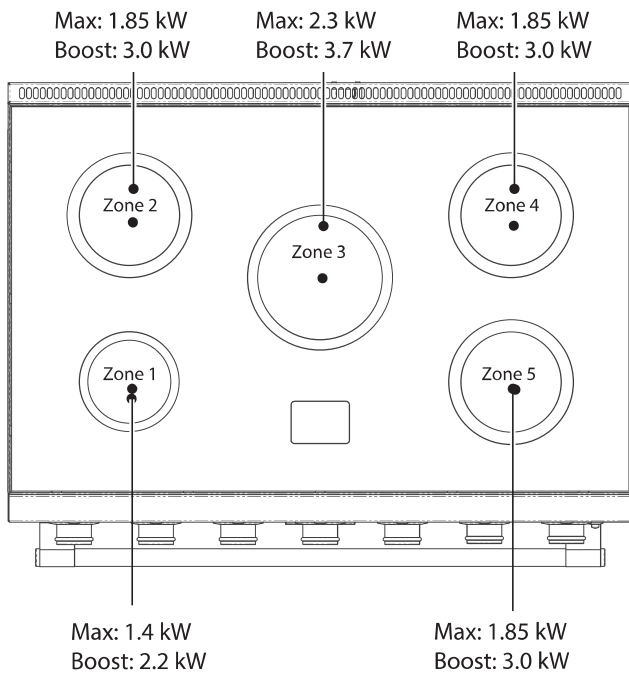

7 MULTIFUNCTION COOKING MODES

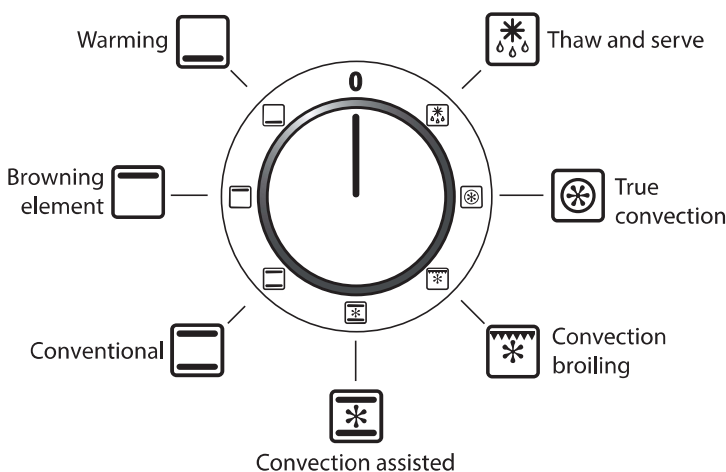

FEATURES

- Professional 5 burner induction cooktop
 - 13 temperature settings*
 - One 9" 2300W burner with 3700W power boost*
 - Three 7" 1850W burners with 3000W power boost*
 - One 6" 1400W burner with 2200W power*
- Cooktop constructed of durable ceramic glass that easily wipes clean
- 7-Mode Multifunction Oven with European Dual-Convection Cooking, Fan-Assisted Baking, Browning, Thaw-to-Serve, Convection Broiling, Warming and Conventional Cooking
- Large 4.5 cubic feet capacity — fits a 25lb turkey!
- Three heavy-duty telescoping glide-out oven racks
- Dual-pan broiler system
- True European convection with dual-fan
- Convenient storage drawer large enough to hold oven racks
- Integrated pan recognition sensors automatically shut off cooking zone when no pan is detected
- Child safety feature locks cooktop operation from unwanted use
- Heavy duty die-cast commercial grade metal control knobs