



INSTRUCTIONS D'ASSEMBLAGE  
ASSEMBLY INSTRUCTIONS

---

**M**ONARCH  
SPECIALTIES INC.

# I 2426

---

ETAGERE -  
48"H / ETAGERE D'APPOINT ESPRESSO

BOOKCASE -  
48"H / ESPRESSO ACCENT ETAGERE



POUR DE L'ASSISTANCE OU POUR COMMANDER  
DES PIÈCES CONTACTEZ NOTRE DÉPARTEMENT  
DE SERVICE À LA CLIENTÈLE.

FOR ASSISTANCE OR TO ORDER PARTS  
CONTACT OUR CUSTOMER SERVICE DEPARTMENT

[WWW.MONARCHSERVICE.COM](http://WWW.MONARCHSERVICE.COM)

---

**LISTE DES PIÈCES**  
**PARTS LIST**

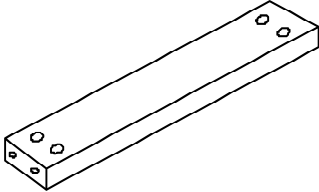
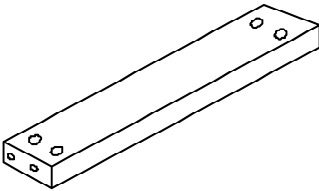
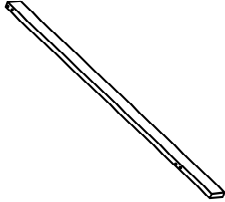
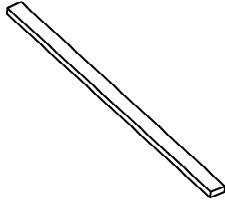
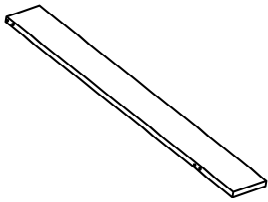
| PIÈCE / PART # | IMAGE   | DESCRIPTION                                  | QTY / QTÉ |
|----------------|---|--|-----------|
| 1              |    | TOP STRETCHER<br>CHÂSSIS SUPÉRIEUR           | 1         |
| 2              |    | TOP STRETCHER<br>CHÂSSIS SUPÉRIEUR           | 1         |
| 3              |  | FRONT FACING RIGHT LEG<br>PATTE AVANT DROITE | 1         |
| 4              |  | FRONT FACING LEFT LEG<br>PATTE AVANT GAUCHE  | 1         |
| 5              |  | BACK PANEL<br>PANNEAU ARRIÈRE                | 1         |

**LISTE DES PIÈCES**  
**PARTS LIST**

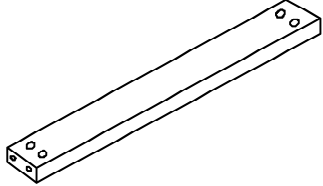
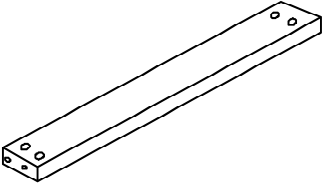
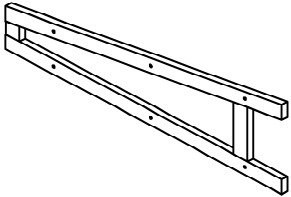
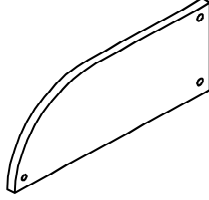
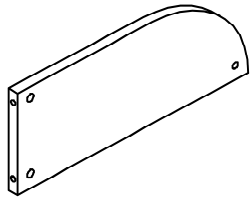
| PIÈCE / PART # | IMAGE   | DESCRIPTION                        | QTY / QTÉ |
|----------------|---|------------------------------------|-----------|
| 6              |    | BOTTOM STRETCHER<br>CHÂSSIS DU BAS | 1         |
| 7              |    | BOTTOM STRETCHER<br>CHÂSSIS DU BAS | 1         |
| 8              |  | LEG<br>PATTE                       | 1         |
| 9              |  | TOP SHELF<br>ÉTAGÈRE SUPÉRIEURE    | 1         |
| 10             |  | TOP SHELF<br>ÉTAGÈRE SUPÉRIEURE    | 1         |

**LISTE DES PIÈCES**  
**PARTS LIST**

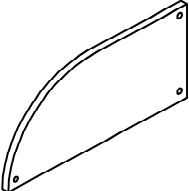
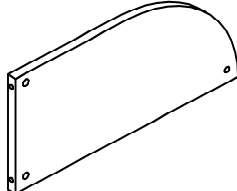
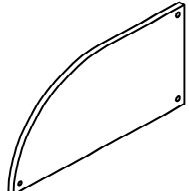
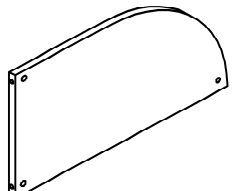
| PIÈCE / PART # | IMAGE   | DESCRIPTION                        | QTY / QTÉ |
|----------------|---|------------------------------------|-----------|
| 11             |    | SHELF PANEL<br>PANNEAU DE TABLETTE | 1         |
| 12             |    | SHELF PANEL<br>PANNEAU DE TABLETTE | 1         |
| 13             |  | BOTTOM SHELF<br>ÉTAGÈRE DU BAS     | 1         |
| 14             |  | BOTTOM SHELF<br>ÉTAGÈRE DU BAS     | 1         |

**LISTE DES PIÈCES DE MONTAGE**  
**HARDWARE LIST**

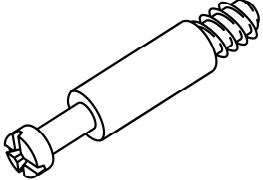
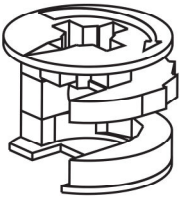
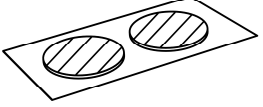
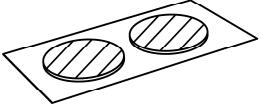
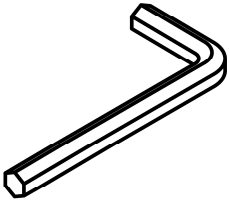
| PIÈCE / PART # | IMAGE  | DESCRIPTION  | QTY / QTÉ |
|----------------|--|--|-----------|
| A              |         | CAM LOCK SCREW -<br>1 1/8"<br>VIS CAM LOCK -<br>1 1/8"         | 20        |
| B              |         | CAM LOCK CONNECTOR -<br>Ø5/8"<br>ÉCROU CAM LOCK -<br>Ø5/8"     | 20        |
| C              |  | FINISHING STICKER -<br>Ø3/4"<br>COLLANT DE FINITION -<br>Ø3/4" | 8         |
| D              |  | FINISHING STICKER -<br>Ø1/2"<br>COLLANT DE FINITION -<br>Ø1/2" | 4         |
| E              |       | HEX KEY<br>CLÉ HEXAGONALE                                      | 1         |

**LISTE DES PIÈCES DE MONTAGE**  
**HARDWARE LIST**

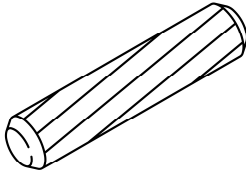
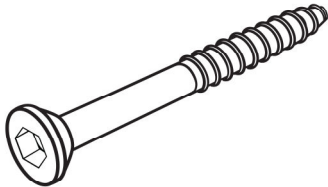
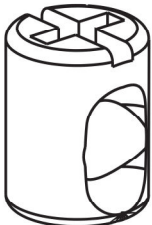
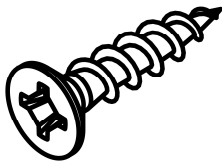
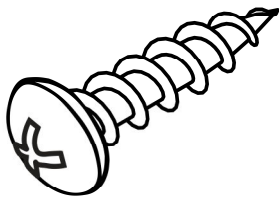
| PIÈCE / PART # | IMAGE   | DESCRIPTION  | QTY / QTÉ |
|----------------|---|--|-----------|
| F              |    | WOOD DOWEL -<br>Ø3/8" X 1"<br>GOUJON DE BOIS -<br>Ø3/8" X 1"                 | 10        |
| G              |    | ASSEMBLING SCREW -<br>Ø1/4" X 2 5/8"<br>VIS D'ASSEMBLAGE -<br>Ø1/4" X 2 5/8" | 6         |
| H              |  | BARREL NUT -<br>Ø1/4" X 1/2"<br>ÉCROU DE CANON -<br>Ø1/4" X 1/2"             | 6         |
| I              |  | ASSEMBLING SCREW -<br>Ø1/8" X 1 1/2"<br>VIS D'ASSEMBLAGE -<br>Ø1/8" X 1 1/2" | 12        |
| J              |  | ASSEMBLING SCREW -<br>Ø1/8" X 1"<br>VIS D'ASSEMBLAGE -<br>Ø1/8" X 1"         | 1         |

**LISTE DES PIÈCES DE MONTAGE**  
**HARDWARE LIST**

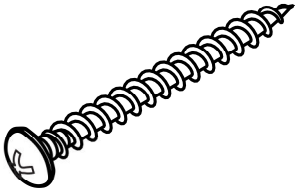
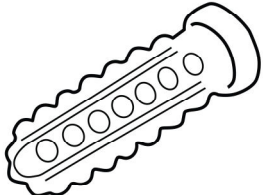
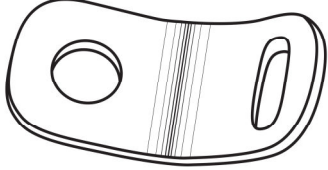
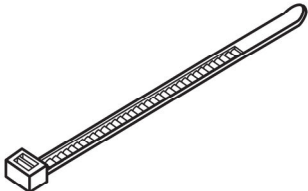
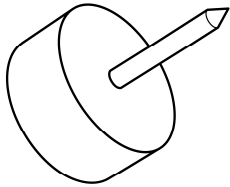
| PIÈCE / PART # | IMAGE   | DESCRIPTION  | QTY / QTÉ |
|----------------|---|--|-----------|
| K              |    | ASSEMBLING SCREW -<br>Ø1/8" X 1 1/2"<br>VIS D'ASSEMBLAGE -<br>Ø1/8" X 1 1/2" | 1         |
| L              |    | ANCHOR -<br>Ø3/8" X 1 1/2"<br>ANCRE -<br>Ø3/8" X 1 1/2"                      | 1         |
| M              |  | METAL BRACKET -<br>1/2" X 1/2"<br>SUPPORT DE MÉTAL -<br>1/2" X 1/2"          | 2         |
| N              |  | ZIP TIE -<br>7 3/4" X 1/8"<br>ATTACHE AUTOBLOQUANTE -<br>7 3/4" X 1/8"       | 1         |
| O              |  | FLOOR PROTECTOR -<br>Ø5/8"<br>PROTECTEUR DE PLANCHER -<br>Ø5/8"              | 5         |

**LISTE DES PIÈCES DE MONTAGE**  
**HARDWARE LIST**

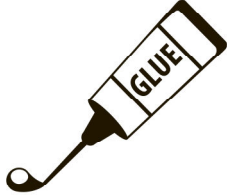
| PIÈCE / PART # | IMAGE   | DESCRIPTION                     | QTY / QTÉ |
|----------------|---|---------------------------------|-----------|
| P              |  | GLUE -<br>10G<br>COLLE -<br>10G | 1         |

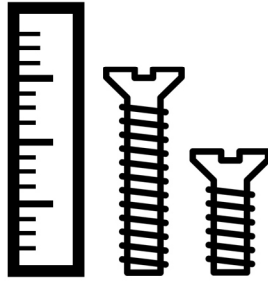

OUTIL DE VÉRIFICATION DE DIMENSIONS DES PIÈCES  
HARDWARE DIMENSIONS VERIFICATION TOOL

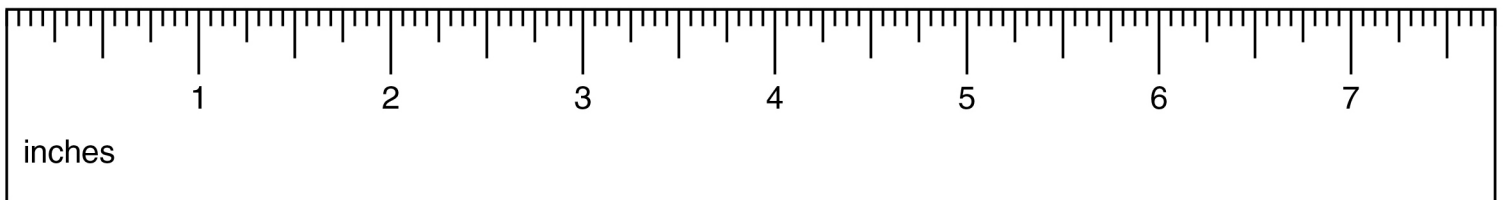

ÉTAPE / STEP 1

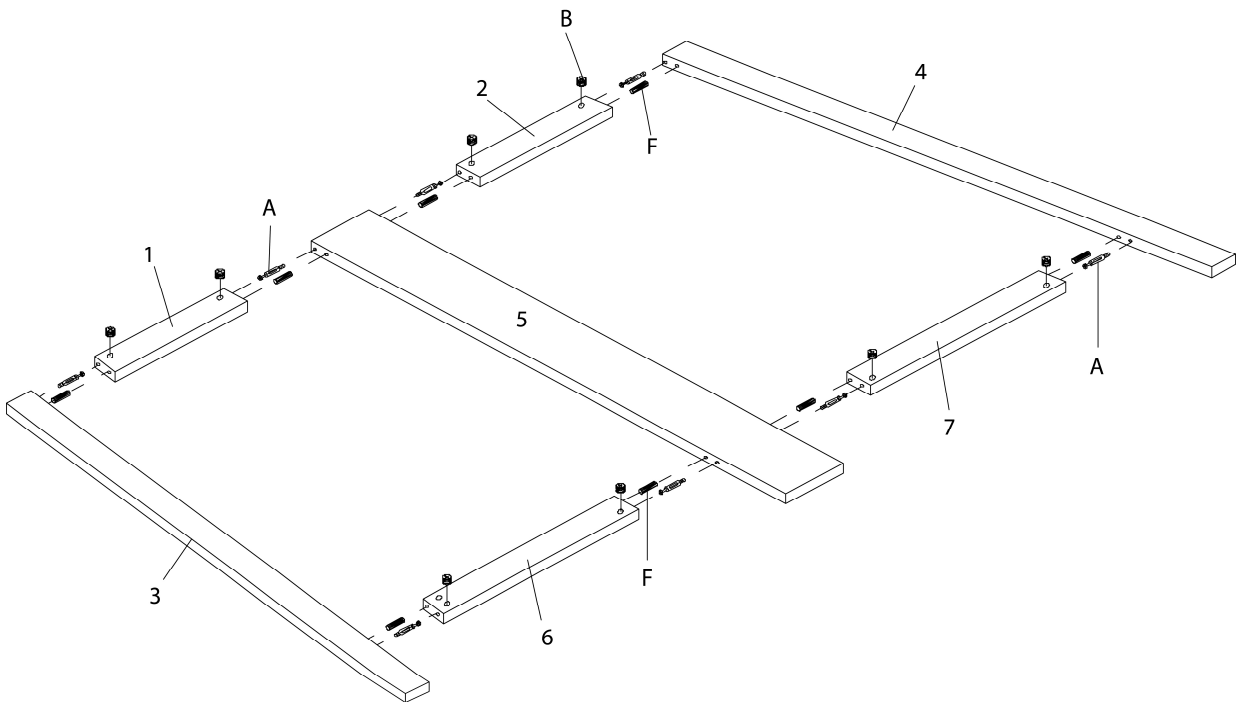

ÉTAPE / STEP 2

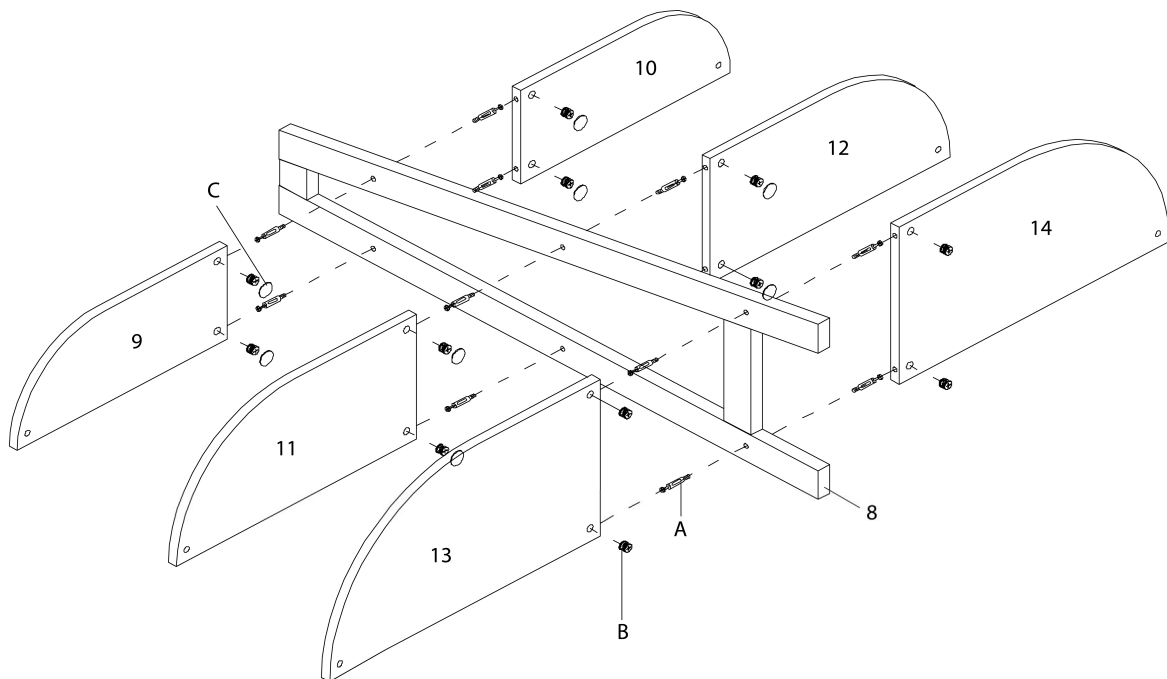

ÉTAPE / STEP 3

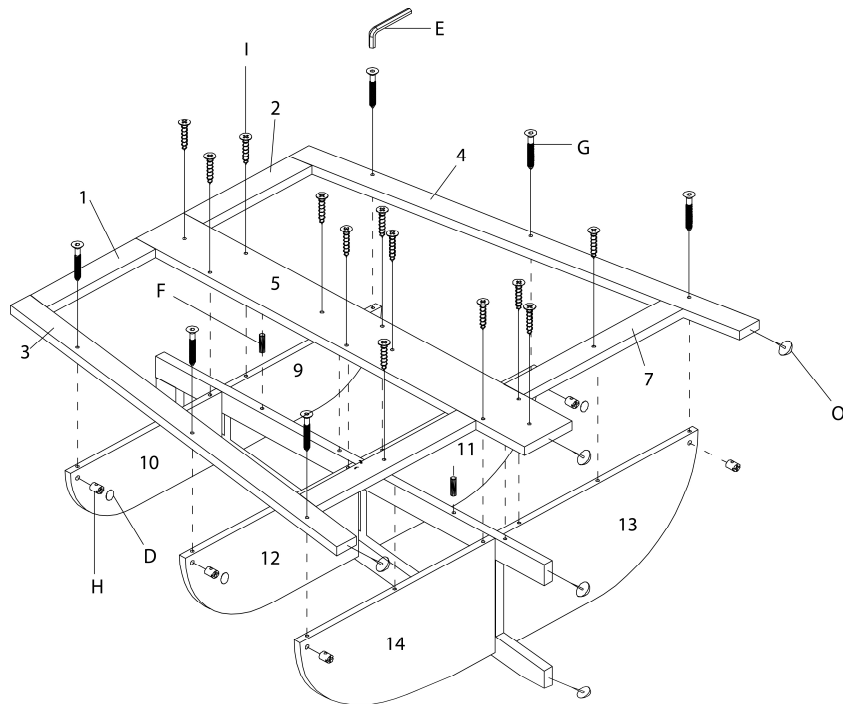

ÉTAPE / STEP 4

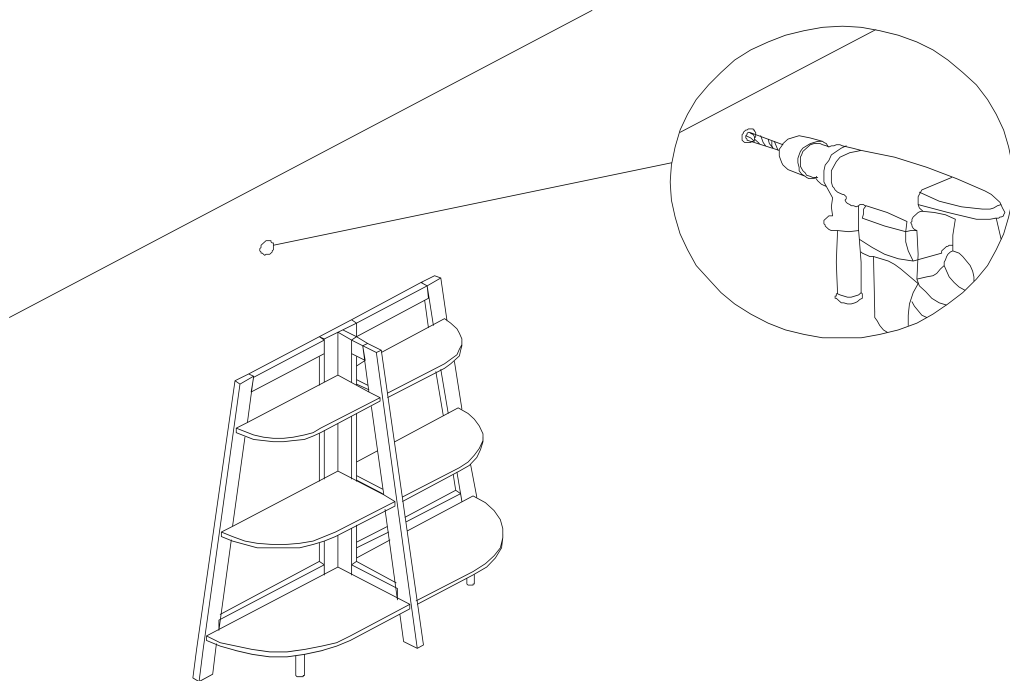

ÉTAPE / STEP 5

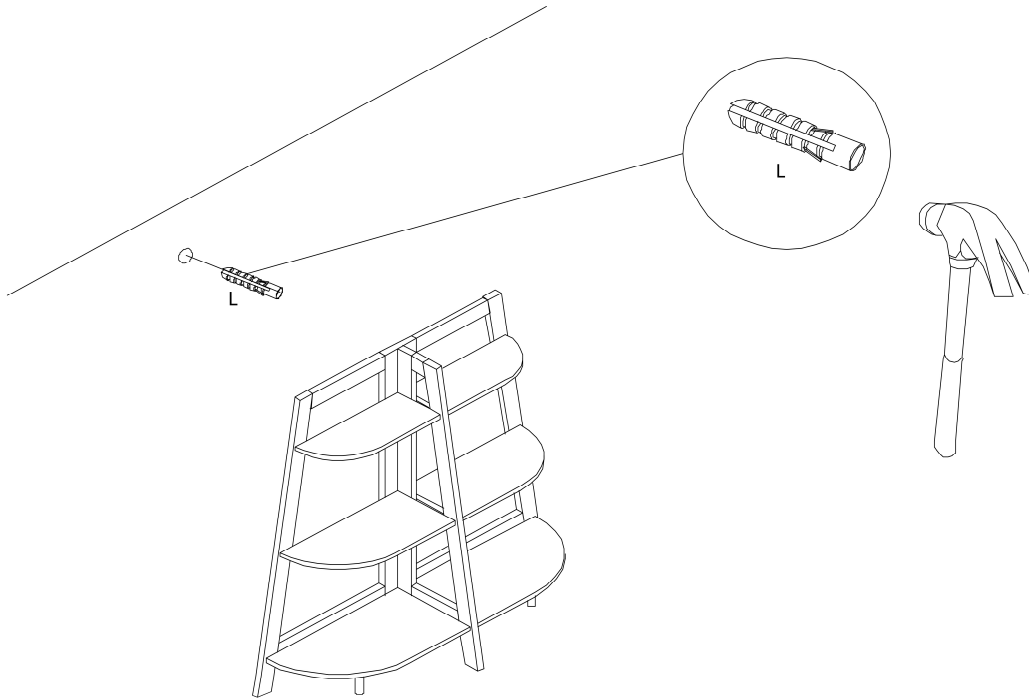

ÉTAPE / STEP 6

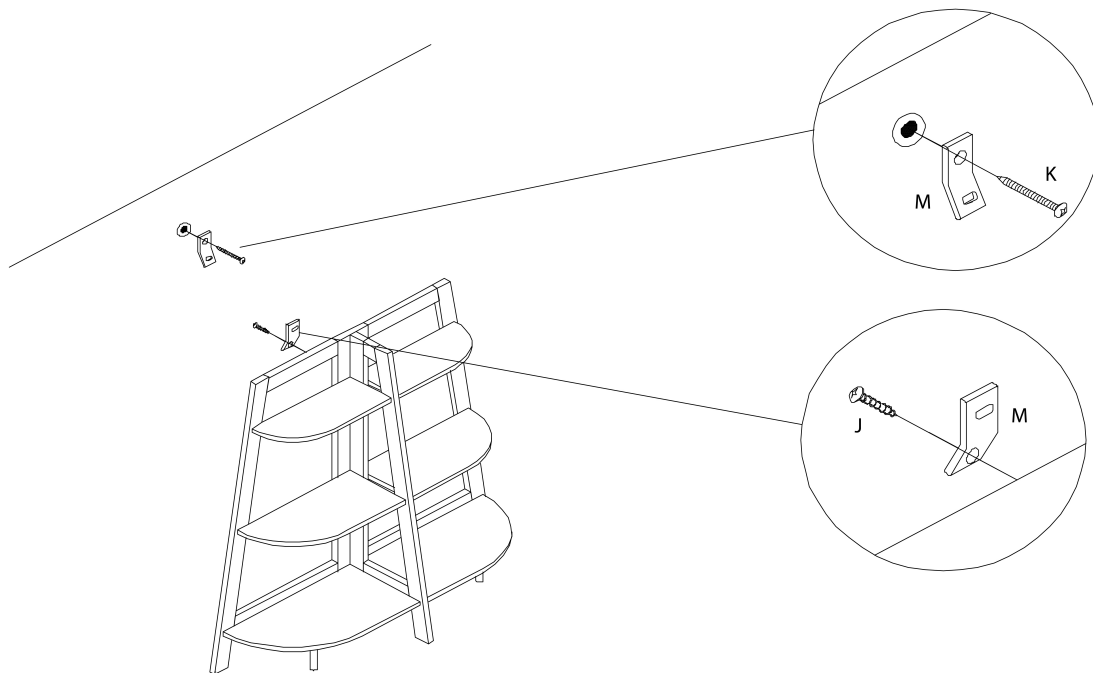

ÉTAPE / STEP 7

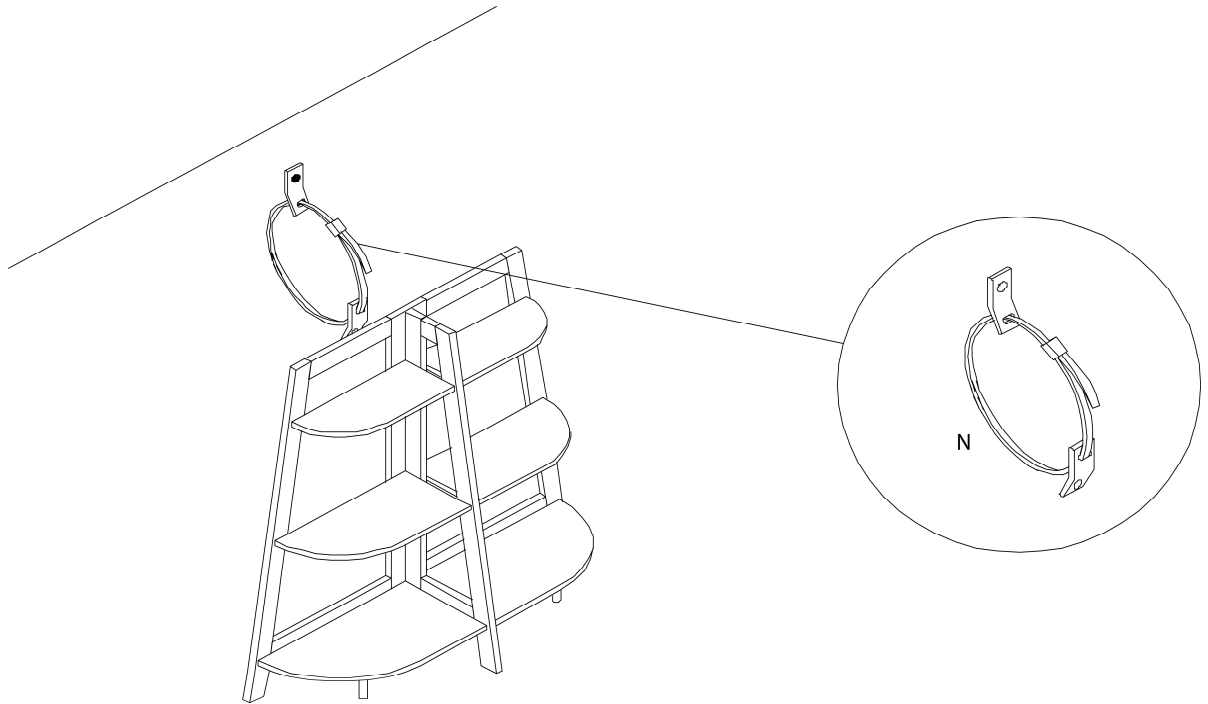

ÉTAPE / STEP 8

