



INSTRUCTIONS D'ASSEMBLAGE
ASSEMBLY INSTRUCTIONS

MONARCH
SPECIALTIES INC.

I 2427

ETAGERE -
48" H / ETAGERE D'APPOINT BLANC

BOOKCASE -
48" H / WHITE ACCENT ETAGERE



**POUR DE L'ASSISTANCE OU POUR COMMANDER
DES PIÈCES CONTACTEZ NOTRE DÉPARTEMENT
DE SERVICE À LA CLIENTÈLE.**

**FOR ASSISTANCE OR TO ORDER PARTS
CONTACT OUR CUSTOMER SERVICE DEPARTMENT**

WWW.MONARCHSERVICE.COM

LISTE DES PIÈCES
PARTS LIST

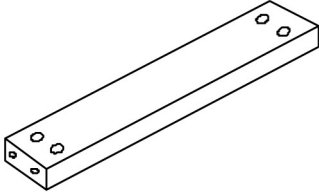
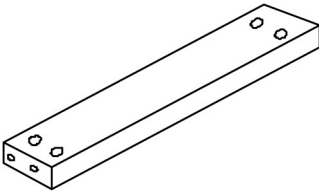
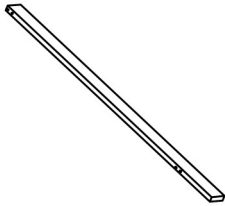
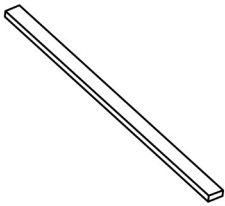
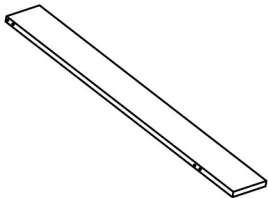
PIÈCE / PART #	IMAGE	DESCRIPTION	QTY / QTÉ
1		TOP STRETCHER CHÂSSIS SUPÉRIEUR	1
2		TOP STRETCHER CHÂSSIS SUPÉRIEUR	1
3		FRONT FACING RIGHT LEG PATTE AVANT DROITE	1
4		FRONT FACING LEFT LEG PATTE AVANT GAUCHE	1
5		BACK PANEL PANNEAU ARRIÈRE	1

LISTE DES PIÈCES
PARTS LIST

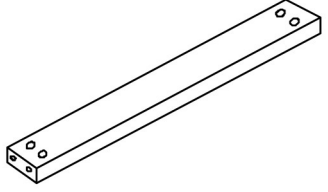
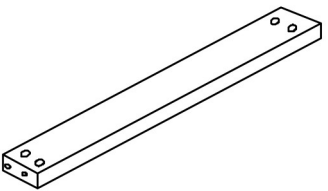
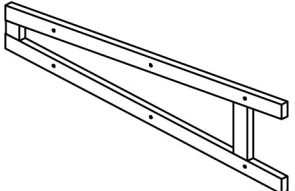
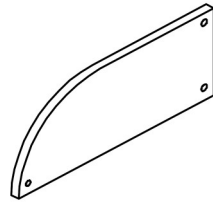
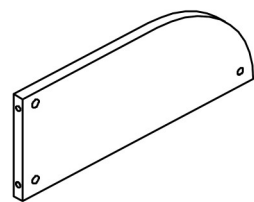
PIÈCE / PART #	IMAGE	DESCRIPTION	QTY / QTÉ
6		BOTTOM STRETCHER CHÂSSIS DU BAS	1
7		BOTTOM STRETCHER CHÂSSIS DU BAS	1
8		LEG PATTE	1
9		TOP SHELF ÉTAGÈRE SUPÉRIEURE	1
10		TOP SHELF ÉTAGÈRE SUPÉRIEURE	1

LISTE DES PIÈCES
PARTS LIST

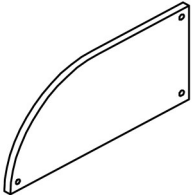
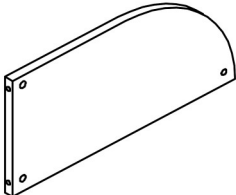
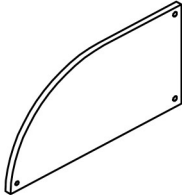
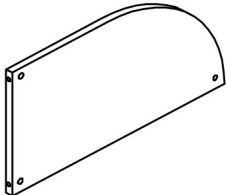
PIÈCE / PART #	IMAGE	DESCRIPTION	QTY / QTÉ
11		<p align="center">SHELF PANEL PANNEAU DE TABLETTE</p>	1
12		<p align="center">SHELF PANEL PANNEAU DE TABLETTE</p>	1
13		<p align="center">BOTTOM SHELF ÉTAGÈRE DU BAS</p>	1
14		<p align="center">BOTTOM SHELF ÉTAGÈRE DU BAS</p>	1

LISTE DES PIÈCES DE MONTAGE
HARDWARE LIST

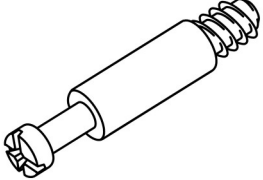
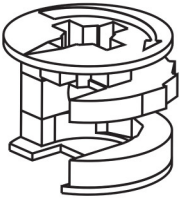
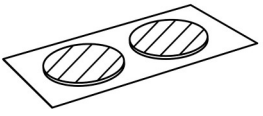
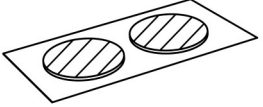
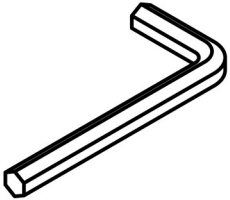
PIÈCE / PART #	IMAGE	DESCRIPTION	QTY / QTÉ
A		CAM LOCK SCREW - 1 1/8" VIS CAM LOCK - 1 1/8"	20
B		CAM LOCK CONNECTOR - Ø5/8" ÉCROU CAM LOCK - Ø5/8"	20
C		FINISHING STICKER - Ø3/4" COLLANT DE FINITION - Ø3/4"	8
D		FINISHING STICKER - Ø1/2" COLLANT DE FINITION - Ø1/2"	4
E		HEX KEY CLÉ HEXAGONALE	1

LISTE DES PIÈCES DE MONTAGE
HARDWARE LIST

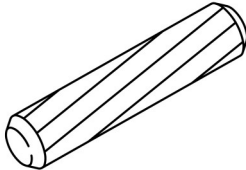
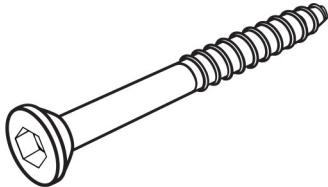
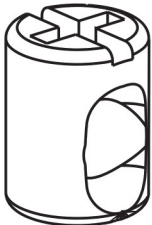
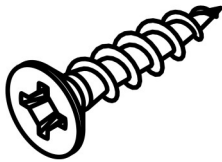
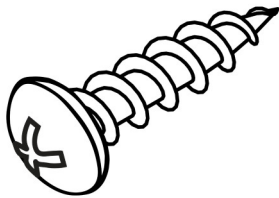
PIÈCE / PART #	IMAGE	DESCRIPTION	QTY / QTÉ
F		WOOD DOWEL - Ø3/8" X 1" GOUJON DE BOIS - Ø3/8" X 1"	10
G		ASSEMBLING SCREW - Ø1/4" X 2 5/8" VIS D'ASSEMBLAGE - Ø1/4" X 2 5/8"	6
H		BARREL NUT - Ø1/4" X 1/2" ÉCROU DE CANON - Ø1/4" X 1/2"	6
I		ASSEMBLING SCREW - Ø1/8" X 1 1/2" VIS D'ASSEMBLAGE - Ø1/8" X 1 1/2"	12
J		ASSEMBLING SCREW - Ø1/8" X 1" VIS D'ASSEMBLAGE - Ø1/8" X 1"	1

LISTE DES PIÈCES DE MONTAGE
HARDWARE LIST

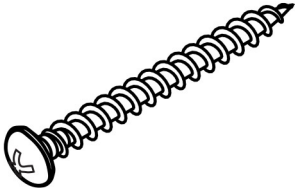
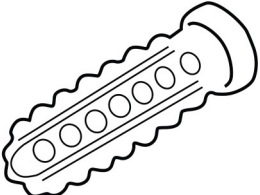
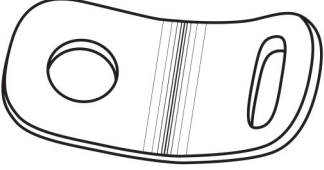
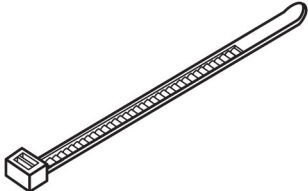
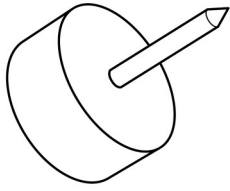
PIÈCE / PART #	IMAGE	DESCRIPTION	QTY / QTÉ
K		ASSEMBLING SCREW - Ø1/8" X 1 1/2" VIS D'ASSEMBLAGE - Ø1/8" X 1 1/2"	1
L		ANCHOR - Ø3/8" X 1 1/2" ANCRE - Ø3/8" X 1 1/2"	1
M		METAL BRACKET - 1/2" X 1/2" SUPPORT DE MÉTAL - 1/2" X 1/2"	2
N		ZIP TIE - 7 3/4" X 1/8" ATTACHE AUTOBLOQUANTE - 7 3/4" X 1/8"	1
O		FLOOR PROTECTOR - Ø5/8" PROTECTEUR DE PLANCHER - Ø5/8"	5

LISTE DES PIÈCES DE MONTAGE
HARDWARE LIST

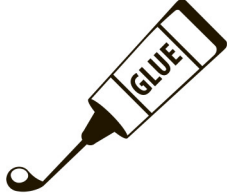
PIÈCE / PART #	IMAGE	DESCRIPTION	QTY / QTÉ
P		GLUE - 10G COLLE - 10G	1

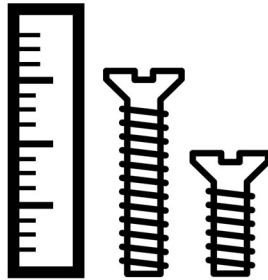

OUTIL DE VÉRIFICATION DE DIMENSIONS DES PIÈCES
HARDWARE DIMENSIONS VERIFICATION TOOL

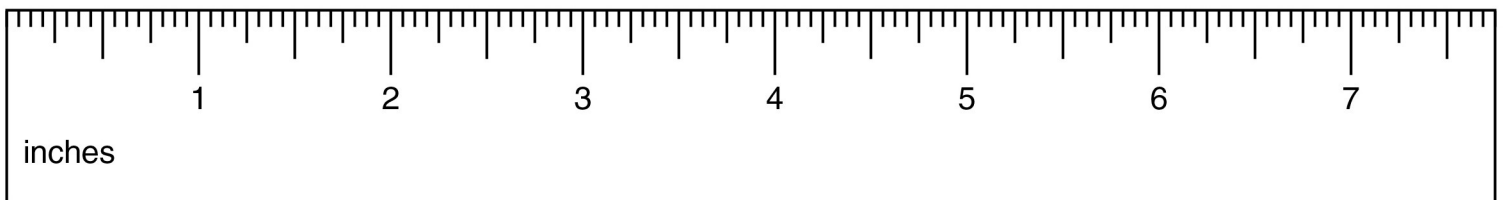

ÉTAPE / STEP 1

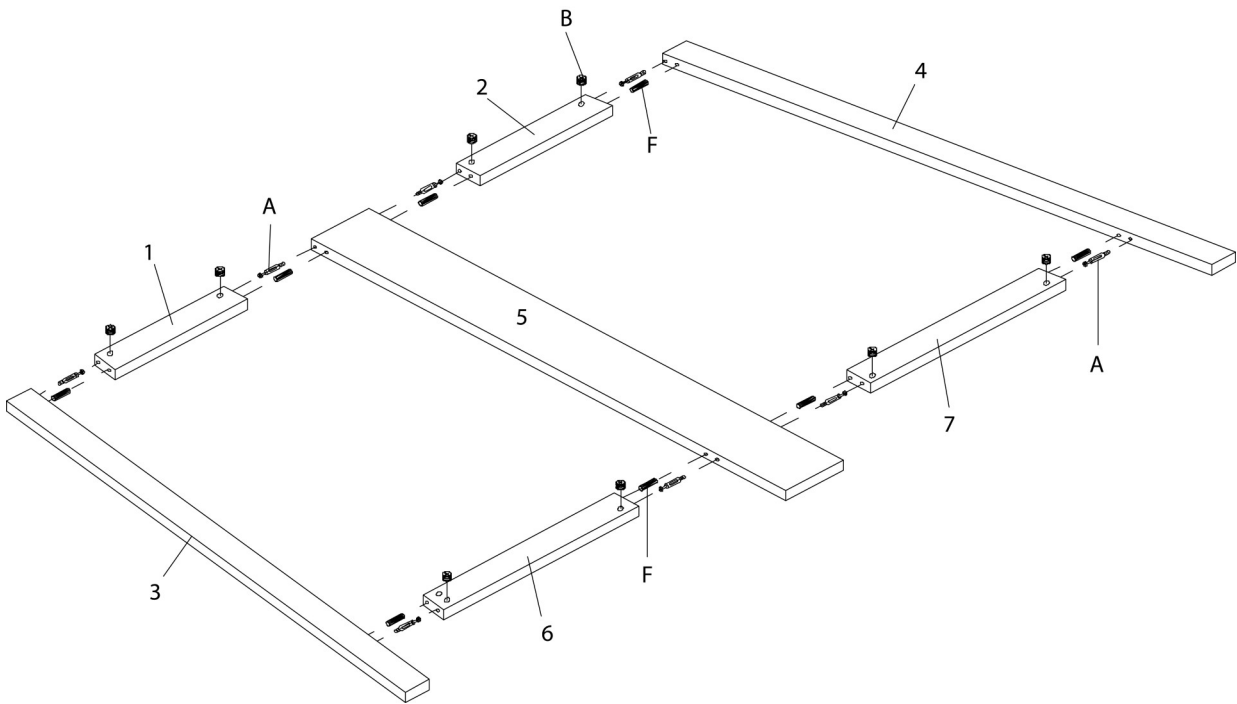

ÉTAPE / STEP 2

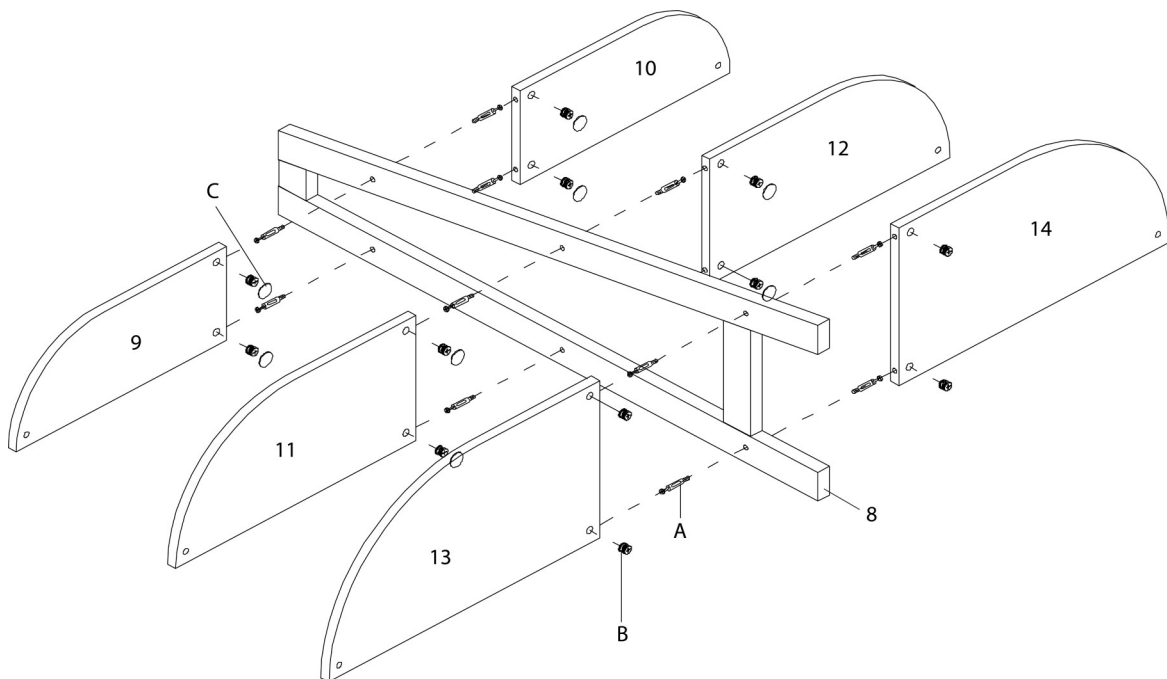

ÉTAPE / STEP 3

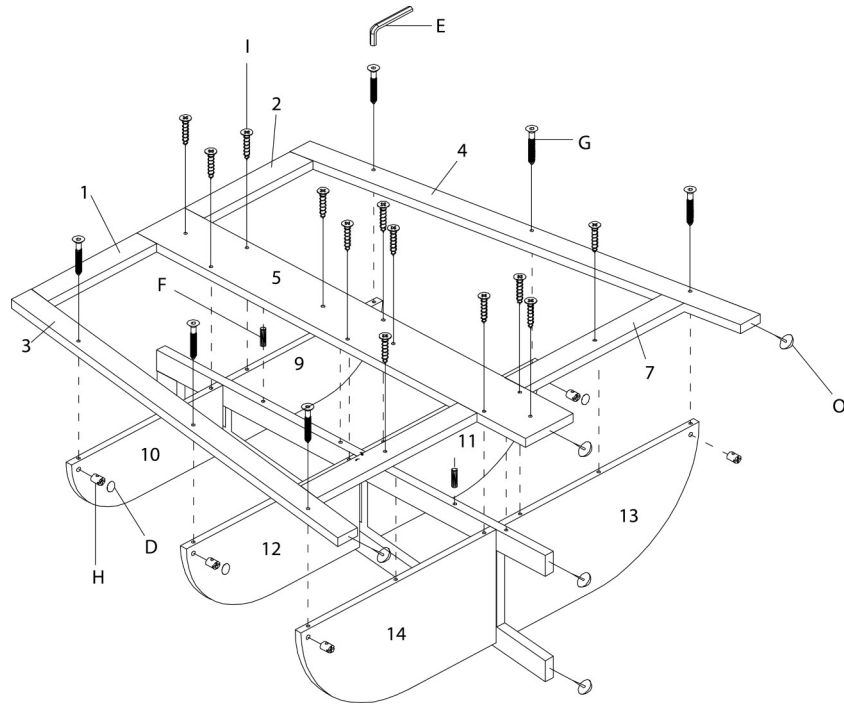

ÉTAPE / STEP 4

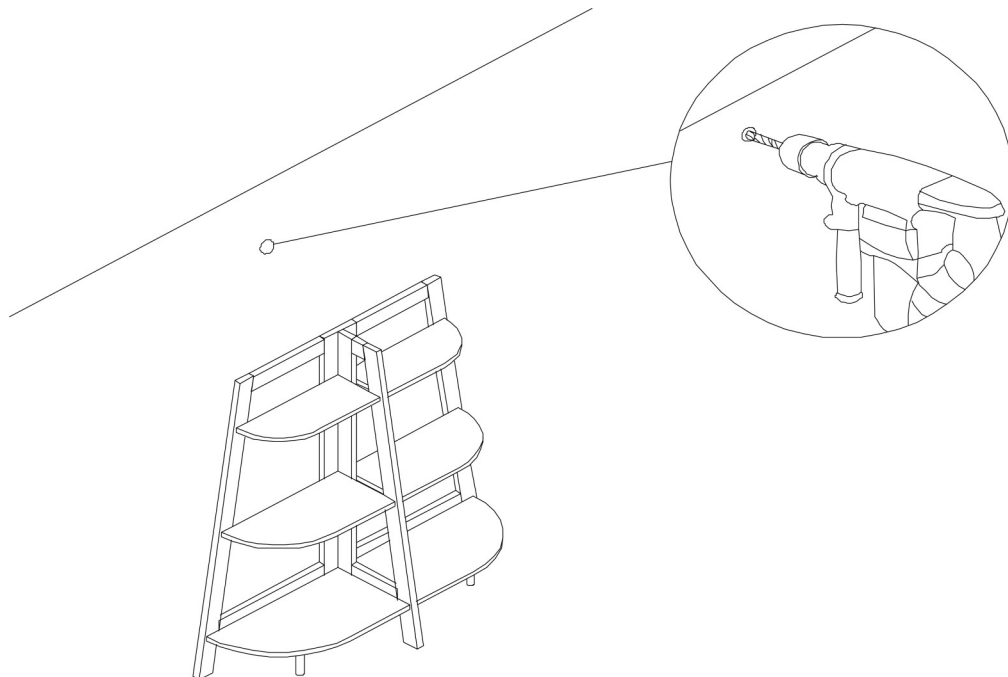

ÉTAPE / STEP 5

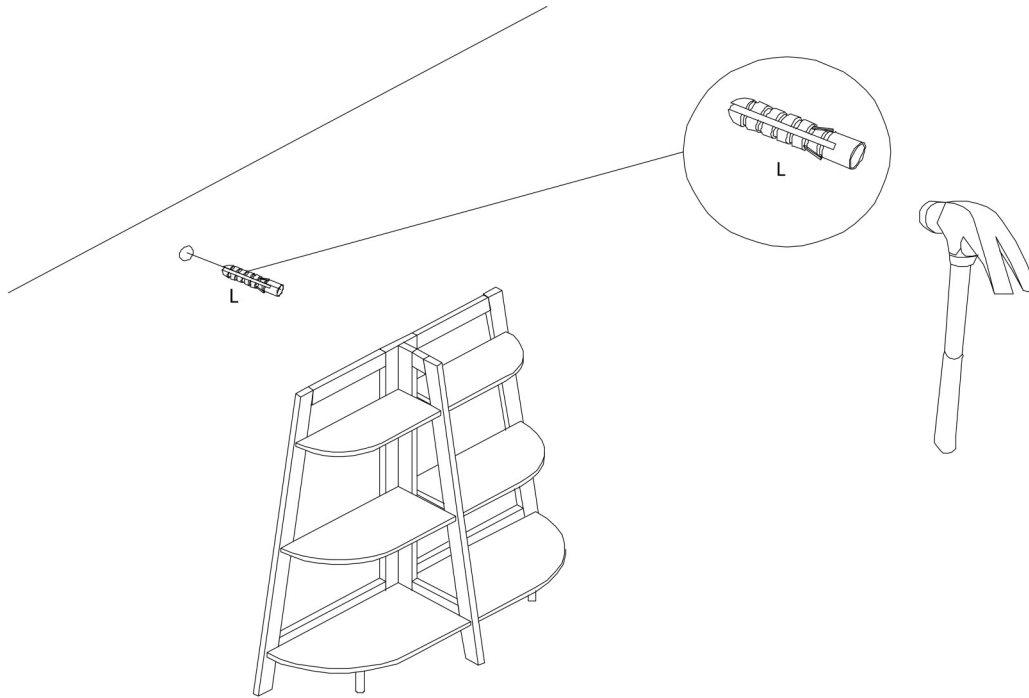

ÉTAPE / STEP 6

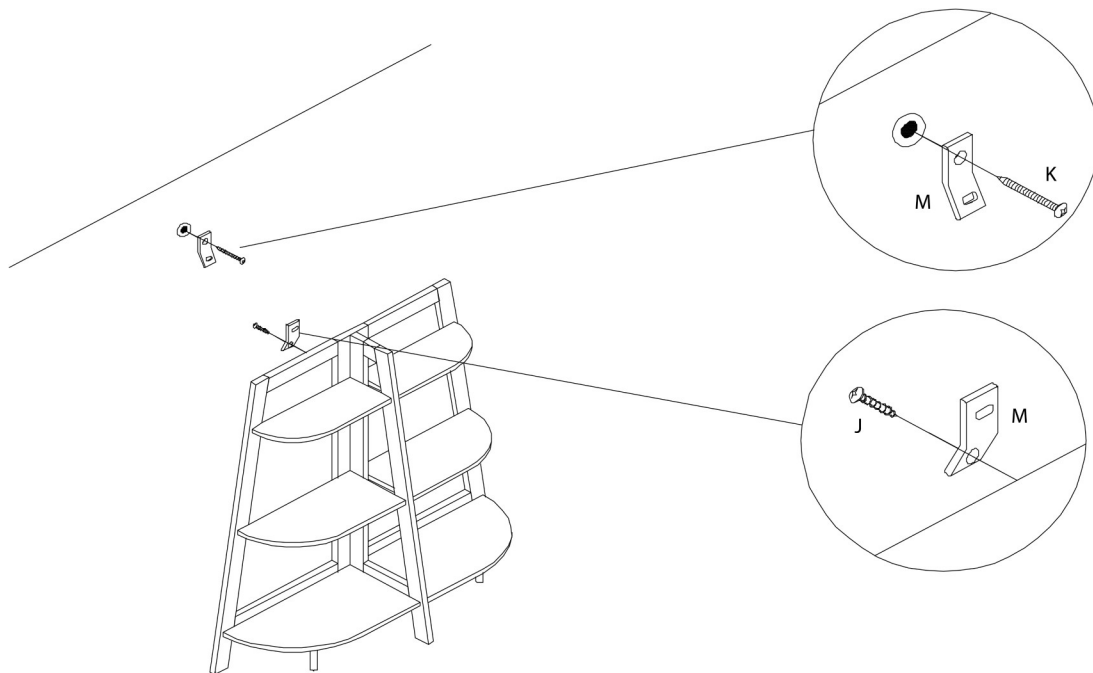

ÉTAPE / STEP 7

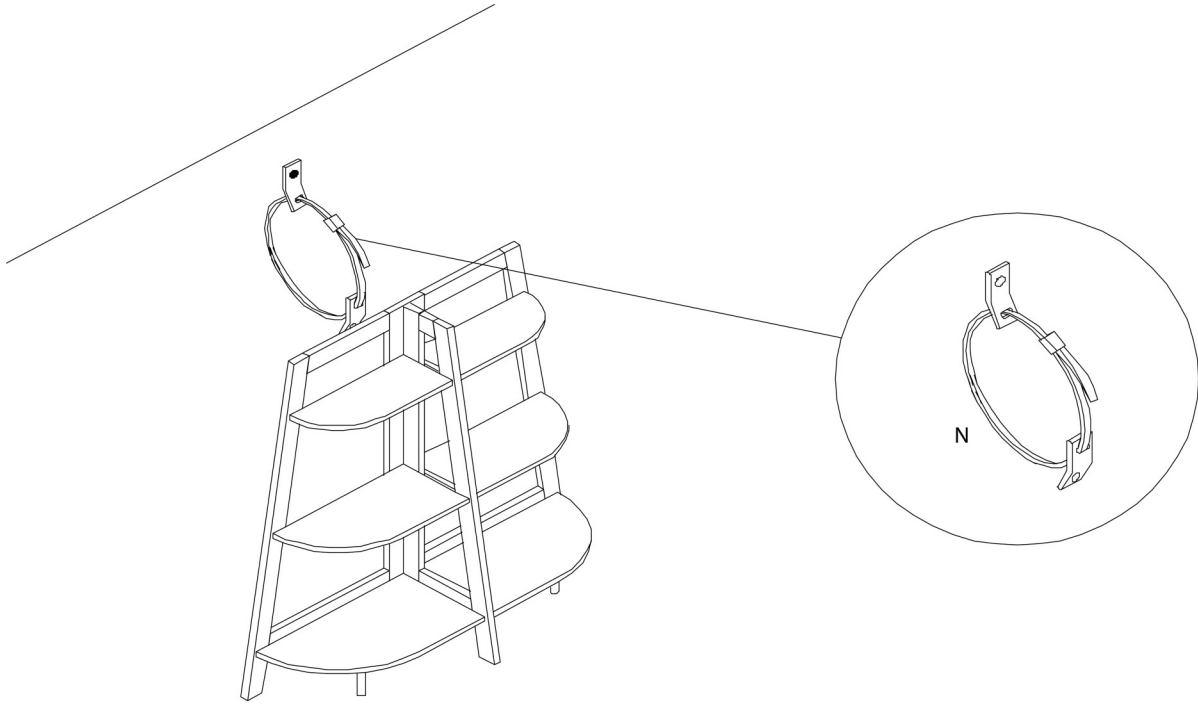

ÉTAPE / STEP 8

