



A&E Bath and Shower
 service@aebath.com
 7300 Sherbrooke St W
 Montreal, QC H4B 1R7
 (514) 482 - 5403
 (1 - 888 - 232 - 2845)

Model / Modèle: SD-08-3648-BLK
Shower Kit / Kit de Douche

Technical Information
Informations Techniques

Glass thickness
 Épaisseur du verre
5/16 in (8mm)

Opening width
 Largeur d'ouverture
24 - 7/16in

Wall to wall distance
 Distance mur à mur
46 ± 1/4in

Fixed panel size
 Taille du panneau fixe
15-5/8(W) x 5/16(T) x 74-5/8(H) in

Door panel size
 Taille du panneau de porte
28(W) x 5/16(T) x 73(H) in

Return panel size
 Taille du panneau de retour
33(W) x 5/16(T) x 74-7/8(H) in

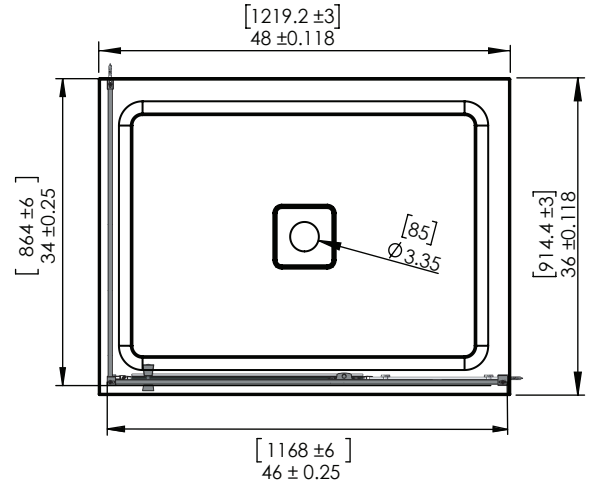

TOP VIEW VUE DU HAUT

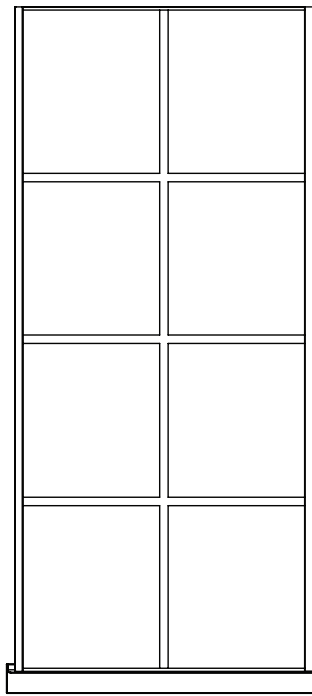

SIDE VIEW VUE DE CÔTÉ

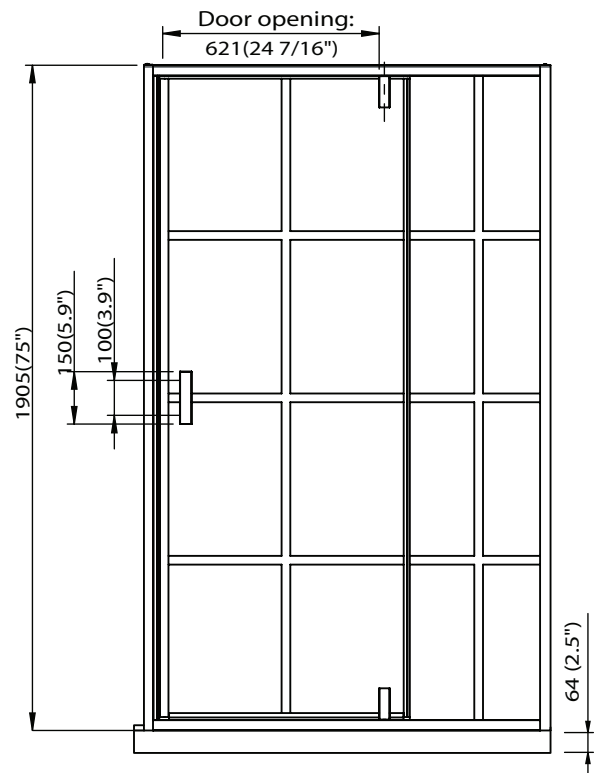

FRONT VIEW VUE DE FACE



Compliance Certifications:
Certifications de compliance:

ANSI Z97.1-2015 tempered glass
 cUPC certified shower base

* Dimensions can vary ± 1/4" (6mm) / Les dimensions peuvent varier de ± 1/4" (6mm)

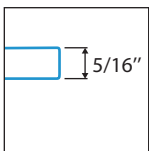

5/16in(8mm) Clear
 Tempered Glass
 5/16in(8mm) Verre
 trempé clair

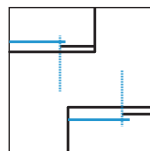

Reversible
 Installation
 Installation
 réversible

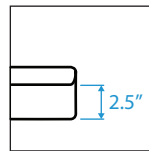

2.5in Low Threshold
 Acrylic Base
 2.5in Seuil bas
 Base acrylique

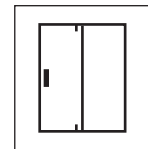

Stainless Steel frame
 Cadre en acier
 inoxydable

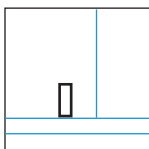

Pivoting Shower
 Door
 Porte de douche
 pivot