

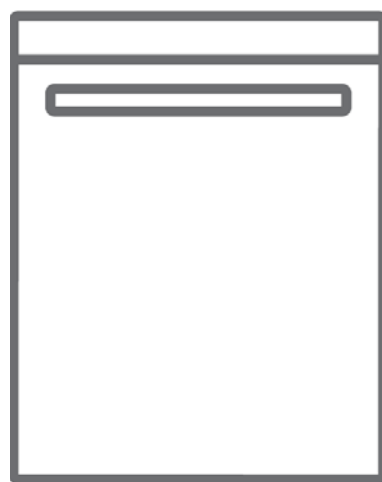

EN Dishwasher / User Manual



STU1822





# CONTENTS

<b>1 IMPORTANT SAFETY INSTRUCTIONS .....</b>	<b>5</b>
<b>2 INSTALLATION .....</b>	<b>10</b>
<b>3 TECHNICAL SPECIFICATIONS .....</b>	<b>12</b>
<b>4 BEFORE USING THE APPLIANCE .....</b>	<b>13</b>
<b>5 LOADING YOUR DISHWASHER.....</b>	<b>15</b>
<b>6 PROGRAMS AND OPTIONS TABLE.....</b>	<b>21</b>
<b>7 THE CONTROL PANEL.....</b>	<b>23</b>
<b>8 MAINTENANCE AND CLEANING.....</b>	<b>28</b>
<b>9 TROUBLESHOOTING .....</b>	<b>32</b>
<b>10 PRACTICAL INFORMATION .....</b>	<b>35</b>

**Thank you for choosing this product.**

This user manual contains important information on safety and instructions intended to assist you in the operation and maintenance of your appliance.

Please take the time to read this user manual before using your appliance and keep this book for future reference.

Icon	Type	Meaning
	<b>WARNING</b>	Serious injury or death risk
	<b>RISK OF ELECTRIC SHOCK</b>	Dangerous voltage risk
	<b>FIRE</b>	Warning; Risk of fire / flammable materials
	<b>CAUTION</b>	Injury or property damage risk
	<b>IMPORTANT / NOTE</b>	Operating the system correctly

## INTRODUCTION

Please read this user manual and particularly the safety instructions completely and carefully. They will save you time and effort and help to ensure optimum dishwasher performance.

Be sure to observe all listed warnings and cautions. Look particularly for the icons with exclamation marks inside. The information icon will also provide important references.

 **WARNING:** Indicates a potentially hazardous situation which, if not avoided, could result in death or serious injury.

 **CAUTION:** Indicates a potentially hazardous situation which, if not avoided, may result in injury. It may also be used to alert against unsafe practices.

 **NOTICE:** Indicates a potentially hazardous situation which, if not avoided, may result in damage to the dishwasher, the tableware, the equipment or the environment.

## 1 IMPORTANT SAFETY INSTRUCTIONS

**WARNING:** When using the dishwasher, follow basic precautions. Read all instructions before using the dishwasher! Save these operating instructions and pass them on to any future user.

- Use the dishwasher only for its intended purpose as described in this user manual. This appliance is intended for normal household use only. Do not change the specification of the appliance. **The manufacturer disclaims responsibility for damage or injury caused by improper use of this appliance.**
- The information in this user manual must be followed to minimize the risk of fire or explosion and to prevent property damage, personal injury or loss of life
- Use only detergents or wetting agents recommended for use in a dishwasher and keep them out of the reach of children.
- When loading items to be washed.
  - 1) Locate sharp items so that they are not likely to damage the door seal, and.
  - 2) Load sharp knives with the handles up to reduce the risk of type injuries.
- Do not wash plastic items unless they are marked “dishwasher safe” or the equivalent. For plastic items not so marked, check the manufacturer’s recommendations.
- Do not touch the HEATING ELEMENT during or immediately after use.

- Do not operate your dishwasher unless all ENCLOSURE panels are properly in place.
- Do not tamper with controls.
- Do not abuse, sit on, or stand on the door or dish rack of the dishwasher.
- The cup racks are designed to support cups, glasses and kitchen utensils. When the cup racks are in the dishwasher do not lean on or use the cup racks to support your body weight.
- This appliance must be grounded. In the event of a malfunction or breakdown, grounding will reduce the risk of electric shock by providing a path of least resistance for electric current. This appliance is equipped with a cord having an equipmentgrounding conductor and a grounding plug. The plug must be plugged into an appropriate outlet that is installed and grounded in accordance with all local codes and ordinances.

** WARNING:**

Improper connection of the equipmentgrounding conductor can result in a risk of electric shock. Check with a qualified electrician or service representative if you are in doubt whether the appliance is properly grounded. Do not modify the plug provided with the appliance, if it will not fit the outlet, have a proper outlet installed by a qualified electrician.

- Some dishwasher detergents are strongly alkaline. They can be extremely dangerous if swallowed. Avoid contact with the skin and eyes and keep children and

infirm persons away from the dishwasher when the door is open.

Consult a doctor immediately if detergent has been swallowed or inhaled.

- Do not remove the dishes from the appliance until the program is complete. Some detergent may remain on the dishes.
- Check that the detergent dispenser is empty after the completion of each wash program.
- Do not drink and play with the water in the appliance. harmful residues could be present.
- To reduce the risk of injury, do not allow children to play in or on a dishwasher.
- When children become old enough to operate the appliance, it is the responsibility of the parents/legal guardians to ensure the children are instructed in safe practices by qualified persons.
- Do not leave the appliance with the open door unattended to avoid stepping accidentally onto it.

**⚠ WARNING:** Before any maintenance operation, deactivate the appliance and disconnect the mains plug from the socket.

- Do not use high pressure water sprays and/or steam to clean the appliance.
- Ensure that there are no visible water leaks during and after the first use of the appliance.

- To avoid floor damage and possible mold growth, do not allow wet areas to remain around or under the dishwasher.
- To avoid dishwasher damage, do not allow water to remain in your dishwasher systems through extended periods of freezing.

**RISK OF INJURY:** To avoid risk of injury, always use caution when opening the door during or following a wash cycle as hot water or steam may escape.

- Do not store or use flammable liquids or vapors in the area of the dishwasher, near or on the appliance.
- Under certain conditions, hydrogen gas may be produced in a hotwater system that has not been used for two weeks or more. **HYDROGEN GAS IS EXPLOSIVE.** If the hot-water system has not been used for such a period, before using the dishwasher turn on all hot-water faucets and let the water flow from each for several minutes. This will release any accumulated hydrogen gas. As the gas is flammable, do not smoke or use an open flame during this time.
- Please check the water supply line periodically. It is susceptible to breakage. It becomes less flexible as time goes by. Replace it immediately when it is torn, cut, swollen or there is water leakage.

## **RECYCLING**

Remove the door to the washing compartment when removing an old dishwasher from service or discarding it. Ensure that the appliance presents no danger to children while being stored for disposal. Before disposing the dishwasher:

- Disconnect the appliance from the mains supply.
- Cut off the mains cable and discard it.
- Remove the door catch to prevent children and pets to get closed in the appliance

Old appliances may contain materials that can be recycled. Please contact your local recycling authority about the possibility of recycling these materials.

Please check the water supply line periodically. It is susceptible to breakage. It becomes less flexible as time goes by. Replace it immediately when it is torn, cut, swollen or there is water leakage.

Please keep the dishwasher package out of the reach of children after unpacking it.

### **WARNING!:**

**Risk of injury or suffocation!** Ensure that any plastic wrappings, bags, small pieces etc. are disposed of safely and kept out of the reach of children.

## **SAVE THESE INSTRUCTIONS**

## 2 INSTALLATION

**⚠ WARNING:** When installing the dishwasher, follow basic precautions, including the following: Please check the standards and local codes for placement of machine.

- Installation, maintenance and repair should be performed by a qualified installer. Work by unqualified persons could be dangerous and may void the warranty.
- Do not operate the appliance if damaged, malfunctioning, partially disassembled or if it has missing or broken parts.
- Before installation or service, disconnect the power supply to the work area by unplugging the unit, “tripping” the circuit breaker or removing the fuse.
- Only connect the dishwasher to the power supply when all installation and plumbing work is complete.
- Never connect the ground wire to gas lines, or hot water pipes, plumbing lines.
- Do not install or store the dishwasher where it can be exposed to below freezing temperatures or exposed to weather.
- Dishwasher must be secured to adjacent cabinetry using the brackets provided. Failure to do this may cause damage to property or bodily injury.
- Connect to a properly rated, protected and sized power supply circuit to avoid electrical overload. The dishwasher is designed for an electrical supply

of 120 V (volts), 60 Hz (hertz), AC, connected to a dishwasher-dedicated, properly grounded electrical circuit with a fuse or breakers rated for 15 amperes. Electrical supply conductors shall be a minimum of # 16 AWG copper wire rated at 75 °C (167 °F) or higher. These requirements must be met to prevent injury and machine damage. Consult a qualified electrician if in doubt.

- Do not use any extension cord or portable outlet device to connect the dishwasher to a power supply.

**⚠ WARNING:** Danger of suffocation! Ensure that any plastic wrap-pings, bags, small pieces etc. are disposed of safely and kept out of the reach of children.

### 3 TECHNICAL SPECIFICATIONS

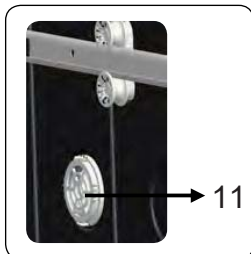
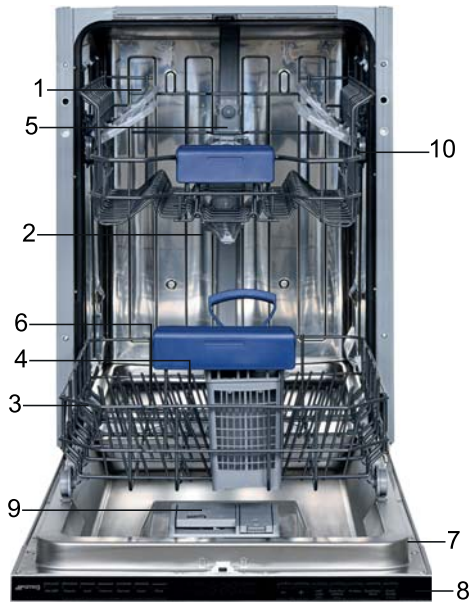

#### General Appearance

1. Upper Basket with Racks
2. Upper Spray Arm
3. Lower Basket
4. Lower Spray Arm
5. Top Nozzle
6. Filters
7. Rating Plate Location
8. Control Panel
9. Detergent and Rinse-Aid Dispenser
10. Upper Basket Track Latch
11. Drying Unit: This system provides better drying performance for the dishes.

#### Technical Specifications

Permissible water pressure	4.35 - 145 psi (0.3 - 10 bars)
Electrical connection	120 V (volts), 12 A (amps), 60Hz (hertz)
Total power	1400 (W)
Heater power	1100 (W)

**NOTICE:** Because we continually strive to improve our products, we may change our specifications and design without prior notice. This device corresponds to the following directives: UL 749 Household Dishwasher directive.

## 4 BEFORE USING THE APPLIANCE

### Preparing your dishwasher for first use

- Make sure the electricity and supply water specifications match the values indicated in the installation instructions for the machine.
- Remove all packaging material inside the machine.
- Fill the rinse aid compartment.

### Detergent usage

Only use detergents specifically designed for domestic dishwashers. Keep your detergents in cool, dry places out of reach of children.

Add the proper detergent for the selected program to ensure the best performance. The amount of detergent needed depends on the cycle, load size, and soil level of dishes.

Do not fill detergent into the detergent compartment more than required; otherwise you can see whitish streaks or bluish layers on glass and dishes and may cause glass corrosion. Continued use of too much detergent may cause machine damage.

Using little detergent can result in poor cleaning and you can see whitish streaks in hard water.

See the detergent manufacturer's instructions for a further information.

### Filling the detergent

Push the latch to open the dispenser and pour in the detergent.

Close the lid and press it until it locks in place. The dispenser should be refilled just before the start of each programme. If the dishes are heavily soiled, place additional detergent in the pre-wash detergent chamber.

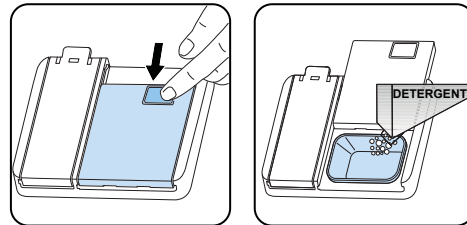

### Using combined detergents

These products should be used according to the manufacturer's instructions.

Never put combined detergents into the interior section or the cutlery basket.

Combined detergents contain not only the detergent but also rinse-aid, salt replacement substances and additional components depending on the combination.

We recommend you do not use combined detergents in short programmes.

Please use powder detergents in such programmes.

If you encounter problems when using combined detergents, please contact the detergent manufacturer.

When you stop using combined detergents, make sure that water hardness and rinse aid settings are set to the correct level.

### Rinse-aid usage

The rinse aid helps to dry the dishes without streaks and stains. Rinse-aid is required for stain-free utensils and clear glasses. The rinse aid is automatically released during the hot rinse phase. If rinse aid dosage setting set too low, whitish stains remains on dishes and dishes do not dry and washed clean. If rinse aid dosage setting set too height, you can see bluish layers on glass and dishes.

### Filling the rinse-aid and setting

To fill the rinse aid compartment, open the rinse-aid compartment cap. Fill the compartment with rinse aid to the MAX level and then close the cap. Be careful not to overfill the rinse aid compartment and wipe up any spills.

### In order to change the rinse aid level, follow the below steps

- Turn on the machine and press Menu button for 3 seconds. Water hardness level is seen first. ("SL1" is the factory setting)
- Press Delay(+) button to pass Rinse aid setting. ("r:4" is the factory setting)
- Rinse aid follows water hardness setting.
- Then, press Select button and the level of Rinse aid (e.g. "r:4") blinks.
- Change the level by pressing the Delay buttons.
- Press Select button to save desired level and the new level of Rinse aid will illuminate constantly.
- Turn off the machine to exit from the setting.

The factory setting is "4".

If the dishes are not drying properly or are spotted, increase the level. If blue stains form on your dishes, decrease the level.

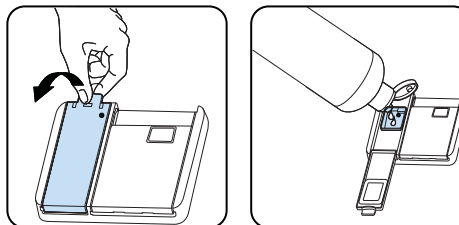

Level	Brightener Dose	Indicator
1	Rinse-aid not dispensed	r:1 is shown on the display.
2	1 dose is dispensed	r:2 is shown on the display.
3	2 doses are dispensed	r:3 is shown on the display.
4	3 doses are dispensed	r:4 is shown on the display.
5	4 doses are dispensed	r:5 is shown on the display.

## 5 LOADING YOUR DISHWASHER

If you properly place your dishes into the machine, you will be using it in the best way in terms of energy consumption, washing and drying performance.

You can load into the lower basket such round and deep items as pots with long handles, pot lids, plates, salad plates, cutlery sets. The upper basket has been designed for dessert plates, salad bowls, cups and glasses. When placing long stem glasses and goblets, lean them against the basket edge, rack or glass supporter wire and not against other items. Do not lean long glasses against one another or they cannot remain steady and may receive damage. It is more appropriate to locate the thin narrow parts into the middle sections of baskets. You can place spoons among the other cutlery sets in order to prevent them from sticking to one another.

You are recommended to use the cutlery grid in order to obtain the best result. To avoid any possible injuries, always place such long-handle and sharp-pointed dishes as serving fork, bread knife etc. with their sharp points facing down or horizontally on the baskets.

 **WARNING:** Place your dishes into your machine in a way that they will not prevent the upper and lower spray arms from spinning.

 **NOTE:** Place all large and very dirty items in the lower rack.

 **WARNING:** Do not put in the appliance items that can absorb water (sponges, household cloths).

 **NOTE:** Place all containers such as cups, glasses and pots into the dishwasher with the opening facing downwards (so that no water can collect).

 **NOTE:** Dishes and cutlery should not be placed above each other.

 **NOTE:** Do not overload your dishwasher and pay attention to manufacturer instructions regarding dishes which are appropriate for use in a dishwasher. Only with suitable dishes (mentioned in section 5) will you obtain optimal washing results with a sensible use of energy.

High temperature water and dishwasher detergent may form a chemical synthesis that can damage certain items.

 **WARNING:** Be careful when loading and unloading sharp items. Load sharp knives with the handles up to reduce the risk of personal injury.

Follow the below steps before loading dishwasher.

1. Open the door.
2. Remove coarse food leftovers from tableware.
3. Load the dishwasher.

 **NOTE:** While the appliance is running if you open the door all functions are automatically interrupted. Once the door is closed functions will continue to work.

### Upper Rack

Load the upper rack with dessert plates, cups, glasses etc.

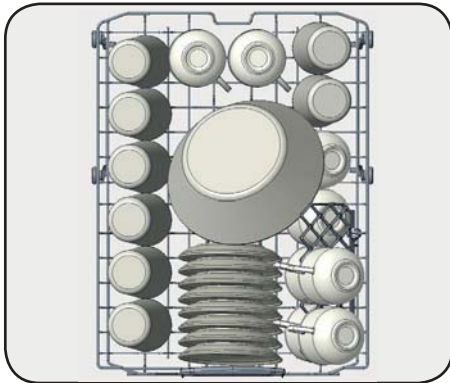

Top rack load pattern for 8 place settings.

### Lower Rack

You can load into the lower basket such round and deep items as pots with long handles, pot lids, plates, salad plates, cutlery sets. The lower rack should not be used for small items such as cups, wine glasses.

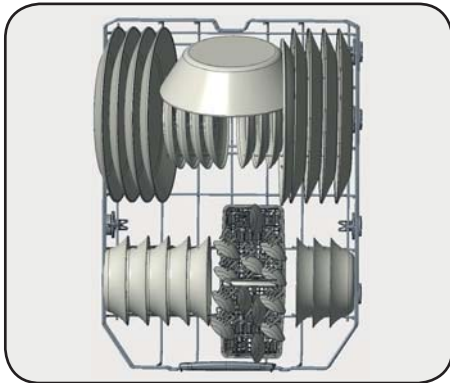

Bottom rack load patterns for 8 place settings.

 **NOTE:** Place all large and very dirty items in the lower rack.

 **WARNING:** Large knives and other utensils with sharp tips and edges must be placed horizontally into the upper rack due to risk of injury. Other smaller knives and sharp utensils should be placed with sharp side down in the cutlery basket.

 **NOTE:** Make sure that large items do not interfere with the rotation of the spray arms, and do not prevent the detergent dispenser from opening.

**Loading cutlery basket  
( Model Depending )**

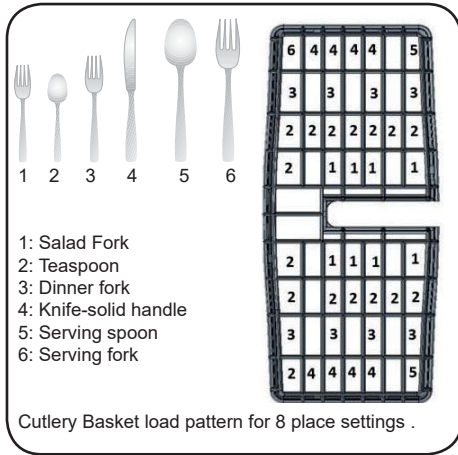

**WARNING:** Sharp cutlery may have shifted position during the wash operation and can be also wet and slippery. Carefully remove them to prevent injury.

**NOTE:** Small items should therefore be placed in the cutlery tray or cutlery basket (model depending). Because small items can fall through the holders from the baskets.

**Incorrect Loads**

Incorrect loading can cause poor washing and drying performance. Please follow the manufacturer's recommendations for a good performans result.

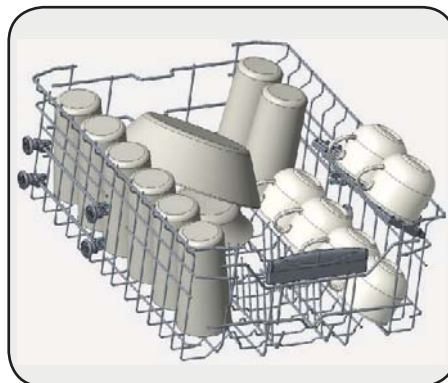
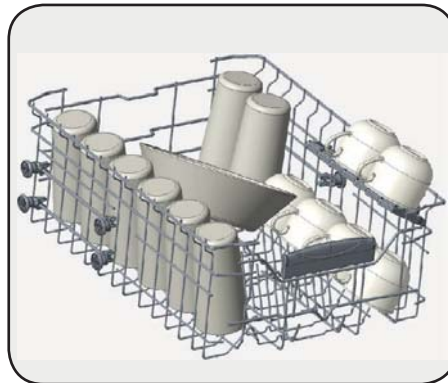
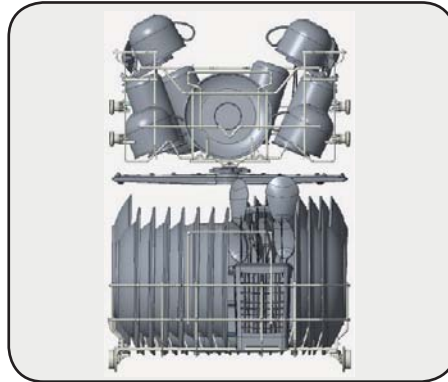

## Top Basket

### Rack with height adjustment

These racks are designed to increase the capacity of top basket. You can place your cups and glasses on these racks. Thanks to adjustable feature of the racks, you can place glasses of different sizes under the racks.

Height adjustment plastics mounted on the basket allow racks to be in 2 different positions.

You can also place long knives, forks and spoons on these racks horizontally for them not to block the movement of spray arms.

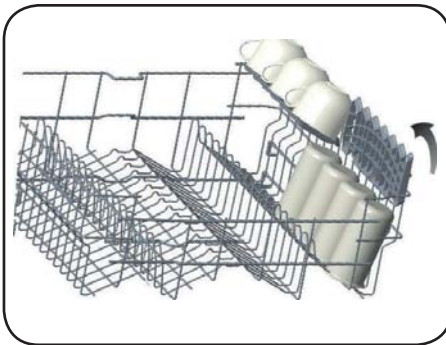
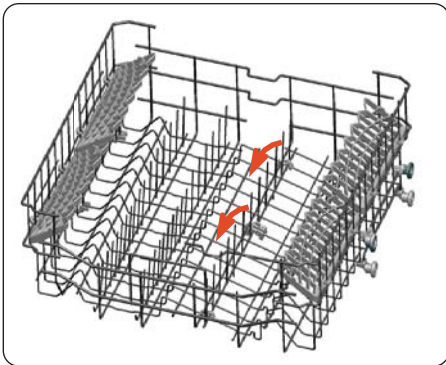

Top basket horizontal wire located on top basket allows you to place your plates and bowls where required. Also you can wash kitchenware such as pan or pot by closing the horizontal wire.

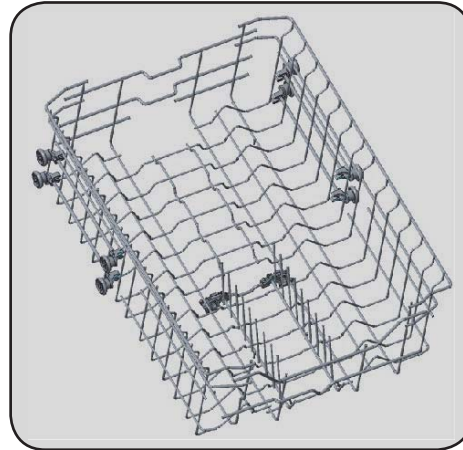

NOTICE: Bringing the wires to the horizontal position by holding them from the tips may cause them to bend. Therefore, it will be appropriate to bring the wires in the middle to horizontal or vertical position by holding them from their stems and pushing.

The basket height adjustment mechanism on the top basket of your machine is designed to let you adjust the height of your top basket upwards or downwards, without removing it from your machine when it is full, and create large spaces at the top or bottom area of your machine as needed. Basket of your machine is set to upper position in factory settings. In order to raise your basket, hold it from both sides and pull it upwards. In order to lower it, hold it from both sides again, and leave it. In loaded basket adjustment mechanism, make sure that both sides are in the same position. (up or down)



NOTICE: Make sure that both levers catch in the same height position.

**Height setting - when basket is filled (model depending)**

The upper basket includes a mechanism which enables the height of the basket to be adjusted up (1) or down (2) without having to remove the basket. Hold the basket on both sides and pull it up or push it down, ensuring both sides of the upper basket are in the same position.

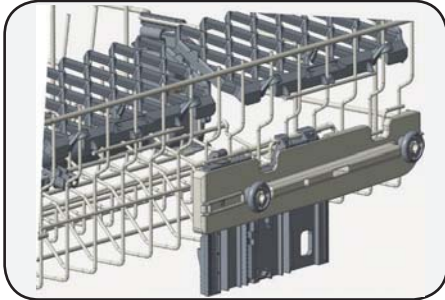
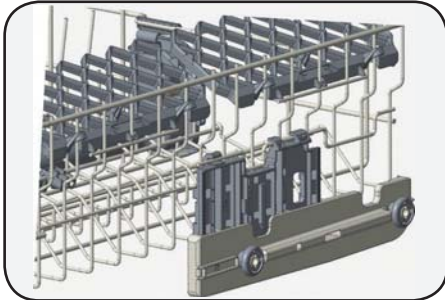
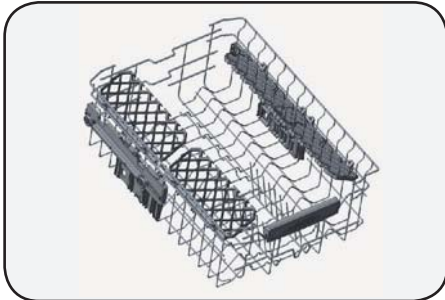

**Lower Basket Folding Racks**

Folding racks consisting of four parts that are located on the lower basket of your machine are designed in order to let you place big items easier such as pots, pans, etc. If requested, each part can be folded separately, or all of them can be folded and larger spaces can be obtained. You can use folding racks by raising them upwards, or by folding.

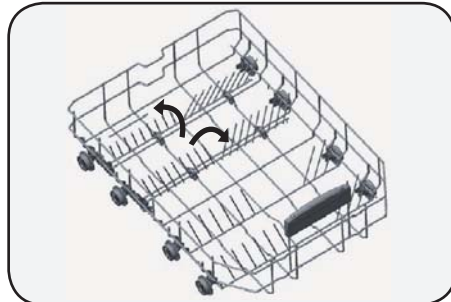
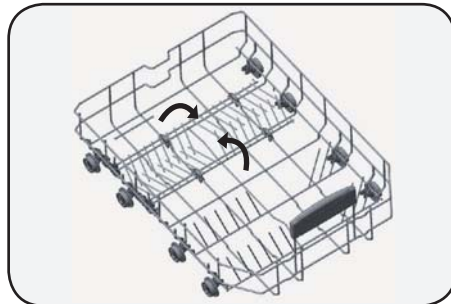

### Upper Cutlery Basket

The upper cutlery basket is designed for the placement of large and small cutlery and utensils.

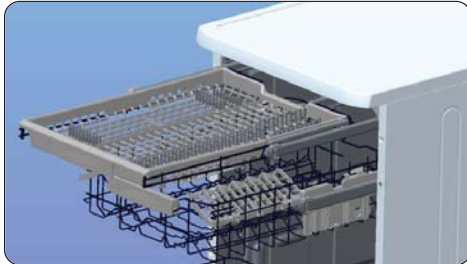

It is easily removed from the dishwasher, therefore allows ease of use when removing your items, along with the basket, after washing.

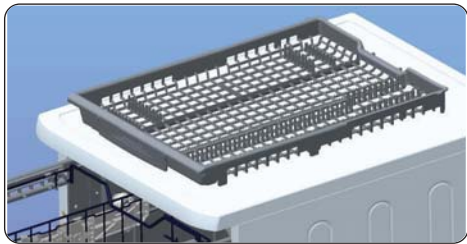



**WARNING:** Knives and other sharp objects must be placed horizontally in the cutlery basket.

## 6 PROGRAMS AND OPTIONS TABLE

Programs		Duration (min)	Descriptions
Regular	Dirty	140	Standard program for daily, regular or typical use to completely wash a load of normally soiled dishes.
	Clean	105	
Auto	Dirty	155	This program automatically adjusts the temperature and the quantity of water, the energy consumption and the program duration.
	Clean	110	
Intensive		130	Suitable for heavily soiled dishes.
Delicate		90	Suitable for lightly soiled delicate dishes.
Super		50	Suitable for normally soiled daily dishes with faster program.
Rinse		15	Suitable to rinse dishes that you plan to wash later.

Compatibility of Programs and Options		Options					
		Half Load	Sanitize	Extra Fast	Extra Dry	Hi-Temp	Silent
Programs	Regular	√	√	√	√	√	√
	Auto	√	√	√	√	√	√
	Intensive	√	√	√	√	√	√
	Delicate	√	X	√	√	X	√
	Super	√	√	X	√	√	X
	Rinse	√	X	X	X	X	X

 **NOTE:** The program duration may change according to the amount of dishes, the water temperature, the ambient temperature in the room, and any selected additional functions.

 **NOTE:** The energy-usage label is based on the “Regular” program. This program is the most efficient in terms of its combined energy and water consumption at cleaning normally soiled dishes.

- Only use powder detergent for short programs.
- Short programs do not include drying.
- To assist drying, we recommend slightly opening the door after a cycle is complete.

### **Water Temperature**

Hot water is needed for best dishwashing and drying results. Water entering dishwasher should be at least 120°F (49°C) to give satisfactory results. To check water temperature entering dishwasher:

- Turn on hot water faucet nearest dishwasher for several minutes to clear cool water from pipes.
- Hold a candy or meat thermometer in stream of water to check the temperature.
- If temperature is below 120°F (49°C), have a qualified person raise the hot water heater thermostat setting.

## 7 THE CONTROL PANEL

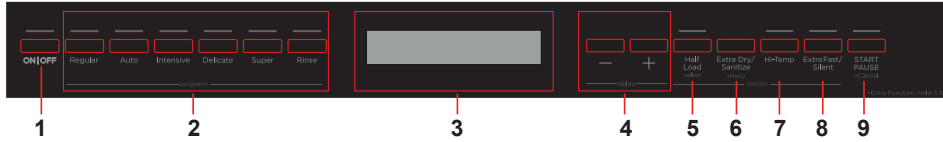

1. On/Off Button
2. Programme Buttons
3. Display
4. Delay Buttons
5. Half Load Button
6. Extra Dry/Sanitize Button
7. Hi-Temp Button
8. Extra Fast/Silent Button
9. Start/Pause Button

### 2. Programme Selection Buttons

Select a suitable program for your dishes by pressing Programme buttons. For the details of the programs refer to section Program Table.

### 3. Display

The display shows the total time of the selected programme and the remaining time during operation.

### 4. Delay Buttons

Press the Delay Buttons to delay the start time of a programme for 1 hour up to 24 hours. Pressing once to + button will delay the start time for 1 hour. Once you press it, display will show "1h" and display will show program duration and delay time alternately for 2 seconds. Continuing to press the button will increase the delay duration. Press the - button to decrease the delay duration. In order to start the selected program with delay, Start/Pause button(8) should be pressed and the door of the dishwasher must be closed within 4 seconds. If you turn off the machine after activating the delay time, the delayed time is cancelled.

### 5. Half Load Button

There is half load option with 3 modes. When you press the half load button in user interface the indicator/indicators on the screen will be on according to your mode choice. If you press the button once the upper half load basket indicator will be visual, if you press the button twice the lower half load basket indicator will visual, and if you press the button 3rd times, the upper half load basket indicator and lower half load basket indicator will be visual on the screen. After 4th press the button the indicators will be disappear. Also, if any of the half load option modes are selected, the half load button led will be on.



10. Rinse Aid Indicator
11. End Step Indicator
12. Sanitized Indicator
13. Delay Indicator
14. Extra Fast Indicator
15. Extra Dry Indicator
16. Upper Half Load Indicator
17. Lower Half Load Indicator
18. Sanitize Indicator
19. Silent Indicator
20. Programme Time Indicator

### 1. On/Off Button

Turn the machine on by pressing the On/Off button.

#### **6. Extra Dry/Sanitize Button**

Press once the Extra Dry/Sanitize button to add extra drying steps to a programme in order to obtain drier dishes. This option increases water temperature of the final rinse step and duration of the drying step.

Press twice the Extra Dry/Sanitize button to select sanitize option. This function raises the water temperature in the final rinse.

After 3rd press, functions will be unselected.

#### **7. Hi-Temp Button**

When this option is selected, both the water temperature and the washing time are increased. Hi-Temp led will be on.

#### **8. Extra Fast/Silent Button**

Press once the Extra Fast/Silent button to select the Extra Fast function. This function decreases the duration of a programme, providing more economical water usage.

Press twice the Extra Fast/Silent button to select the Silent function for a more sensitive and silent washing operation. This option reduces the sound pressure level of the washing.

After 3rd press, functions will be unselected.

#### **9. Start/Pause Button**

Open the door of your machine. Select the program and options. Press Start/Pause button. Close the door within 4 seconds, the program will start. If 4 seconds is exceeded and the door is closed, program will not start.

The total time can also change while the program is running depending on the ambient temperature where your machine is installed, temperature of the supply water and amount of the dishes.

If the door is opened while the machine is running, the machine will switch to the standby mode. Press Start/Pause button and close the machine door within 4 seconds, then the program will resume.

#### **10. Rinse Aid Indicator**

When the rinse aid level is low, the rinse aid indicator turns on and you should fill the rinse aid chamber.

#### **11. End Step Indicator**

When the program is completed, end step indicator will be on and the buzzer will be activated. Buzzer sounds 5 times each at 5 minutes intervals (in 0, 5, 10 and 15th minutes) in total 4 different times at the end of the program.

#### **12. Sanitized Indicator**

At the end of a successful sanitization, Sanitized indicator will illuminate at the end of the program.

#### **13. Delay Indicator**

When programme is started with delay, the Delay Indicator will be on.

#### **14. Extra Fast Indicator**

If the Extra Fast option is selected, extra fast indicator will illuminate.

#### **15. Extra Dry Indicator**

If Extra Drying option is selected, extra heating and drying steps will be added into the selected program, so you can ensure that your dishes will be extracted dryer. Extra dry indicator will illuminate.

#### **16. Upper Half Load Indicator**

If you have dishes only in the upper basket, select the half load upper basket option. If it is selected, half load upper basket indicator will illuminate.

#### **17. Lower Half Load Indicator**

If you have dishes only in the lower basket, select the half load lower basket option. If it is selected, half load lower basket indicator will illuminate.

**Note:** If you have dishes both of in the upper and lower basket , select the half load upper basket and half load lower basket option together. If it is selected, upper half load basket indicator and lower half load basket indicator together will illuminate.

#### 18. Sanitize Indicator

Sanitize function raises the water temperature in the final rinse. Sanitize indicator will illuminate.

#### 19. Silent Indicator

The Silent option is selected, silent indicator will illuminate.

#### 20. Programme Time Indicator

Programme duration can be monitored via Programme Time Indicator.



#### Changing a Programme

Follow the steps below to change a programme while in operation.

Open the door and press the Start/Pause button(9). Choose a new programme by pressing Programme buttons(2). After programme selection, press the Start/Pause button(9). After closing the door within 4 seconds, the newly selected programme will resume the course of the old programme. If 4 seconds is exceeded and the door is closed, program will not resume.

**NOTE:** Open the door slightly at first to stop a wash programme before it is complete in order to avoid water spillage.

#### Cancelling a Programme

Follow the steps below if you would like to cancel a programme while in operation.

Open the door of your machine. The selected programme will appear on the display. Press and hold the Start/Pause button(9) for 3 seconds. "0:01" will be shown on the display. Press Start/Pause button(9) and after closing the door of the machine within 4 seconds, the water discharge process will start and continue for 30 seconds. When the programme is cancelled, buzzer will sound 5 times.

#### Switching the Machine Off

"0" will be shown on the display when the selected programme is complete. Buzzer will also sound 5 times. You can then switch your machine off using the Power On/Off button. Disconnect the plug and turn off the water tap.

**NOTE:** Do not open the door before the programme is complete.

**NOTE:** If the door of the machine is opened or the power is cut off while a programme is in operation, the programme will continue when the door is closed or the power returns.

**NOTE:** If the power is cut off during the drying process, the programme will terminate. Your machine will be ready for a new programme selection.



### Menu Settings

Press Extra Dry/Sanitize button(6) for 3 seconds to enter menu. Water hardness setting (e.g. SL1) is seen first. Press Delay buttons(4) to surf through menu. Then, press Half Load button(5) to enter to the levels of the setting you want to change in the menu. At this time display(3) blinks and that means this setting can be changed by pressing Delay buttons(4). Set the new level with Delay buttons(4) and press Wash Zone button(5) to save new level. After that display(3) will light up constantly and that means this setting level is saved. You can change another setting with these steps or exit from menu by pressing Extra Dry/Sanitize button(6) for 3 seconds or turning off/on.

No	Setting	Options	Description
1	Water Hardness	SL1*	Set the water hardness.
		SL2	
		SL3	
		SL4	
		SL5	
		SL6	
2	Rinse Aid	r:1	Set the amount of rinse aid.
		r:2	
		r:3	
		r:4*	
		r:5	
3	Buzzer Sound Control	b:0	Set the buzzer sound level.
		b:1	
		b:2	
		b:3*	
4	Start Programme	LP0*	Set a default programme for when the appliance switched on.
		LP1	
5	Save Power Mode	SP0	Set the Save Power Mode.
		SP1*	
		SP2	
6	Factory Setting	FS0*	Restore changed settings to the factory settings.
		FS1	

\*Default setting

### 1. Water Hardness

To change the water hardness setting, follow the "4.7 Water Hardness Setting".

### 2. Rinse Aid

To change the rinse aid setting, follow the "4.12 Rinse Aid Setting".

### 3. Buzzer Sound Control

To change the buzzer sound control, follow the "Menu Settings". "b:3" level is the highest sound level. "b:0" level means all voices are off.

### 4. Start Programme

To change the start programme selection, follow the "Menu Settings". In "LP0" level, machine turns on with Regular program. In "LP1" level, machine turns on with last selected program and option.

### 5. Save Power Mode

To change the save power mode setting, follow the "Menu Settings". In "SP0" level, interior lights(if available) will always be off, the screen will turn off after 4 minutes and the machine will turn off after 15 minutes of no activity in order to save energy. In "SP1" level, interior lights will turn off after 4 minutes when the door is opened, the screen will turn off after 4 minutes and the machine will turn off after 15 minutes of no activity in order to save energy. In "SP2" level, when the machine is off position, interior lights will turn off after 4 minutes when the door is opened. When the machine is on position, interior lights is on as long as the door stays open and machine will not turn off except by pressing On/off button.

### 6. Factory Setting

To change the factory setting, follow the "Menu Settings". If you change the level as "FS1" in factory setting, all settings return to default setting.

**Infoled 2.1 (Model Dependent)**

Infoled that is positioned on the bottom side of the dishwasher shines a light on to floor to indicate the current status of the dishwasher during washing.

LED Indicator	State of the Machine
Red, continuous	The machine is running a program.
Red, flashing	A program is cancelled.
Red, flashing rapidly	The machine has a fault. Refer to section " <b>Automatic fault warnings and what to do</b> ".
Green, continuous	A program is finished.

## 8 MAINTENANCE AND CLEANING

**⚠ WARNING :** Before cleaning or carrying out maintenance, switch off the appliance, disconnect the mains plug and turn off the water tap.

Your dishwasher can only be repaired by an authorized service agent. Do not try to repair your machine unless any recommendation by this manual

**⚠ WARNING :** All surfaces are susceptible to scratching. Contact with unsuitable cleaning agents can alter or discolor all surfaces.

**⚠ WARNING :** Keep the floor around your dishwasher clean and dry to prevent any possible injury. We recommend to keep your dish washer clean, empty and door cracked open to allow air to circulate in case of any extended unused time.

Dishwasher door can be damaged by abrasive cleaners, scouring pads, abrasive cloths. Cleaning the machine in regular intervals prolongs the machine's service life.

Oil and lime may accumulate in the machine's washing section. In case of such accumulation; -Fill the detergent compartment without loading any dishes into the machine, select a program that runs at high temperature, and start the machine.

In case of insufficiency, use special cleansing material available in the market. (Cleansing material produced special to machines by detergent producers.)

Cleaning the seals in the machine door, - To clean any accumulated residues in the door seals, wipe the seals regularly by using a dampened cloth.

Cleaning the machine, Clean the filters and spray arms at least once a month.

Unplug your machine and turn off its tap before starting the cleaning.

Do not use hard materials when cleaning your machine. Wipe with a fine cleaning material and a dampened cloth.

Filters Check if any food wastes have remained on the coarse and fine filters. If any food wastes are left, remove the filters and clean them thoroughly under the water tap.

### Filter

- a. Micro Filter
- b. Coarse Filter
- c. Metal/Plastic

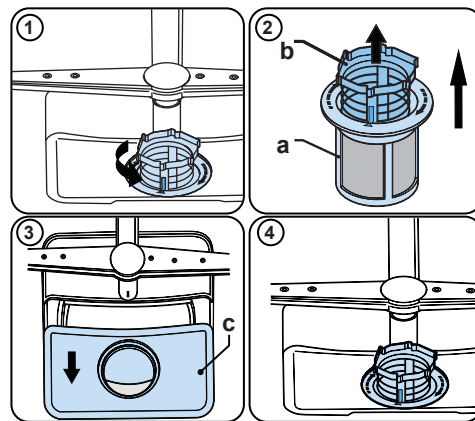

### Spray Arms

Check whether or not the holes for the upper and lower spray arms are clogged. If there is any clogging, remove the spray arms and clean them under water.

You can remove the lower spray arm by pulling it upwards, while the upper spray arm nut can be removed by turning the nut to the left.

Be sure that the nut is perfectly tightened when refitting the upper spray arm.

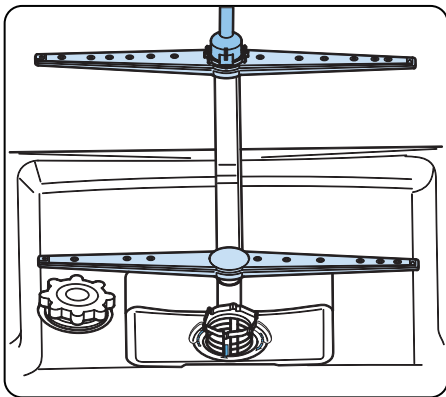

### Cleaning The Impellers

Clean the impellers at least once a week in order for the machine operates efficiently.

#### Lower Impeller

Check if the holes on the lower impeller (1) are clogged. If they are clogged, remove and clean the impeller. Pull the lower impeller up to remove it (A, B.)

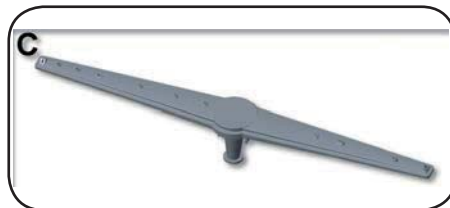
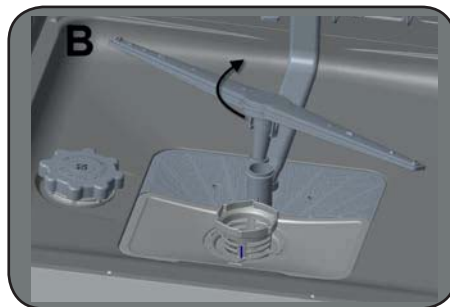
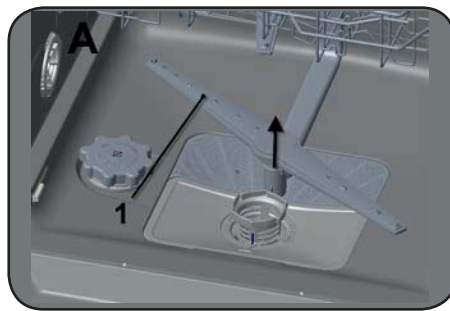

### Upper Impeller

Check if the holes on the upper impeller 1 are clogged. If they are clogged, remove and clean the impeller. Turn its nut to left to re-move the upper impeller (A, B) Make sure that the nut is tightened well when installing the upper impeller.

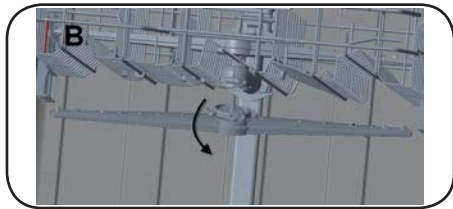

## WHAT SHOULD NOT BE WASHED IN YOUR DISHWASHER?

- All items to be placed in the dishwasher should be dishwasher safe.
  - Plastics with “dishwasher safe” or equivalent label can only be used in dishwashers.  
Plastics may lose their shape or color. Check with manufacturer for recommendations.
  - Any dishes made out of wood or made out with wooden parts are not suitable for washing in dishwashers. High temperatures can cause the wood swell or crack.
  - Silver items without dishwasher safe label should not be washed in the dishwasher because high temperatures and detergent can damage your silver. Check with manufacturer for recommendations.
  - Dishwasher safe silver items and stainless steel items should not come into contact, as the silver can become discolored.
  - Porcelains and glassware with decorations and hand-painted utensils may lose their color and patterns due to the high temperatures. Non-decorated items are dishwasher-proof.  
Check with manufacturer for recommendations.
  - Aluminum can turn dark in the dishwasher due to the heat, the detergent used or even just certain minerals in your water.
  - Do not wash sponges or dish cloths in dishwasher.
  - Do not wash any material like acrylic, copper, brass, pewter, iron, bronze or tin.
  - Pots without a non-stick coating are safe to be cleaned by your dishwasher but some non-stick pots and pans can lose their coating and also sticking ability.
  - Glued dishes or cutlery are not suitable for machine washing since adhesives that join materials such as plastic, wood, bone, steel, copper, tin, etc. may loosen.
- Remember, if there is any doubt about any aspect concerning items to be washed in

the dishwasher, follow the instructions from the manufacturer of the items, or wash the items by hand.



**WARNING:** If in doubt, wash by hand or follow the instructions from the manufacturer of utensils, dishes, glasses or pots and pans. Do not wash items soiled with cigarette ash, candle wax, varnish, paints or chemicals since they can damage your dishwasher.



**WARNING:** Empty the lower rack first and then the upper rack. This will avoid water dripping from the upper rack onto dishes in the lower rack.



**WARNING:** In general, it is not advisable to open the door while the dishwasher is in operation. If the door is opened, a safety device stops the dishwasher. Care should be taken when opening the door immediately following the cycle, as steam may escape.

## 9 TROUBLESHOOTING

FAULT	POSSIBLE CAUSE	TROUBLESHOOTING
The programme does not start.	Your Dishwasher is not plugged in.	Plug your Dishwasher in.
	Your Dishwasher is not switched on.	Switch your Dishwasher on by pressing the On/Off button.
	Fuse blown.	Check your indoor fuses.
	Water inlet tap is closed.	Turn on the water inlet tap.
	Your Dishwasher door is open.	Close the Dishwasher door.
	Water inlet hose and machine filters are clogged.	Check the water inlet hose and machine filters and make sure they are not clogged.
Water remains inside the machine.	Water drain hose is clogged or twisted.	Check the drain hose, then either clean or untwist it.
	The filters are clogged.	Clean the filters.
	The programme is not finished yet.	Wait until the programme is finished.
Machine stops during washing.	Power failure.	Check mains power.
	Water inlet failure.	Check water tap.
Shaking and hitting noises are heard during a wash operation.	The spray arm is hitting the dishes in the lower basket.	Move or remove items blocking the spray arm.
Partial food wastes remain on the dishes.	Dishes placed incorrectly, sprayed water not reaching affected dishes.	Do not overload baskets.
	Dishes leaning each another.	Place dishes as instructed in the section on loading your dishwasher.
	Not enough detergent used.	Use the correct amount of detergent, as instructed in the programme table.
	Wrong wash programme selected.	Use the information in the programme table to select the most appropriate programme.
	Spray arms clogged with food waste.	Clean the holes in the spray arms with thin objects.
	Filters or water drain pump clogged or filter misplaced.	Check the drain hose and filters are correctly fitted.

<b>FAULT</b>	<b>POSSIBLE CAUSE</b>	<b>TROUBLESHOOTING</b>
Whitish stains remains on dishes.	Not enough detergent used.	Use the correct amount of detergent, as instructed in the programme table.
	Rinse aid dosage and/or water softener setting set too low.	Increase rinse aid and/or water softener level.
Dishes do not dry.	Drying option is not selected.	Select a programme with a drying option.
	Rinse aid dosage set too low.	Increase rinse aid dosage setting.
Rust stains form on the dishes.	Stainless-steel quality of the dishes is insufficient.	Use only dishwasher-proof sets.
	A poor mains grounding.	Consult a qualified electrician immediately.
Detergent remains in the detergent compartment.	Detergent was added when the detergent compartment was wet.	Make sure detergent compartment is dry before use.

## AUTOMATIC FAULT WARNINGS AND WHAT TO DO

TROUBLE CODE	POSSIBLE FAULT	WHAT TO DO
FF	Water inlet system failure	Make sure the water inlet tap is open and water is flowing.
		Separate the inlet hose from the tap and clean the filter of the hose.
		Contact for service if the error continues.
F5	Pressure system failure	Contact for service.
F3	Continuous water input	Close the tap and contact for service.
F2	Inability to discharge water	Water discharge hose and filters may be clogged.
		Cancel the program.
		If the error continues, contact for service.
F8	Heater error	Contact for service.
F1	Overflow	Unplug the machine and close the tap.
		Contact for service.
F7	Overheating	Contact for service.
F9	Divisor position error	Contact for service.
F6	Faulty heater sensor	Contact for service.
HI	High voltage failure	Contact for service.

## **10 PRACTICAL INFORMATION**

1. When the machine isn't in operation:
  - Disconnect the plug and close the tap.
  - Leave the door slightly open to prevent odour formation.
2. Select the dry option to remove water droplets.
3. Place dishes in the machine properly to achieve the best energy consumption, washing and drying performance. Please see the program and consumption table for more information.
4. Rinse dirty dishes before placing them in the dishwasher.
5. Only use the Rinse program when necessary.
6. Do not place the machine near a refrigerator because it will reach high temperatures.
7. If the machine is located in an area that is at risk of freezing, close the tap, disconnect the inlet hose from the tap and drain the water inside the hose and the machine completely. penses outside the metropolitan region.