

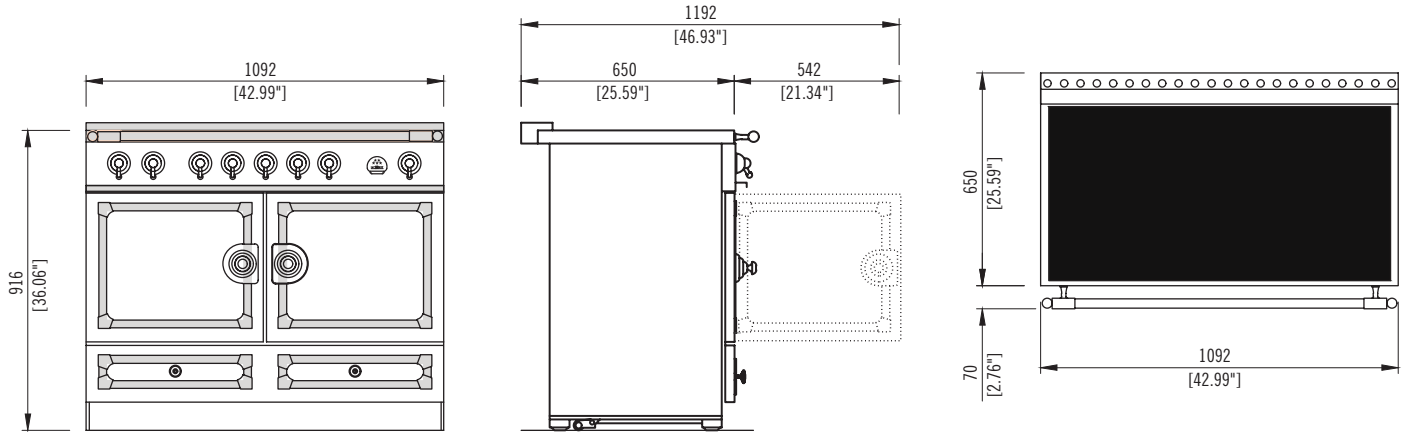

110 INDUCTION: C1-I



The original CornuFé range, this 43" range is your first La Cornue love. available in eleven colors and three trim accent choices of Polished Brass, Satin Chrome and Polished Chrome. The CornuFé 110 features two electric convection ovens, one of which is a seven mode multifunction oven, the other an electric convection oven, a five zone powerful induction cooktop constructed of durable ceramic glass that easily wipes clean, and one large storage drawer.



SPECIFICATIONS

CORNUFÉ 110 INDUCTION: c1-i

1092 W x 720 D x 915 (942 max) H (mm)
 43 W x 28.6 D x 36.3 (36.9 max) H (inches)
 350 lb. uncrated 465 lb. crated
 High-performance 5 zone induction cooktop
 Double electric convection ovens

Induction Cooktop ratings:

Front Left: 1.4 kW (Max) 2.2 kW (Boost)
 Rear Left: 1.85 kW (Max) 3.0 kW (Boost)
 Center: 2.3 kW (Max) 3.7 kW (Boost)
 Front Right: 1.85 kW (Max) 3.0 kW (Boost)
 Rear Right: 1.85 kW (Max) 3.0 kW (Boost)

Ovens:

French side-swing enameled steel doors
 2 Electric Convection Ovens, one of which features 7 cooking modes
 4 Interior Oven Racks Included (2 flat racks, 2 dropped racks)
 2 Enamel Baking Trays and 1 Trivet
 Left Oven: 430 W x 370 D x 380 H (mm)
 16.9 W x 14.6 D x 15 H (inches)
 2.2 cubic feet
 Right Oven: 430 W x 370 D x 410 H (mm)
 16.9 W x 14.6 D x 16.2 H (inches)
 2.39 cubic feet

POWER

Voltage: 240v; 60Hz, 50 AMP

FINISHES

Five Classic Colors: Matte Black, Stainless Steel, Gloss Black, Provence Blue, and Pure White

Four Étoile Colors: Morning Dew, Graphite, Ocean, and Wintersky

Suzanne Kasler Color Collection Colors: Tapestry and Roquefort

Three Trim Options: 1) Stainless Steel Trim and Rail with Satin Chrome Accents, 2) Stainless Steel Trim with Polished Brass Rail and Accents, and 3) Stainless Steel Trim, Polished Stainless Steel Rail, with Polished Chrome Accents

NOTE: Side panels are stainless steel for all colors except Gloss Black and Matte Black ranges have flat black side panels. The Polished Brass Trim is natural, non coated metal and will patina over time.



110 INDUCTION: C1-I

CORNUFÉ HOOD COLLECTION

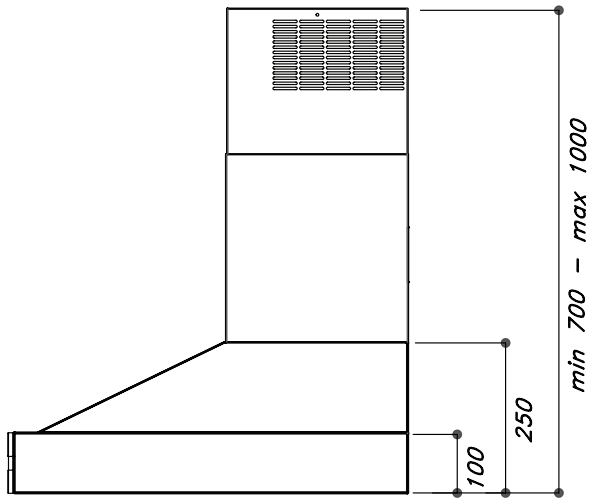

CORNUFÉ 110 HOOD: H1

- 1100 W x 650 D x 700 H (mm)
- 43.3 W x 25.6 D x 27.5 H (inches)
- Traditional wall-mounted chimney hood
- Available in all color and trim options
- 4-Speed Variable Motor
- One 600 CFM blower – unobstructed air flow with Ø6" duct
- Remote Control and In-Hood Activation Controls
- Three 20W high-intensity Halogen lights
- 2 dishwasher-safe baffle filters with grease capture system
- Voltage: 120v; 60Hz, total rating: 425W, 3.6 AMP
- Telescopic flue cover extends to maximum hood height of 39.3" (1000 mm)

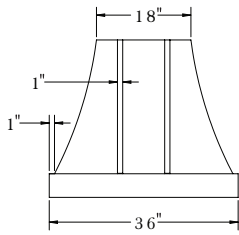

FRONT VIEW

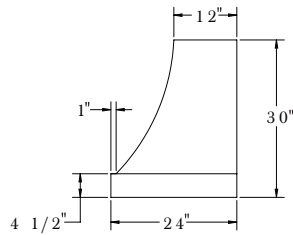

SIDE VIEW

CORNUFÉ CASCADE : CH3630CAC & CH4430CAC

- Hood Style: Concave
- Available in both 36" & 44"
- 36"W x 24"D x 30"H (600 cfm/8" collar)
- 44"W x 24"D x 30"H (1200 cfm/10" collar)

- Duct Cover Options:
- 12", 24" and 48" Tall
- Custom Duct Cover heights are available*

- Product Weight:
- 36"(30"H) : 97 lbs
- 44"(30"H) : 124 lbs

- Electrical Requirements:
- 600 CFM models draw approx. 2.7 Amps
- 1200 CFM models draw approx. 5.4 Amps

- Hood Sone Level:
- Ranges from 5-7

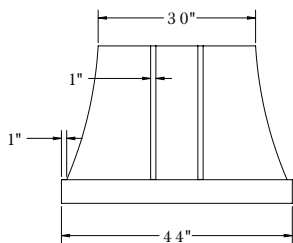

FRONT VIEW

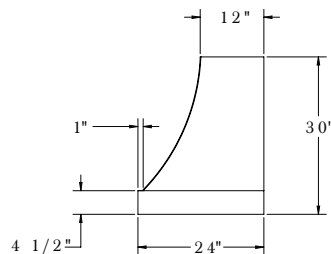

SIDE VIEW



110 INDUCTION: C1-I

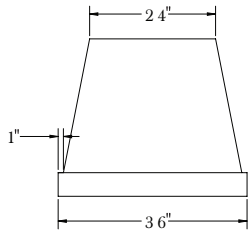

FRONT VIEW

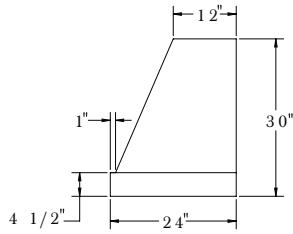

SIDE VIEW

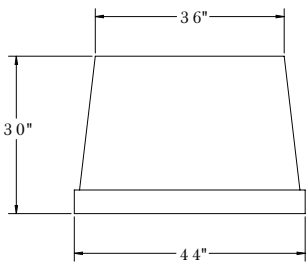

FRONT VIEW

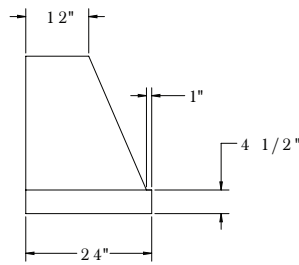

SIDE VIEW

CORNUFÉ EUCLID : CH3630EUC & CH4430EUC

Hood Style: Trapezoid

Available in both 36" & 44"
 36"W x 24"D x 30"H (600 cfm/8" collar)
 44"W x 24"D x 30"H (1200 cfm/10" collar)

Duct Cover Options:
 12", 24" and 48" Tall
Custom Duct Cover heights are available

Product Weight: 36"(30"H) : 98 lbs/ 44"(30"H) : 126 lbs

Electrical Requirements:
 600 CFM models draw approx. 2.7 Amps
 1200 CFM models draw approx. 5.4 Amps

Hood Sone Level:
 Ranges from 5-7

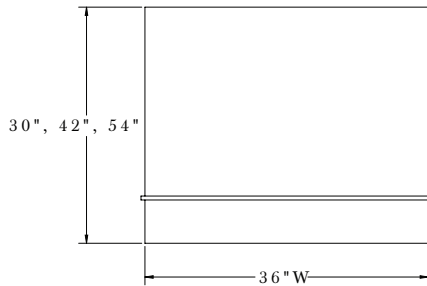

FRONT VIEW

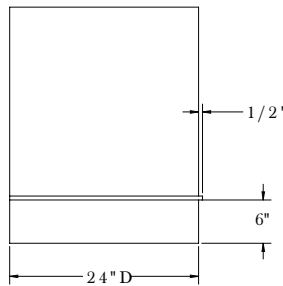

SIDE VIEW

CORNUFÉ LOGE : CH3630LGE & CH4430LGE

Hood Style: Box

Available in both 36" & 44"
 36"W x 24"D x 30"H, 42"H or 54"H (600 cfm/8" collar)
 44"W x 24"D x 30"H, 42"H or 54"H (1200 cfm/10" collar)

Product Weight:
 36"(30"H) : 104 lbs / 36"(42"H) : 122 lbs / 36"(54"H) : 141 lbs
 44"(30"H) : 130 lbs / 44"(42"H) : 151 lbs / 44"(54"H) : 172 lbs

Electrical Requirements:
 600 CFM models draw approx. 2.7 Amps
 1200 CFM models draw approx. 5.4 Amps

Hood Sone Level:
 Ranges from 5-7

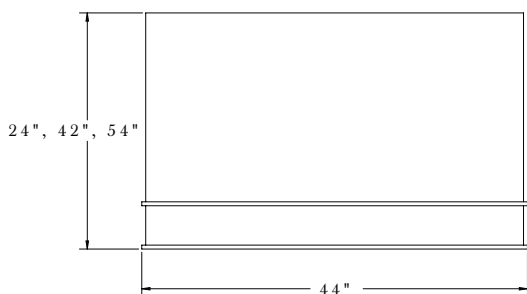

FRONT VIEW

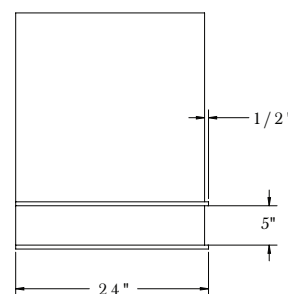

SIDE VIEW



110 INDUCTION: C1-I

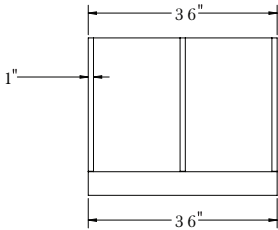

FRONT VIEW

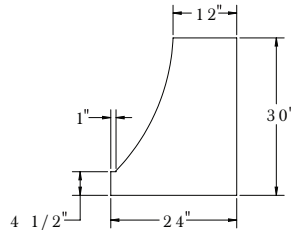

SIDE VIEW

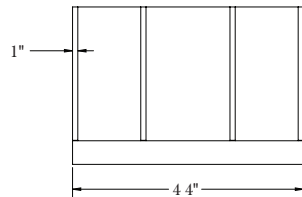

FRONT VIEW

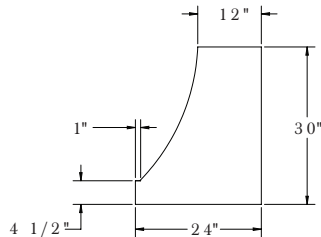

SIDE VIEW

CORNUFÉ MARQUEE : CH3630MRQ & CH4430MRQ

Hood Style: Arched Front

Available in both 36" & 44"
 36"W x 24"D x 30"H (600 cfm/8" collar)
 44"W x 24"D x 30"H (1200 cfm/10" collar)

Duct Cover Options:
 12", 24" and 48" Tall
Custom Duct Cover heights are available

Product Weight: 36"(30"H) : 101 lbs/ 44"(30"H) : 126 lbs

Electrical Requirements:
 600 CFM models draw approx. 2.7 Amps
 1200 CFM models draw approx. 5.4 Amps

Hood Sone Level:
 Ranges from 5-7

CORNUFÉ SERIES DETAILS & ACCESSORIES

CLASSIC COLORS

N	Matte Black
M	Gloss Black
I	Stainless Steel
W	Pure White
L	Provence Blue

ÉTOILE COLORS

P	Morning Dew
G	Graphite
O	Ocean
H	Wintersky

SUZANNE KASLER COLORS

A	Tapestry
Q	Roquefort

TRIM OPTIONS

	Trim	Accents	Rails
N	Stainless Steel	Satin Chrome	Stainless Steel
F	Stainless Steel	Polished Brass	Polished Brass
P	Stainless Steel	Polished Chrome	Polished Stainless Steel

Note: The Polished Brass Trim is natural, non coated metal and will patina over time.

ACCESSORIES:

Part Number	Description
09KIRSIR01	Recirculating kit for CornuFé Hood
P030292	CornuFé 110 Extra Flat Rack

Please confirm inventory status at time of order.