



**INSTRUCTIONS D'ASSEMBLAGE**  
**ASSEMBLY INSTRUCTIONS**

---

**M**ONARCH  
SPECIALTIES INC.

# I 1341

---

**TABLE A MANGER -**  
**36"X 60" BOIS PLAQUE ANTIQUE BRUN**

**DINING TABLE -**  
**ANTIQUE BROWN VENEER 36"X 60"**



**POUR DE L'ASSISTANCE OU POUR COMMANDER**  
**DES PIÈCES CONTACTEZ NOTRE DÉPARTEMENT**  
**DE SERVICE À LA CLIENTÈLE.**

**FOR ASSISTANCE OR TO ORDER PARTS**  
**CONTACT OUR CUSTOMER SERVICE DEPARTMENT**

**WWW.MONARCHSERVICE.COM**

**LISTE DES PIÈCES**  
**PARTS LIST**

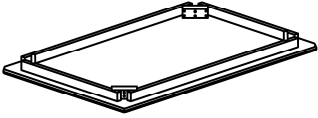
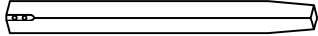
PIÈCE / PART #	IMAGE	DESCRIPTION	QTY / QTÉ
1		<p>TABLE TOP SURFACE DE TABLE</p>	1
2		<p>TABLE LEG PATTE DE TABLE</p>	4

**LISTE DES PIÈCES DE MONTAGE**  
**HARDWARE LIST**

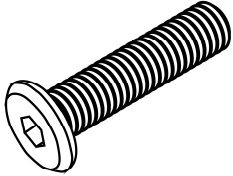
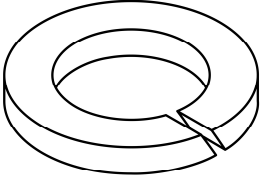
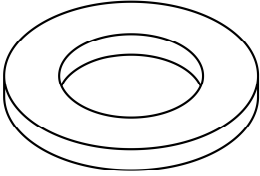
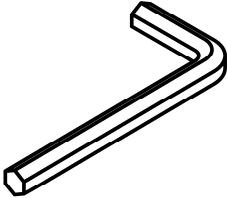
PIÈCE / PART #	IMAGE	DESCRIPTION	QTY / QTÉ
A		<p>ASSEMBLING BOLT - 3/8" X 2 3/4"</p> <p>BOULON D'ASSEMBLAGE - 3/8" X 2 3/4"</p>	8
B		<p>LOCK WASHER - 3/8" X 1/2"</p> <p>ENTRETOISE DE MÉTAL - 3/8" X 1/2"</p>	8
C		<p>METAL WASHER - 3/8" X 7/8"</p> <p>RONDELLE DE MÉTAL - 3/8" X 7/8"</p>	8
D		<p>HEX KEY</p> <p>CLÉ HEXAGONALE</p>	1



OUTIL DE VÉRIFICATION DE DIMENSIONS DES PIÈCES  
HARDWARE DIMENSIONS VERIFICATION TOOL



ÉTAPE / STEP 1

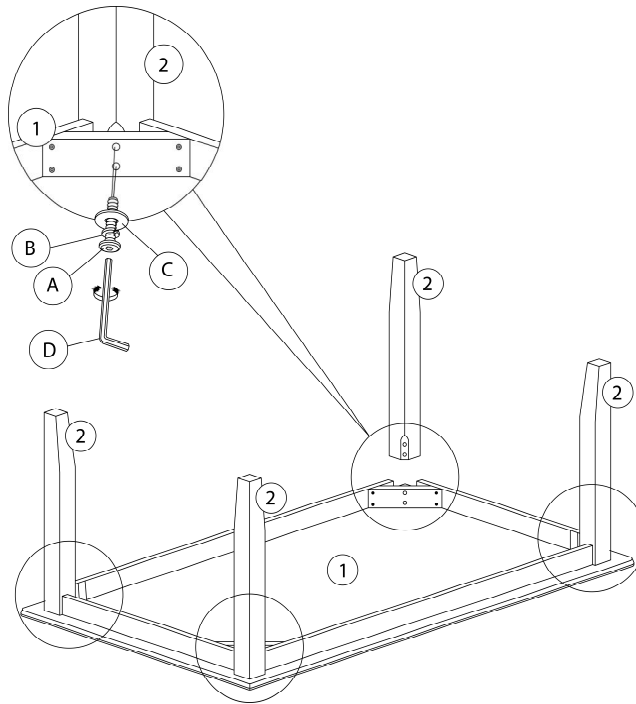

ÉTAPE / STEP 2

