

SPR48UGMX

Cooker size	48"
Type of main oven	Thermo-ventilated
Type of second oven	Thermo-ventilated
EAN code	8017709348465



Aesthetics



Design	Square design	Type of pan stands	Cast Iron
Front panel color	Stainless steel	Type of control setting	Control knobs
Aesthetic	SPR	No. of controls	10
Logo	Assembled st/steel	Serigraphy colour	Black
Colour	Stainless steel	Display	Touch
Logo position	Facia below the oven	Handle	Smeg new design with knurled handle
Finishing	Satin	Storage compartment	Drawer
Hob colour	Stainless steel	Plinth	Black

Programs / Functions

No. of cooking functions 9

Traditional cooking functions

Static	Fan assisted	Circulaire
Small grill	Large grill	Fan grill (large)
Base	Fan assisted bottom	Pizza

Other functions

Defrost by time

Cleaning functions

 Vapor clean

Programs / Functions Auxiliary Oven

Bottom element + fan



Hob technical features

Total no. of cook zones 6

Left - 22000 BTU

Rear centre - 15000 BTU

Front centre - 5000 BTU

Central - 1.40 kW

Rear right - 15000 BTU

Front right - 8000 BTU

Gas safety valves Yes

Burner caps

Matt black enamelled

Main Oven Technical Features



No. of lights 2
Fan number 2
Gross volume, 1st cavity 4.45 cu. ft.
Cavity material Ever Clean enamel
No. of shelves 5
Type of shelves Metal racks
Light type Halogen
Light Power 40 W
Cooking time setting Start and Stop
Light when oven door is open Yes
Removable door Yes

Total no. of door glasses 3
Safety Thermostat Yes
Cooling system Tangential
Lower heating element power 1700 W
Upper heating element - Power 1200 W
Grill element 1700 W
Large grill - Power 2900 W
Circular heating element - Power 1500 W
Grill type Electric
Soft Close system Yes

Options Main Oven

Timer Yes
End of cooking acoustic alarm Yes

Minimum Temperature 120 °F
Maximum temperature 500 °F

Second Oven Technical Features



Fan number	1	Removable door	Yes
Gross volume, 2nd cavity	39 cu. ft.	No. total door glasses	3
Cavity material	Ever Clean enamel	Safety Thermostat	Yes
No. of shelves	5	Cooling system	Tangential
Type of shelves	Metal racks	Lower heating element - power	750 W
No. of lights	2	Large grill - Power	2050 W
Light type	Halogen	Circular heating element - Power	1500 W
Light Power	40 W	Soft Close system	Yes
Light when oven door is open	Yes		

Options Auxiliary Oven

Minimum Temperature	120 °F	Maximum temperature	450 °F
----------------------------	--------	----------------------------	--------

Accessories included for Main Oven & Hob



Cast iron wok support	1	Telescopic Guide rails, total Extraction	1
TOP Oven grid with back stop	2		

Accessories included for Secondary Oven



Rack with back and side stop	2	Telescopic Guide rails, total Extraction	1
-------------------------------------	---	---	---

Electrical Connection

Electrical connection rating	8500 W	Power supply cable length	47 1/4 "
Current	35 A	Frequency	60 Hz
Circuit breaker	40 A	Terminal block	3 poles
Voltage	208/240 V	Plug	(B) NEMA 14-50P
Type of electric cable installed	Yes, Double phase		

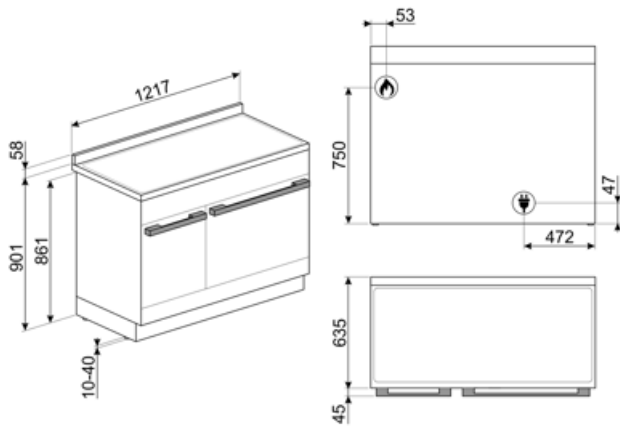

Compatible Accessories



GRM

Coffee machine support



GT3T

Totally extractable telescopic guides



PALPZ

Pizza shovel with folding handle. Dimensions L31.5 x H32.5 cm. Easy and convenient to use and store. Perfect for serving pizza, bread and savory pastries in a safe and professional way.



SFLK1

Child lock



STONE9

















Rectangular pizza stone, suitable for 90cm wide ovens. Dimensions W64 x H2.3 x D37.5cm. Ideal for cooking pizza with the same aroma and crispness as are typical of a wood-fired oven. Can also be used for baking bread, focaccias and other recipes such as pies and flans or biscuits













WOKGHU

Cast iron WOK Support

Symbols glossary

 <p>Heavy duty cast iron pan stands: for maximum stability and strength.</p>	 <p>Knobs control</p>
 <p>Air cooling system: to ensure a safe surface temperatures.</p>	 <p>Defrost by time: Manual defrost function. At the end of the set duration, the function stops.</p>
 <p>Triple glazed doors: Number of glazed doors.</p>	 <p>Ever Clean Enamel: Ever Clean enamel is applied electrostatically, corner to corner and edge to edge to prevent cracking or cracks over time. It is a particular pyrolytic enamel, resistant to acids which, in addition to being pleasantly bright, promotes greater cleaning of the oven walls, thanks to its lower porosity. It is baked at over 850 ° C and slowly polymerized at a scientifically determined rate to ensure uniform depth and strength Ever Clean enamel creates an impeccable finish both on the inside of the oven and on the trays, making the surfaces of the oven incredibly easy to maintain over time as it reduces the adhesion of fat during cooking</p>
 <p>Fan assisted base: the mix of fan and lower heating element alone allows to finish cooking foods already cooked on the surface but not internally more quickly. This system is recommended to finish cooking foods that are already well cooked on the surface, but not internally, which therefore require a moderate higher heat. Ideal for any type of food.</p>	 <p>Fan assisted: Intense and homogeneous traditional cooking, also suitable for complex recipes. The fan is active and the heat comes from below and from above at the same time. Ventilated cooking ensures a faster and more homogeneous result, leaving fragrant foods outside and moister inside. Ideal for baked pasta, biscuits, roasts and cobblers.</p>
 <p>Static: Traditional cooking suitable for the preparation of one dish at a time. The fan is not active and the heat comes from below and from above at the same time. Static cooking is slower and more delicate, ideal in order to get well cooked and dry dishes even inside. Ideal for cooking all types of roasts, fatty meats, bread, filled cakes.</p>	 <p>Base: the heat comes only from the bottom of the cavity. The fan is not active. Ideal for sweet and savory pies, cobblers and pizzas. Designed to complete cooking and make food more crunchy This symbol in gas ovens indicates the gas burner.</p>
 <p>Circulaire: it is the perfect function for cooking all types of dishes in a more delicate way. The heat comes from the back of the oven and is distributed quickly and evenly The fan is active. It is also ideal for cooking on multiple levels without mixing smells and flavors.</p>	 <p>Grill: Very intense heat coming only from above from a double heating element. The fan is not active. Provides excellent grilling and gratinating results. Used at the end of cooking, it gives a uniform browning to dishes.</p>
 <p>Half grill: For rapid cooking and browning of foods. Best results can be obtained by using the top shelf for small items, the lower shelves for larger ones, such as chops or sausages. For half grill heat is generated only at the centre of the element, so is ideal for smaller quantities.</p>	 <p>Fan grill: very intense heat coming only from above from a double heating element The fan is active. It allows the optimal grilling of thickest meats. Ideal for large cuts of meat.</p>
 <p>Light</p>	 <p>Pizza function: Specific function for cooking pizza in a pan. It allows to obtain a pizza that is soft inside and crispy outside with the topping perfectly cooked, not dry and not burnt.</p>

-
- | | |
|---|--|
|  <p>Side lights: Two opposing side lights increase visibility inside the oven.</p> |  <p>Automatic opening: some models have Automatic opening door when the cycle is finished which is a perfect solution for handle-less kitchen units as no handle is needed. For safety reasons, the door locks automatically when the machine is in use to avoid it being opened inadvertently.</p> |
|  <p>The oven cavity has 5 different cooking levels.</p> |  <p>Soft close: all models are equipped with advanced function of smooth closing of the door, which allows the device to close smoothly and quietly.</p> |
|  <p>Telescopic rails: allow you to pull out the dish and check it without having to remove it from the oven entirely.</p> |  <p>Electronic control: Allows you to maintain temperature inside the oven with the precision 2-3 ° C. This enables to cook meals that are very sensitive to temperature changes, such as cakes, souffles, puddings.</p> |
|  <p>Ultra rapid burners: Powerful ultra rapid burners offer up to 5kw of power.</p> |  <p>Vapor Clean: a simple cleaning function using steam to loosen deposits in the oven cavity.</p> |
|  <p>The capacity indicates the amount of usable space in the oven cavity in litres.</p> |  <p>4.3 inch display with LED technology, usability with knobs + 3 touch keys</p> |

Benefit (TT)

Ever Clean Enamel

Easy oven cleaning thanks to special pyrolytic enamel

Touch control

Easy and intuitive timer setting with a single touch

Drawer storage compartment

More space thanks to the lower compartment, ideal for storing accessories or cooking utensils

True-convection

The best cooking performances guaranteed by ventilated circular flow.

Multiple fans and heating elements guarantee the perfect aerodynamic heat flow, allowing homogeneous and quicker cooking inside the cavity.

Multilevel cooking

Several cooking levels allow maximum flexibility of use

Multilevel halogen light

Internal halogen lighting on different levels guarantees excellent visibility

Tangential cooling

New cooling system with tangential fan and airflow from the door to the splashback

Telescopic guides

Easy extraction and safe insertion of trays into the oven thanks to telescopic guides

Adjustable height

Cooker top flushed with the working area thanks to adjustable feet

AirFry (AIRFRY optional accessory)

Lighter and tastier food thanks to airfry basket

Cold door

During any function, the external door glass is cold, avoiding any risk of burns

Pizza stone (optional accessory)

Baking with refractory stone for soft and crispy pizza and yeast products (STONE optional accessory)

BBQ (optional accessory)

Barbeque cooking directly in the oven with the double-sided grill

Isothermic Cavity

The best cooking performance at the highest energy efficiency

Soft close

The door is equipped with a specific system for silent closing

Double Turbine

The oven has two fans equipped with two circular heating elements allowing cooking with rotating heat