

SOU2300TX



Category	24"
Product Family	Oven
Power supply	Electric
Cooking method	Thermo-ventilated
Cleaning system	Vapor Clean
EAN code	8017709341954



Aesthetics

Aesthetic	Classica	Type of steel	Brushed
Colour	Stainless steel	Serigraphy colour	Black
Finishing	Fingerproof	Serigraphy type	Symbols and wordings
Design	Flat	Handle Colour	Inox
Material	Stainless steel	Logo	Embossed

Controls



Display name	DigiScreen	Display technology	LED
--------------	------------	--------------------	-----

Programs / Functions

No. of cooking functions 8

Traditional cooking functions

Static	Fan assisted	Circulaire
Turbo	Eco	Large grill
Fan grill (large)	Base	

Other functions

Defrost by time

Cleaning functions



Options



Time-setting options Delay start and automatic end cooking

Minute minder Yes

Timer 1

Rapid pre-heating Yes

Technical Features



Capacity (Lt) 72 l

Cavity Sares

Minimum Temperature 38 °F

Maximum temperature 260 °F

No. of shelves 5

N. of fans 1

No. of lights 2

Light type Halogen

User-replaceable light Yes

Light Power 40 W

Light when door is opened Yes

Lower heating element power 1200 W

Upper heating element - Power 1000 W

Grill element - power 1700 W

Large grill - Power 2700 W

Circular heating element - Power 1550 W

Heating suspended when door is opened Yes

Door Temperate door

Removable inner door Yes

Total no. of door glasses 3

Cooling system Tangential

Cooling duct Double

Speed Reduction Cooling System Yes

Cavity material Ever clean Enamel

Performance / Energy Label



Net volume of the cavity 2.54 cu. ft.

Accessories Included



Rack with back stop 2

Enamelled deep tray (40mm) 1

Insert grid 1

Telescopic Guide rails, partial Extraction 1

Electrical Connection

Voltage 120/240 V

Current 2 13 A

Plug	Cable with free ends	Frequency (Hz)	60 Hz
Nominal power	3400 W	Power supply cable length	59 1/16 "
Voltage 2	120/208 V		

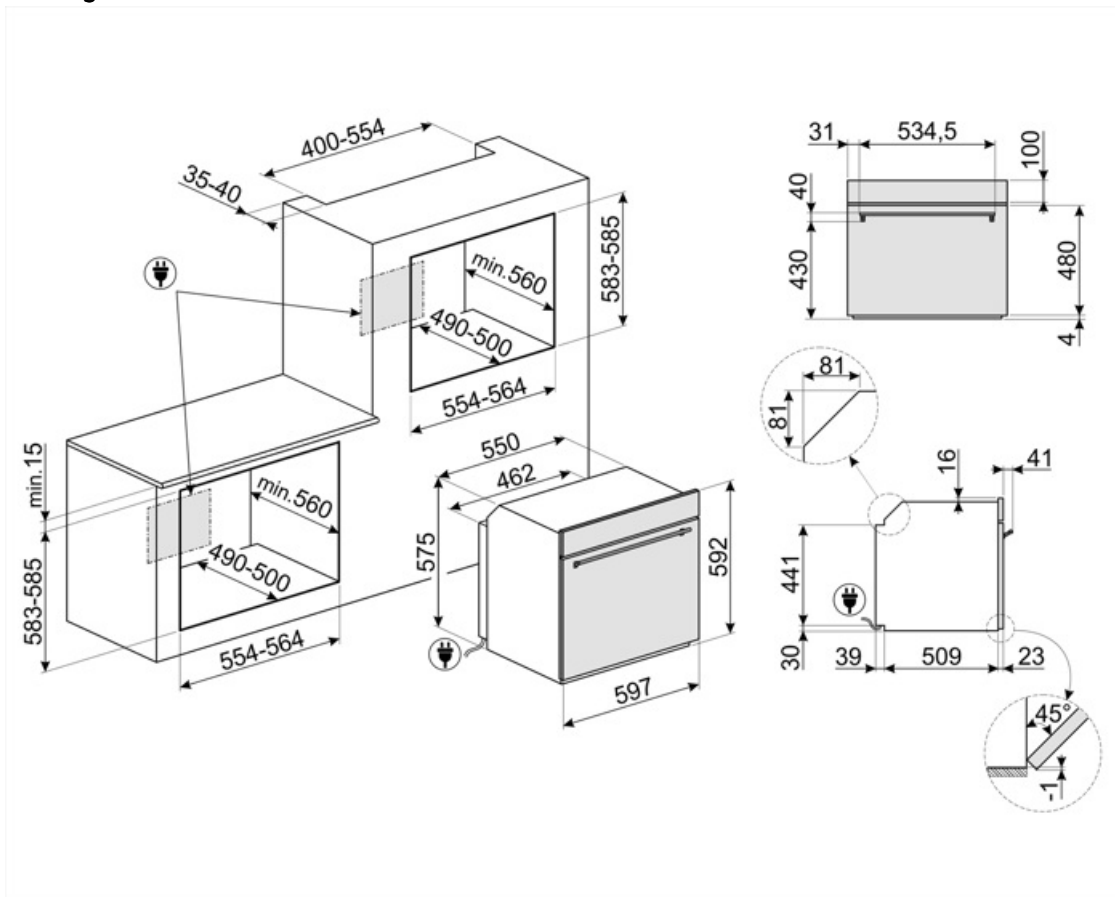

Compatible Accessories

AIRFRY2

Air fryer tray. Ideal for recreating traditional frying in the oven, but with fewer calories and less fat. It allows you to cook quickly and simply dishes such as French fries, fried vegetables and fish, ensuring perfect browning and crispiness.



BN640

Enamelled tray suitable for 45cm and 60cm ovens. Depth 540 mm. Perfect for cooking and roasting meat and fish in sauces. Also ideal for experimenting with lighter and crunchy side dishes



GTT

Totally extractable telescopic guides (1 level), suitable for traditional ovens. Made in stainless steel, they guarantee stability and facilitate the smooth extraction of the trays.



STONE2

Rectangular pizza stone without handles, suitable for 45cm and 60cm wide ovens. Dimensions W42 x H1.8 x D37.5cm. Ideal for cooking pizzas with the same results as a typical wood-fired oven. Can also be used for baking bread, focaccias and other recipes such as pies, flans or biscuits



BN620-1

Enamelled tray suitable for 45cm and 60cm ovens. Depth 20 mm. Perfect for a wide range of savoury and sweet baking.



GTP

Partially extractable telescopic guides (1 level), suitable for traditional ovens. Made in stainless steel, they guarantee stability and facilitate the smooth extraction of the trays.



























PALPZ

Pizza shovel with folding handle. Dimensions L31.5 x H32.5 cm. Easy and convenient to use and store. Perfect for serving pizza, bread and savory pastries in a safe and professional way.



Symbols glossary

 <p>A: Product drying performance, measured from A+++ to D / G depending on the product family</p>	 <p>Air cooling system: to ensure a safe surface temperatures.</p>
 <p>Defrost by time: Manual defrost function. At the end of the set duration, the function stops.</p>	 <p>Triple glazed doors: Number of glazed doors.</p>
 <p>Electric</p>	 <p>Ever Clean Enamel: Ever Clean enamel is applied electrostatically, corner to corner and edge to edge to prevent cracking or cracks over time. It is a particular pyrolytic enamel, resistant to acids which, in addition to being pleasantly bright, promotes greater cleaning of the oven walls, thanks to its lower porosity. It is baked at over 850 ° C and slowly polymerized at a scientifically determined rate to ensure uniform depth and strength Ever Clean enamel creates an impeccable finish both on the inside of the oven and on the trays, making the surfaces of the oven incredibly easy to maintain over time as it reduces the adhesion of fat during cooking</p>
 <p>Fingerprint proof stainless steel: Fingerprint proof stainless steel keeps stainless steel looking as good as new.</p>	 <p>Fan assisted: Intense and homogeneous traditional cooking, also suitable for complex recipes. The fan is active and the heat comes from below and from above at the same time. Ventilated cooking ensures a faster and more homogeneous result, leaving fragrant foods outside and moister inside. Ideal for baked pasta, biscuits, roasts and cobblers.</p>
 <p>Static: Traditional cooking suitable for the preparation of one dish at a time. The fan is not active and the heat comes from below and from above at the same time. Static cooking is slower and more delicate, ideal in order to get well cooked and dry dishes even inside. Ideal for cooking all types of roasts, fatty meats, bread, filled cakes.</p>	 <p>Base: the heat comes only from the bottom of the cavity. The fan is not active. Ideal for sweet and savory pies, cobblers and pizzas. Designed to complete cooking and make food more crunchy This symbol in gas ovens indicates the gas burner.</p>
 <p>Circulaire: it is the perfect function for cooking all types of dishes in a more delicate way. The heat comes from the back of the oven and is distributed quickly and evenly The fan is active. It is also ideal for cooking on multiple levels without mixing smells and flavors.</p>	 <p>ECO: low energy consumption cooking: this function is particularly suitable for cooking on a single shelf with low energy consumption. It is recommended for all types of food except those that can generate a lot of moisture (for example vegetables). To achieve maximum energy savings and reduce time, it is recommended to put the food in the oven without preheating the cooking compartment</p>
 <p>Grill: Very intense heat coming only from above from a double heating element. The fan is not active. Provides excellent grilling and gratinating results. Used at the end of cooking, it gives a uniform browning to dishes.</p>	 <p>Fan grill: very intense heat coming only from above from a double heating element The fan is active. It allows the optimal grilling of thickest meats. Ideal for large cuts of meat.</p>

-
-  Turbo: the heat comes from 3 directions: above, below and from the back of the oven The fan is active. It allows quick cooking, even on several shelves without mixing the aromas. Ideal for large volumes or foods that require intense cooking.
 -  The inner door glass: can be removed with a few quick movements for cleaning.
 -  Rapid preheating: cooking is preceded by the preheating phase which allows the cooking compartment to reach the set temperature. This option reduces the time by up to 50%.
 -  Telescopic rails: allow you to pull out the dish and check it without having to remove it from the oven entirely.
 -  The capacity indicates the amount of usable space in the oven cavity in litres.
 -  4.3 inch display with LED technology, usability with knobs + 3 touch keys
 -  All glass inner door: All glass inner door, a single flat surface which is simple to keep clean.
 -  Side lights: Two opposing side lights increase visibility inside the oven.
 -  The oven cavity has 5 different cooking levels.
 -  Vapor Clean: a simple cleaning function using steam to loosen deposits in the oven cavity.
 -  The capacity indicates the amount of usable space in the oven cavity in litres.