

SOU3300TX2



Category	30"
Product Family	Oven
Power supply	Electric
Heat source	ELECTRICITY
Cooking method	Thermo-ventilated
Cleaning system	Vapor Clean
EAN code	8017709339371



Aesthetics

Aesthetic	Classica	Type of steel	Brushed
Colour	Stainless steel	Serigraphy colour	Black
Finishing	Fingerproof	Serigraphy type	Symbols and wordings
Design	Flat	Logo	Embossed
Material	Stainless steel		





Controls



Display name	DigiScreen	No. of controls	2
Display technology	LED		

Programs / Functions

No. of cooking functions **8**
 Traditional cooking functions

 Static	 Fan assisted	 Circulaire
 Turbo	 Large grill	 Fan grill (small)
 Fan grill (large)	 Base	 Fan assisted base

Other functions

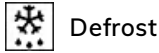

Defrost

Cleaning functions



Vapor Clean

Options

Time-setting options	Delay start and automatic end cooking	Timer	1
Minute minder	Yes		

Technical Features



Capacity (Lt)	111 l	Grill element - power	1700 W
Cavity	Altro	Large grill - Power	2900 W
Minimum Temperature	38 °F	Circular heating element - Power	2500 W
Maximum temperature	260 °F	Heating suspended when door is opened	Yes
No. of shelves	6	Door	Temperate door
N. of fans	1	Removable inner door	Yes
No. of lights	2	Total no. of door glasses	3
Light type	Halogen	Cooling system	Tangential
User-replaceable light	Yes	Cooling duct	Double
Light Power	40 W	Speed Reduction Cooling System	Yes
Light when door is opened	Yes	Temperature control	Electro-mechanical
Lower heating element power	1700 W	Cavity material	Ever clean Enamel
Upper heating element - Power	1200 W		

Performance / Energy Label

Net volume of the cavity 3.92 cu. ft.

Accessories Included



Rack with back stop	2	Insert gird	1
Enamelled deep tray (40mm)	1	Telescopic Guide rails, partial Extraction	1

Electrical Connection

Voltage	120/240 V	Current 2	14 A
Plug	Cable with free ends	Frequency (Hz)	60 Hz
Nominal power	3700 W	Power supply cable length	59 1/16 "
Voltage 2	120/208 V		

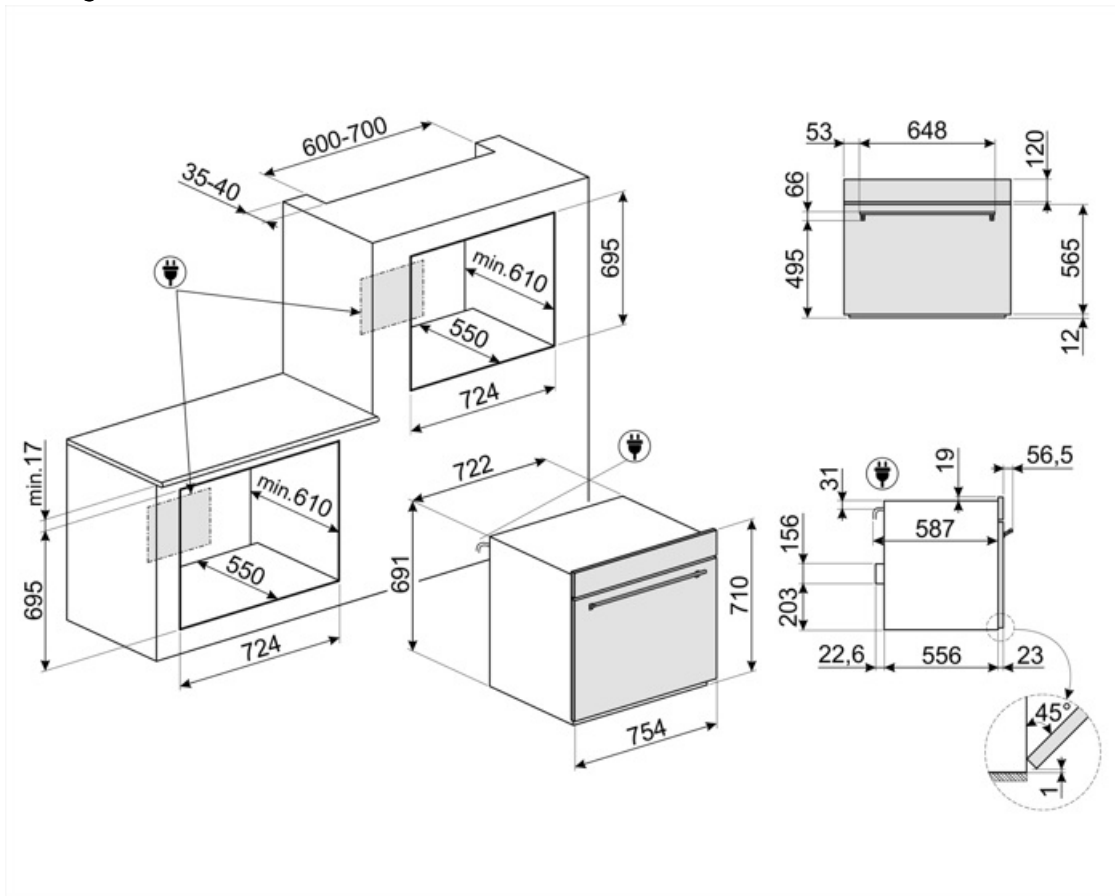

Compatible Accessories

GT3T

Totally extractable telescopic guides



STONE2

Rectangular pizza stone without handles, suitable for 45cm and 60cm wide ovens. Dimensions W42 x H1.8 x D37.5cm. Ideal for cooking pizzas with the same results as a typical wood-fired oven. Can also be used for baking bread, focaccias and other recipes such as pies, flans or biscuits

















PALPZ

Pizza shovel with folding handle. Dimensions L31.5 x H32.5 cm. Easy and convenient to use and store. Perfect for serving pizza, bread and savory pastries in a safe and professional way.



Symbols glossary

-  A: Product drying performance, measured from A+++ to D / G depending on the product family
-  With the switch on this symbol, no heating is possible even if the thermostat is turned.
-  Electric
-  Fingerprint proof stainless steel: Fingerprint proof stainless steel keeps stainless steel looking as good as new.
-  Fan assisted: Intense and homogeneous traditional cooking, also suitable for complex recipes. The fan is active and the heat comes from below and from above at the same time. Ventilated cooking ensures a faster and more homogeneous result, leaving fragrant foods outside and moister inside. Ideal for baked pasta, biscuits, roasts and cobblers.
-  Base: the heat comes only from the bottom of the cavity. The fan is not active. Ideal for sweet and savory pies, cobblers and pizzas. Designed to complete cooking and make food more crunchy. This symbol in gas ovens indicates the gas burner.
-  Fan with grill element: The fan reduces the fierce heat from the grill, providing an excellent method of grilling various foods, chops, steaks, sausages etc. giving even browning and heat distribution, without drying out the food. The top two levels recommended for use, and the lower part of the oven can be used to keep items warm at the same time, an excellent facility when cooking a grilled breakfast. Half grill (centre portion only) is ideal for small quantities of food.
-  Air cooling system: to ensure a safe surface temperatures.
-  Triple glazed doors: Number of glazed doors.
-  Ever Clean Enamel: Ever Clean enamel is applied electrostatically, corner to corner and edge to edge to prevent cracking or cracks over time. It is a particular pyrolytic enamel, resistant to acids which, in addition to being pleasantly bright, promotes greater cleaning of the oven walls, thanks to its lower porosity. It is baked at over 850 ° C and slowly polymerized at a scientifically determined rate to ensure uniform depth and strength. Ever Clean enamel creates an impeccable finish both on the inside of the oven and on the trays, making the surfaces of the oven incredibly easy to maintain over time as it reduces the adhesion of fat during cooking.
-  Fan assisted base: the mix of fan and lower heating element alone allows to finish cooking foods already cooked on the surface but not internally more quickly. This system is recommended to finish cooking foods that are already well cooked on the surface, but not internally, which therefore require a moderate higher heat. Ideal for any type of food.
-  Static: Traditional cooking suitable for the preparation of one dish at a time. The fan is not active and the heat comes from below and from above at the same time. Static cooking is slower and more delicate, ideal in order to get well cooked and dry dishes even inside. Ideal for cooking all types of roasts, fatty meats, bread, filled cakes.
-  Circulaire: it is the perfect function for cooking all types of dishes in a more delicate way. The heat comes from the back of the oven and is distributed quickly and evenly. The fan is active. It is also ideal for cooking on multiple levels without mixing smells and flavors.
-  Grill: Very intense heat coming only from above from a double heating element. The fan is not active. Provides excellent grilling and gratinating results. Used at the end of cooking, it gives a uniform browning to dishes.



Fan grill: very intense heat coming only from above from a double heating element. The fan is active. It allows the optimal grilling of thickest meats. Ideal for large cuts of meat.



Turbo: the heat comes from 3 directions: above, below and from the back of the oven. The fan is active. It allows quick cooking, even on several shelves without mixing the aromas. Ideal for large volumes or foods that require intense cooking.



All glass inner door: All glass inner door, a single flat surface which is simple to keep clean.



The inner door glass: can be removed with a few quick movements for cleaning.



Side lights: Two opposing side lights increase visibility inside the oven.



The oven cavity has 6 different cooking levels.



Telescopic rails: allow you to pull out the dish and check it without having to remove it from the oven entirely.



Vapor Clean: a simple cleaning function using steam to loosen deposits in the oven cavity.



4.3 inch display with LED technology, usability with knobs + 3 touch keys