

# SPR36UGMX

Cooker size	36"
Hob type	Gas
Type of main oven	Thermo-ventilated
EAN code	8017709316587



## Aesthetics











<b>Aesthetic</b>	SPR
<b>Serie</b>	Professional
<b>Colour</b>	Stainless steel
<b>Finishing</b>	Satin
<b>Command panel finish</b>	Stainless steel
<b>Logo</b>	Assembled
<b>Logo position</b>	Facia below the oven
<b>Upstand</b>	Yes

<b>Hob colour</b>	Black enamel
<b>Type of pan stands</b>	Cast Iron
<b>Type of control setting</b>	Control knobs
<b>Control knobs</b>	Smeg new design with knurled ferrule
<b>Controls colour</b>	Stainless steel
<b>Serigraphy colour</b>	Black
<b>Handle</b>	Smeg new design with knurled handle
<b>Handle Colour</b>	Brushed stainless steel

## Programs / Functions

No. of cooking functions 8

Traditional cooking functions

 Static	 Fan assisted	 Circulaire
 Small grill	 Large grill	 Fan grill (large)
 Fan assisted bottom	 Pizza	

### Other functions

 Defrost by time
--

## Cleaning functions

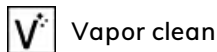

## Hob technical features

### Total no. of cook zones 6

Front left - 5.3 kW - 18000 BTU

Rear left - 2.9 kW - 10000 BTU

Front centre - 2.9 kW - 10000 BTU

Rear centre - 2.9 kW - 10000 BTU

Front right - 5.3 kW - 18000 BTU

Rear right - 2.9 kW - 10000 BTU

## Main Oven Technical Features



<b>No. of lights</b>	2	<b>Removable inner door</b>	Yes
<b>Fan number</b>	2	<b>Total no. of door glasses</b>	3
<b>Gross volume, 1st cavity</b>	4.45 cu. ft.	<b>Cooling system</b>	Tangential
<b>Cavity material</b>	Ever Clean enamel	<b>Lower heating element power</b>	1700 W
<b>No. of shelves</b>	5	<b>Upper heating element - Power</b>	1200 W
<b>Type of shelves</b>	Metal racks	<b>Grill element</b>	1700 W
<b>Light type</b>	Halogen	<b>Large grill - Power</b>	2900 W
<b>Light Power</b>	40 W	<b>Circular heating element - Power</b>	2 x 1550 W
<b>Cooking time setting</b>	Minute minder	<b>Grill type</b>	Electric
<b>Removable door</b>	Yes	<b>Soft Close system</b>	Yes
<b>Full glass inner door</b>	Yes		

## Options Main Oven

**Minimum Temperature** 149 °F

**Maximum temperature** 500 °F

## Accessories included for Main Oven & Hob

**Oven grid with stop, tray support** 2

**Meat Probe** 1

## Electrical Connection

**Plug** (B) NEMA 14-50P  
**Electrical connection rating** 3800 W  
**Current** 16 A  
**Circuit breaker** 20 A

**Type of electric cable installed** Yes, Double phase  
**Power supply cable length** 47 1/4 "

Voltage

208/240 V

Frequency

60 Hz

Terminal block

3 poles

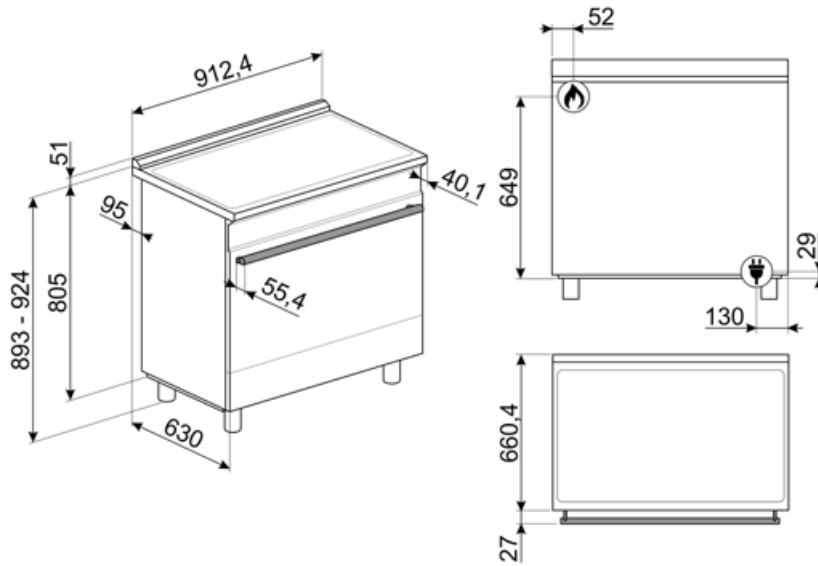

---

## Compatible Accessories

---



### GRM

Coffee machine support



### GT3T

Totally extractable telescopic guides



### KITTKSPR36

Plinth, 90cm, three sides, black, suitable for SPR cookers 36"



### SFLK1



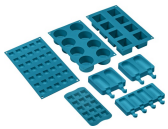













Child lock



### SMOLD

Set of 7 silicone moulds for ice creams, ice lollies, pralines, ice cubes or to portion food. Usable from -60°C to +230°C

## Symbols glossary

 <p>Heavy duty cast iron pan stands: for maximum stability and strength.</p>	 <p>Air cooling system: to ensure a safe surface temperatures.</p>
 <p>Defrost by time: Manual defrost function. At the end of the set duration, the function stops.</p>	 <p>Triple glazed doors: Number of glazed doors.</p>
 <p>Ever Clean Enamel: Ever Clean enamel is applied electrostatically, corner to corner and edge to edge to prevent cracking or cracks over time. It is a particular pyrolytic enamel, resistant to acids which, in addition to being pleasantly bright, promotes greater cleaning of the oven walls, thanks to its lower porosity. It is baked at over 850 ° C and slowly polymerized at a scientifically determined rate to ensure uniform depth and strength Ever Clean enamel creates an impeccable finish both on the inside of the oven and on the trays, making the surfaces of the oven incredibly easy to maintain over time as it reduces the adhesion of fat during cooking</p>	 <p>Fan assisted base: the mix of fan and lower heating element alone allows to finish cooking foods already cooked on the surface but not internally more quickly. This system is recommended to finish cooking foods that are already well cooked on the surface, but not internally, which therefore require a moderate higher heat. Ideal for any type of food.</p>
 <p>Fan assisted: Intense and homogeneous traditional cooking, also suitable for complex recipes. The fan is active and the heat comes from below and from above at the same time. Ventilated cooking ensures a faster and more homogeneous result, leaving fragrant foods outside and moister inside. Ideal for baked pasta, biscuits, roasts and cobblers.</p>	 <p>Static: Traditional cooking suitable for the preparation of one dish at a time. The fan is not active and the heat comes from below and from above at the same time. Static cooking is slower and more delicate, ideal in order to get well cooked and dry dishes even inside. Ideal for cooking all types of roasts, fatty meats, bread, filled cakes.</p>
 <p>Circulaire: it is the perfect function for cooking all types of dishes in a more delicate way. The heat comes from the back of the oven and is distributed quickly and evenly The fan is active. It is also ideal for cooking on multiple levels without mixing smells and flavors.</p>	 <p>Grill: Very intense heat coming only from above from a double heating element. The fan is not active. Provides excellent grilling and gratinating results. Used at the end of cooking, it gives a uniform browning to dishes.</p>
 <p>Half grill: For rapid cooking and browning of foods. Best results can be obtained by using the top shelf for small items, the lower shelves for larger ones, such as chops or sausages. For half grill heat is generated only at the centre of the element, so is ideal for smaller quantities.</p>	 <p>Fan grill: very intense heat coming only from above from a double heating element The fan is active. It allows the optimal grilling of thickest meats. Ideal for large cuts of meat.</p>
 <p>Pizza function: Specific function for cooking pizza in a pan. It allows to obtain a pizza that is soft inside and crispy outside with the topping perfectly cooked, not dry and not burnt.</p>	 <p>All glass inner door: All glass inner door, a single flat surface which is simple to keep clean.</p>
 <p>The inner door glass: can be removed with a few quick movements for cleaning.</p>	 <p>Side lights: Two opposing side lights increase visibility inside the oven.</p>



Automatic opening: some models have Automatic opening door when the cycle is finished which is a perfect solution for handle-less kitchen units as no handle is needed. For safety reasons, the door locks automatically when the machine is in use to avoid it being opened inadvertently.



Soft close: all models are equipped with advanced function of smooth closing of the door, which allows the device to close smoothly and quietly.



Vapor Clean: a simple cleaning function using steam to loosen deposits in the oven cavity.



Knobs control



The oven cavity has 5 different cooking levels.



Ultra rapid burners: Powerful ultra rapid burners offer up to 5kw of power.



4.3 inch display with LED technology, usability with knobs + 3 touch keys

## Benefit (TT)

---

### **Gas hob**

Induction offers fast cooking and precise temperature control

Equipped with a thermocouple, the gas supply is cut off if the flame is extinguished for greater safety

### **Touch control**

Easy and intuitive timer setting with a single touch

### **True-convection**

The best cooking performances guaranteed by ventilated circular flow.

Multiple fans and heating elements guarantee the perfect aerodynamic heat flow, allowing homogeneous and quicker cooking inside the cavity.

### **Multilevel cooking**

Several cooking levels allow maximum flexibility of use

### **Multilevel halogen light**

Internal halogen lighting on different levels guarantees excellent visibility

### **Removable inner glass**

Internal door glasses are easily removable for complete cleaning

### **Tangential cooling**

New cooling system with tangential fan and airflow from the door to the splashback

### **Adjustable height**

Cooker top flushed with the working area thanks to adjustable feet

### **Cold door**

During any function, the external door glass is cold, avoiding any risk of burns

### **AirFry (AIRFRY optional accessory)**

Lighter and tastier food thanks to airfry basket

### **Isothermic Cavity**

The best cooking performance at the highest energy efficiency

### **BBQ (optional accessory)**

Barbeque cooking directly in the oven with the double-sided grill

---

**Pizza stone (optional accessory)**

Baking with refractory stone for soft and crispy pizza and yeast products (STONE optional accessory)

**Soft close**

The door is equipped with a specific system for silent closing

**Double Turbine**

The oven has two fans equipped with two circular heating elements allowing cooking with rotating heat