

SPR36UGMX

Cooker size	36"
Hob type	Gas
Type of main oven	Thermo-ventilated
EAN code	8017709316587



Aesthetics











Command panel finish	Stainless steel
Aesthetic	SPR
Logo	Assembled
Colour	Stainless steel
Logo position	Facia below the oven
Finishing	Satin
Upstand	Yes
Serie	Professional

Hob colour	Black enamel
Type of pan stands	Cast Iron
Type of control setting	Control knobs
Control knobs	Smeg new design with knurled ferrule
Controls colour	Stainless steel
Serigraphy colour	Black
Handle	Smeg new design with knurled handle
Handle Colour	Brushed stainless steel

Programs / Functions

No. of cooking functions 8

Traditional cooking functions

 Static	 Fan assisted	 Circulaire
 Small grill	 Large grill	 Fan grill (large)
 Fan assisted bottom	 Pizza	

Other functions

 Defrost by time
--

Cleaning functions

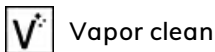

Hob technical features

Total no. of cook zones 6

Front left - 18000 BTU

Rear left - 10000 BTU

Front centre - 10000 BTU

Rear centre - 10000 BTU

Front right - 18000 BTU

Rear right - 10000 BTU

Main Oven Technical Features



No. of lights	2	Removable inner door	Yes
Fan number	2	Total no. of door glasses	3
Gross volume, 1st cavity	4.45 cu. ft.	Cooling system	Tangential
Cavity material	Ever Clean enamel	Lower heating element power	1700 W
No. of shelves	5	Upper heating element - Power	1200 W
Type of shelves	Metal racks	Grill element	1700 W
Light type	Halogen	Large grill - Power	2900 W
Light Power	40 W	Circular heating element - Power	2 x 1550 W
Cooking time setting	Minute minder	Grill type	Electric
Removable door	Yes	Soft Close system	Yes
Full glass inner door	Yes		

Options Main Oven

Minimum Temperature	149 °F	Maximum temperature	500 °F
----------------------------	--------	----------------------------	--------

Accessories included for Main Oven & Hob

Oven grid with stop, tray support	2	Meat Probe	1
--	---	-------------------	---

Electrical Connection

Electrical connection rating	3800 W	Power supply cable length	47 1/4 "
Current	16 A	Frequency	60 Hz
Circuit breaker	20 A	Terminal block	3 poles
Voltage	208/240 V		

Type of electric cable installed

Yes, Double phase

Plug

(B) NEMA 14-50P

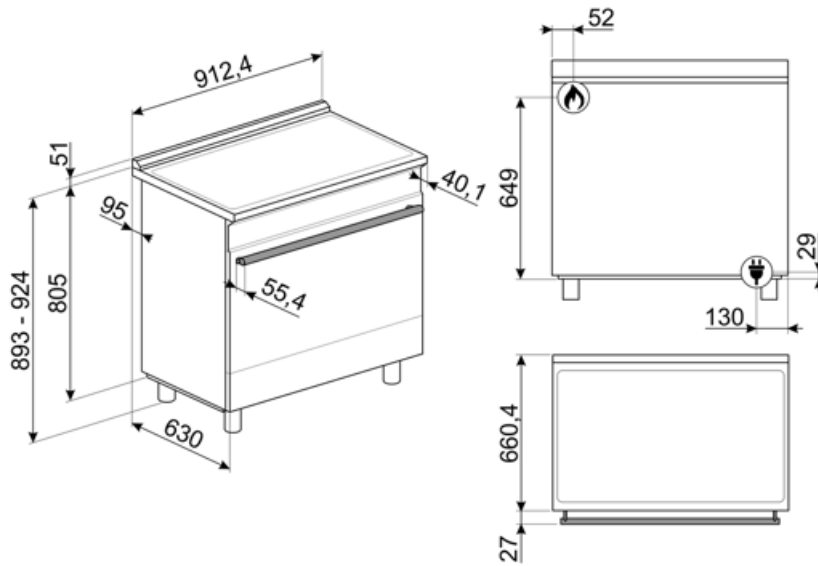

Compatible Accessories



GRM

Coffee machine support



GT3T

Totally extractable telescopic guides

KITBGSPR36X



KITTKSPR36

Plinth, 90cm, three sides, black, suitable for SPR cookers 36"



SFLK1

Child lock

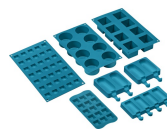

SMOLD

Set of 7 silicone moulds for ice creams, ice lollies, pralines, ice cubes or to portion food. Usable from -60°C to +230°C

STONE9

Rectangular pizza stone, suitable for 90cm wide ovens. Dimensions W64 x H2.3 x D37.5cm. Ideal for cooking pizza with the same aroma and crispness as are typical of a wood-fired oven. Can also be used for baking bread, focaccias and other recipes such as pies and flans or biscuits



















WOKGHU

Cast iron WOK Support



Symbols glossary

 <p>Heavy duty cast iron pan stands: for maximum stability and strength.</p>	 <p>Knobs control</p>
 <p>Air cooling system: to ensure a safe surface temperatures.</p>	 <p>Defrost by time: Manual defrost function. At the end of the set duration, the function stops.</p>
 <p>Triple glazed doors: Number of glazed doors.</p>	 <p>Ever Clean Enamel: Ever Clean enamel is applied electrostatically, corner to corner and edge to edge to prevent cracking or cracks over time. It is a particular pyrolytic enamel, resistant to acids which, in addition to being pleasantly bright, promotes greater cleaning of the oven walls, thanks to its lower porosity. It is baked at over 850 ° C and slowly polymerized at a scientifically determined rate to ensure uniform depth and strength Ever Clean enamel creates an impeccable finish both on the inside of the oven and on the trays, making the surfaces of the oven incredibly easy to maintain over time as it reduces the adhesion of fat during cooking</p>
 <p>Fan assisted base: the mix of fan and lower heating element alone allows to finish cooking foods already cooked on the surface but not internally more quickly. This system is recommended to finish cooking foods that are already well cooked on the surface, but not internally, which therefore require a moderate higher heat. Ideal for any type of food.</p>	 <p>Fan assisted: Intense and homogeneous traditional cooking, also suitable for complex recipes. The fan is active and the heat comes from below and from above at the same time. Ventilated cooking ensures a faster and more homogeneous result, leaving fragrant foods outside and moister inside. Ideal for baked pasta, biscuits, roasts and cobblers.</p>
 <p>Static: Traditional cooking suitable for the preparation of one dish at a time. The fan is not active and the heat comes from below and from above at the same time. Static cooking is slower and more delicate, ideal in order to get well cooked and dry dishes even inside. Ideal for cooking all types of roasts, fatty meats, bread, filled cakes.</p>	 <p>Circulaire: it is the perfect function for cooking all types of dishes in a more delicate way. The heat comes from the back of the oven and is distributed quickly and evenly The fan is active. It is also ideal for cooking on multiple levels without mixing smells and flavors.</p>
 <p>Grill: Very intense heat coming only from above from a double heating element. The fan is not active. Provides excellent grilling and gratinating results. Used at the end of cooking, it gives a uniform browning to dishes.</p>	 <p>Half grill: For rapid cooking and browning of foods. Best results can be obtained by using the top shelf for small items, the lower shelves for larger ones, such as chops or sausages. For half grill heat is generated only at the centre of the element, so is ideal for smaller quantities.</p>
 <p>Fan grill: very intense heat coming only from above from a double heating element The fan is active. It allows the optimal grilling of thickest meats. Ideal for large cuts of meat.</p>	 <p>Pizza function: Specific function for cooking pizza in a pan. It allows to obtain a pizza that is soft inside and crispy outside with the topping perfectly cooked, not dry and not burnt.</p>
 <p>All glass inner door: All glass inner door, a single flat surface which is simple to keep clean.</p>	 <p>The inner door glass: can be removed with a few quick movements for cleaning.</p>



Side lights: Two opposing side lights increase visibility inside the oven.



Automatic opening: some models have Automatic opening door when the cycle is finished which is a perfect solution for handle-less kitchen units as no handle is needed. For safety reasons, the door locks automatically when the machine is in use to avoid it being opened inadvertently.



The oven cavity has 5 different cooking levels.



Soft close: all models are equipped with advanced function of smooth closing of the door, which allows the device to close smoothly and quietly.



Ultra rapid burners: Powerful ultra rapid burners offer up to 5kw of power.



Vapor Clean: a simple cleaning function using steam to loosen deposits in the oven cavity.



4.3 inch display with LED technology, usability with knobs + 3 touch keys