

# SPR30UIMMW

Cooker size	30"
Cavity heat source	ELECTRICITY
Hob type	Induction
Type of main oven	Thermo-ventilated
Cleaning system main oven	Vapor Clean
EAN code	8017709347741



## Aesthetics











<b>Design</b>	Square design	<b>LED colours</b>	Red
<b>Front panel color</b>	Matt white	<b>Control knobs</b>	Smeg new design with knurled ferrule
<b>Command panel finish</b>	Stainless steel	<b>Controls colour</b>	Stainless steel
<b>Logo</b>	Assembled	<b>No. of controls</b>	6
<b>Colour</b>	Matt White	<b>Serigraphy colour</b>	Black
<b>Logo position</b>	Facia below the oven	<b>Display</b>	Touch
<b>Serie</b>	Professional	<b>Handle</b>	Smeg new design with knurled handle
<b>Hob colour</b>	Stainless steel	<b>Handle Colour</b>	Brushed stainless steel
<b>Type of control setting</b>	Control knobs		

## Programs / Functions

No. of cooking functions 8

Traditional cooking functions

 Static	 Fan assisted	 Circulaire
 Small grill	 Large grill	 Fan grill (large)
 Fan assisted bottom	 Pizza	

### Other functions

 Defrost by time
--

## Cleaning functions

 Vapor clean

## Hob options



Multizone Option Yes

## Hob technical features



**Total no. of cook zones** 4

Front left - 1.30 kW - Booster 1.40 kW

Rear left - 2.30 kW - Booster 3.00 kW

Front right - 2.30 kW - Booster 3.00 kW

Rear right - 1.30 kW - Booster 1.40 kW

**No. of cooking zones with Booster** 4

**Number of Flexible zones** 1

**Automatic switch off when overheat** Yes

**Automatic pan detection** Yes

**Selected zone indicator** Yes

**Residual heat indicator** Yes

## Main Oven Technical Features



**No. of lights** 2

**Fan number** 1

**Gross volume, 1st cavity** 4.56 cu. ft.

**Cavity material** Ever Clean enamel

**No. of shelves** 6

**Type of shelves** Metal racks

**Light type** Halogen

**Light Power** 40 W

**Cooking time setting** Minute minder

**Full glass inner door** Yes

**Total no. of door glasses** 3

**Cooling system** Tangential

**Lower heating element power** 1700 W

**Upper heating element - Power** 1200 W

**Grill element** 1700 W

**Large grill - Power** 2900 W

**Circular heating element - Power** 2700 W

**Grill type** Electric

**Soft Close system** Yes

## Options Main Oven

**Minimum Temperature** 151 °F

**Maximum temperature** 500 °F

## Accessories included for Main Oven & Hob

Oven grid with stop,  
tray support 2

Meat Probe 1

## Electrical Connection

Circuit breaker 50 A  
Voltage 208/240 V  
Type of electric cable installed Yes, Double phase

Power supply cable length 47 1/4 "  
Frequency 60 Hz  
Terminal block 3 poles

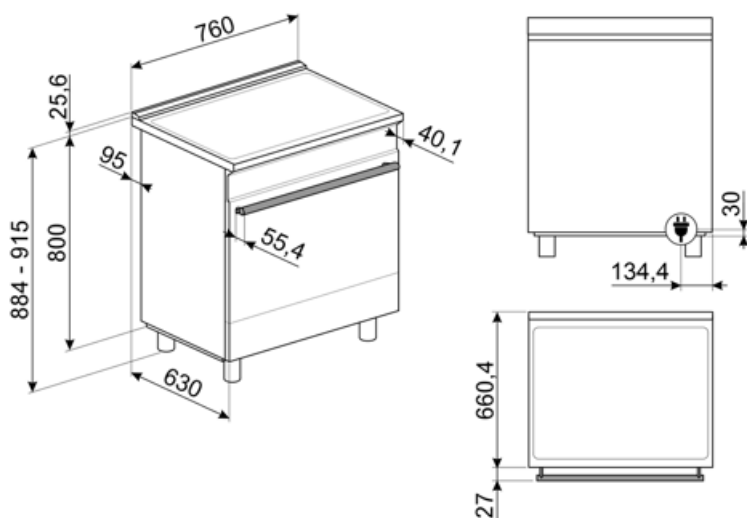

## Compatible Accessories

### AIRFRY9

Air fryer rack AIRFRY . Ideal for recreating traditional frying in the oven, but with fewer calories and less fat. It allows you to cook quickly and simply dishes such as French fries, fried vegetables and fish, ensuring perfect browning and crispiness.



### BN920

Enamelled tray 90cm cavity, 20mm deep



### GRILLPLATE

Universal griddle for induction, gas, ceramic and electric hobs. Non-stick surface ideal for cooking meat, cheese and vegetables. Dimensions: 410 x 240 mm.



### KITTKSPR30

Plinth, 90cm, three sides, black, suitable for SPR cookers 30"



### SCRP

Non-scratch hob scraper - suitable for induction and ceramic hobs



### STONE2

Rectangular pizza stone without handles, suitable for 45cm and 60cm wide ovens. Dimensions W42 x H1.8 x D37.5cm. Ideal for cooking pizzas with the same results as a typical wood-fired oven. Can also be used for baking bread, focaccias and other recipes such as pies, flans or biscuits



### BBQ9

teflon-coated aluminum grid for 90 cm cavity



### BN940

Enamelled tray 90 cm, 40 mm deep



### GT3T

Totally extractable telescopic guides



### PALPZ

Pizza shovel with folding handle. Dimensions L31.5 x H32.5 cm. Easy and convenient to use and store. Perfect for serving pizza, bread and savory pastries in a safe and professional way.



### SFLK1

Child lock



### TPKPLATE

Universal plate for induction, gas, ceramic and electric hobs. Non-stick surface ideal for cooking fish, eggs and vegetables. Dimensions: 410 X 240 mm.



---

## Alternative products

---



**SPR30UIMANX**  
Colour: Matt Black





















**SPR30UIMX**  
Colour: Stainless steel



**SPR30UIMAN**  
Colour: Matt Black

## Symbols glossary

 <p>Automatic merge of zones for a bigger area</p>	 <p>Power booster: option allows the zone to work at full power when very intense cooking is necessary.</p>
 <p>A: Product drying performance, measured from A+++ to D / G depending on the product family</p>	 <p>Knobs control</p>
 <p>Air cooling system: to ensure a safe surface temperatures.</p>	 <p>Defrost by time: Manual defrost function. At the end of the set duration, the function stops.</p>
 <p>4.3 inch display with LED technology, usability with knobs + 3 touch keys</p>	 <p>Triple glazed doors: Number of glazed doors.</p>
 <p>Ever Clean Enamel: Ever Clean enamel is applied electrostatically, corner to corner and edge to edge to prevent cracking or cracks over time. It is a particular pyrolytic enamel, resistant to acids which, in addition to being pleasantly bright, promotes greater cleaning of the oven walls, thanks to its lower porosity. It is baked at over 850 ° C and slowly polymerized at a scientifically determined rate to ensure uniform depth and strength Ever Clean enamel creates an impeccable finish both on the inside of the oven and on the trays, making the surfaces of the oven incredibly easy to maintain over time as it reduces the adhesion of fat during cooking</p>	 <p>Fan assisted base: the mix of fan and lower heating element alone allows to finish cooking foods already cooked on the surface but not internally more quickly. This system is recommended to finish cooking foods that are already well cooked on the surface, but not internally, which therefore require a moderate higher heat. Ideal for any type of food.</p>
 <p>Fan assisted: Intense and homogeneous traditional cooking, also suitable for complex recipes. The fan is active and the heat comes from below and from above at the same time. Ventilated cooking ensures a faster and more homogeneous result, leaving fragrant foods outside and moister inside. Ideal for baked pasta, biscuits, roasts and cobblers.</p>	 <p>Static: Traditional cooking suitable for the preparation of one dish at a time. The fan is not active and the heat comes from below and from above at the same time. Static cooking is slower and more delicate, ideal in order to get well cooked and dry dishes even inside. Ideal for cooking all types of roasts, fatty meats, bread, filled cakes.</p>
 <p>Circulaire: it is the perfect function for cooking all types of dishes in a more delicate way. The heat comes from the back of the oven and is distributed quickly and evenly The fan is active. It is also ideal for cooking on multiple levels without mixing smells and flavors.</p>	 <p>Grill: Very intense heat coming only from above from a double heating element. The fan is not active. Provides excellent grilling and gratinating results. Used at the end of cooking, it gives a uniform browning to dishes.</p>
 <p>Half grill: For rapid cooking and browning of foods. Best results can be obtained by using the top shelf for small items, the lower shelves for larger ones, such as chops or sausages. For half grill heat is generated only at the centre of the element, so is ideal for smaller quantities.</p>	 <p>Fan grill: very intense heat coming only from above from a double heating element The fan is active. It allows the optimal grilling of thickest meats. Ideal for large cuts of meat.</p>
 <p>Pizza function: Specific function for cooking pizza in a pan. It allows to obtain a pizza that is soft inside and crispy outside with the topping perfectly cooked, not dry and not burnt.</p>	 <p>Overheat protection: The safety system that automatically turns off the hob in case of overheating of the control unit.</p>



**Induction:** The work of these hobs is based on the principle of electromagnetic induction. The heat is generated directly in the bottom of the pan during its contact with the hob.



**All glass inner door:** All glass inner door, a single flat surface which is simple to keep clean.



**Side lights:** Two opposing side lights increase visibility inside the oven.



**Automatic opening:** some models have Automatic opening door when the cycle is finished which is a perfect solution for handle-less kitchen units as no handle is needed. For safety reasons, the door locks automatically when the machine is in use to avoid it being opened inadvertently.



**Indication of residual heat:** After the glass ceramic hob is switched off the residual heat indicator shows which of the heating zones still remains hot. When the temperature drops below 60 ° C, the indicator goes out.



The oven cavity has 6 different cooking levels.



**Soft close:** all models are equipped with advanced function of smooth closing of the door, which allows the device to close smoothly and quietly.



**Vapor Clean:** a simple cleaning function using steam to loosen deposits in the oven cavity.



The capacity indicates the amount of usable space in the oven cavity in litres.