

Modèle / Model:

907-60

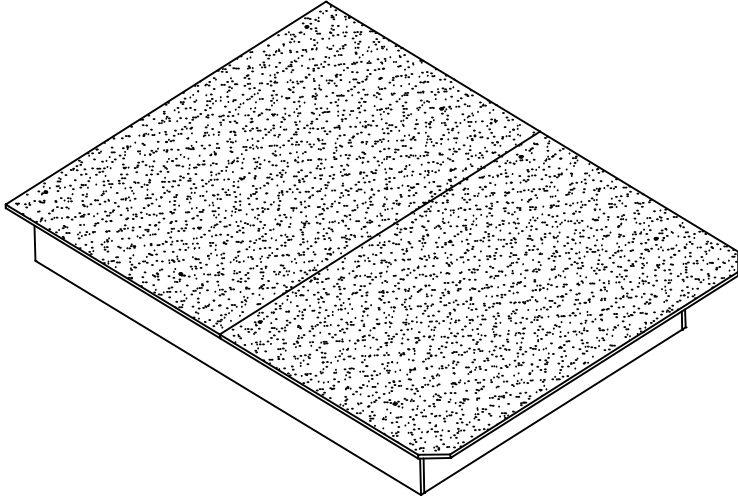



Plan de montage
Assembling instruction

27-08-2024



Fabriqué et imprimé au Canada/Made and printed in Canada

1/2

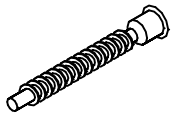
Code	Quincaillerie / Hardware	Qté / Qty
#973	FERRURE D'ASSEMBLAGE KNOCK DOWN FITTING 	8
	DOUILLE DOWEL 	8
#902	SOUS PATTE GLIDE 	10
#031	GOUJON DE BOIS WOODEN DOWEL 	4
#002	VIS CONFIRMAT 5MM SCREW 5MM CONFIRMAT 	8

Étape / Step #1

LISTE DES PIÈCES / PART LIST

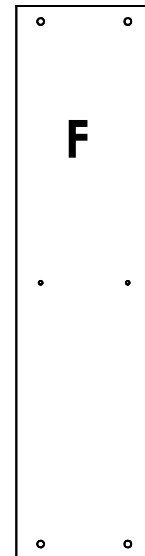
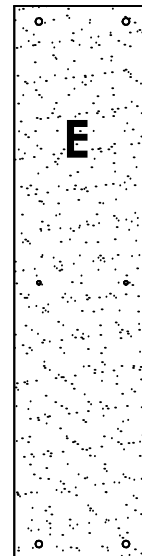
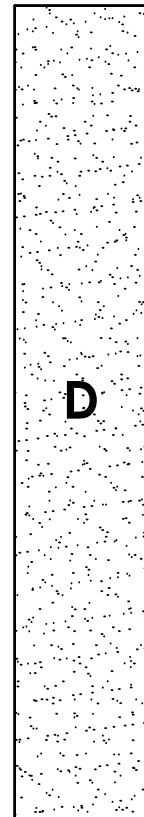
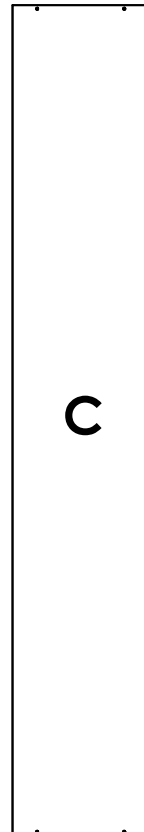
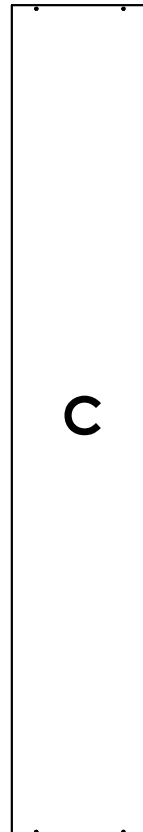
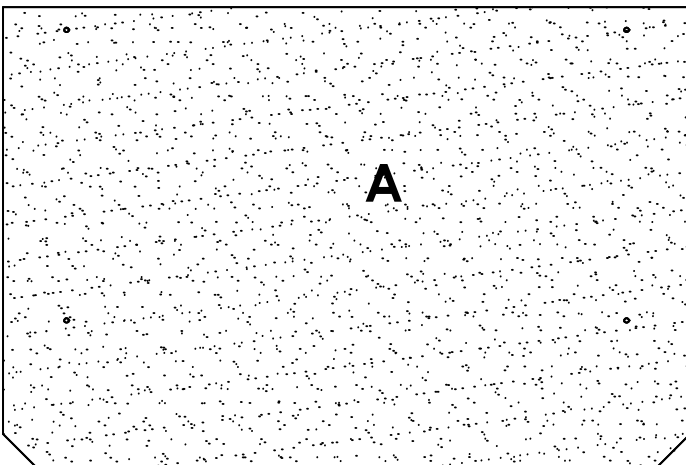
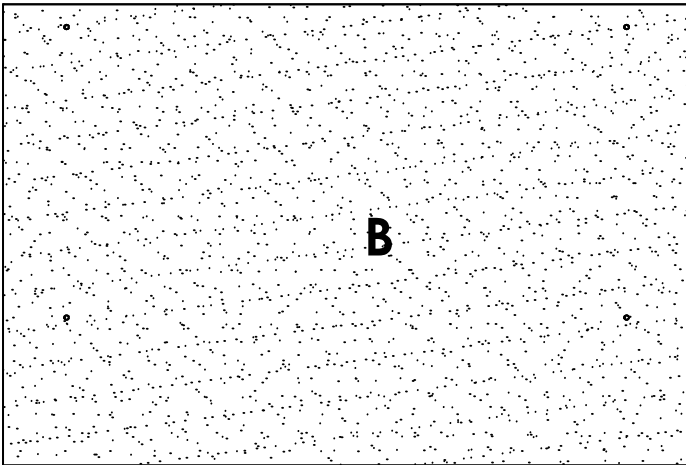

Étape / Step #2

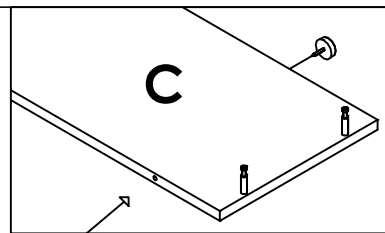
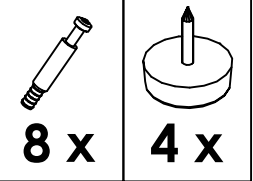

Trous de ce côté
Holes this side

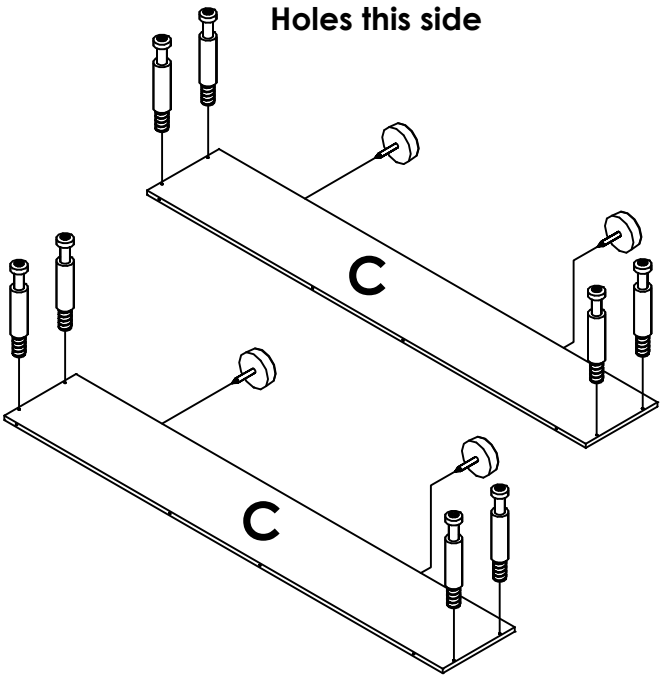

Étape / Step #3

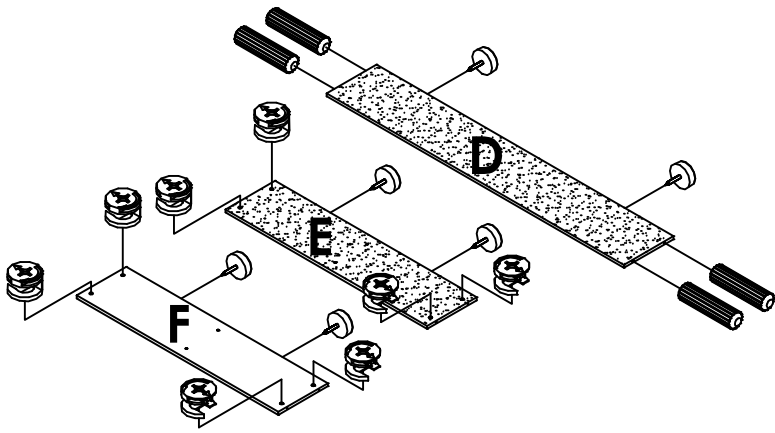
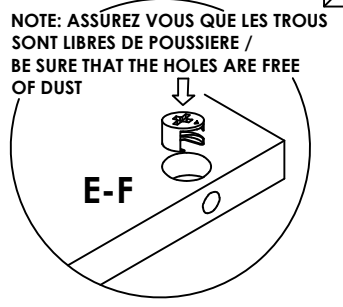
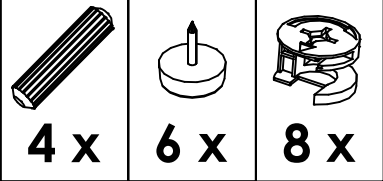

Étape / Step #4

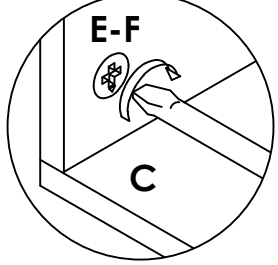

Important
Trous vers le haut
Holes up

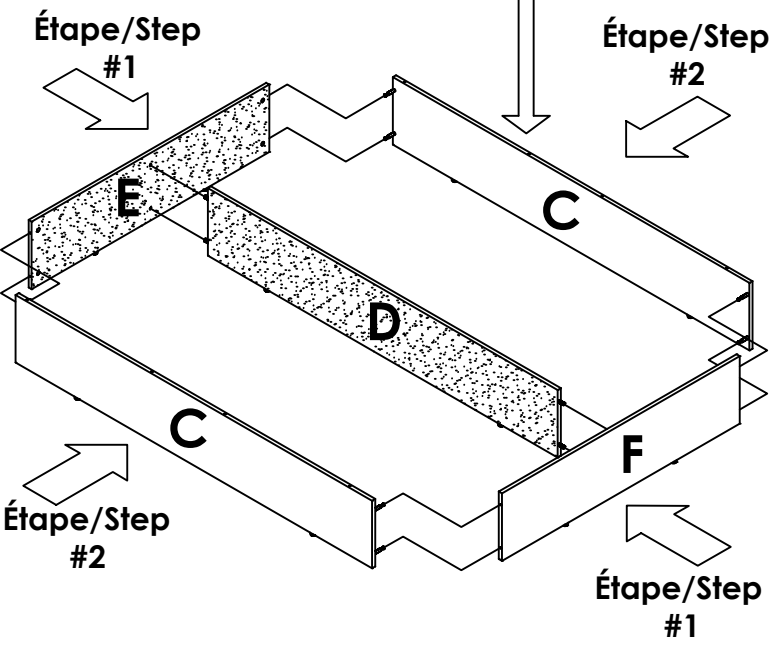

Étape / Step #5

