

meubles
**Nouveau
Concept**.ca
furniture

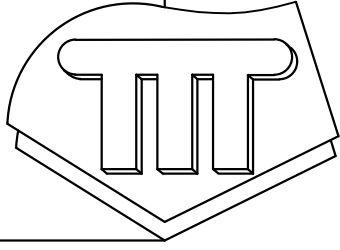

Modèle / Model:

929-80

Fabriqué et imprimé au Canada/Made and printed in Canada

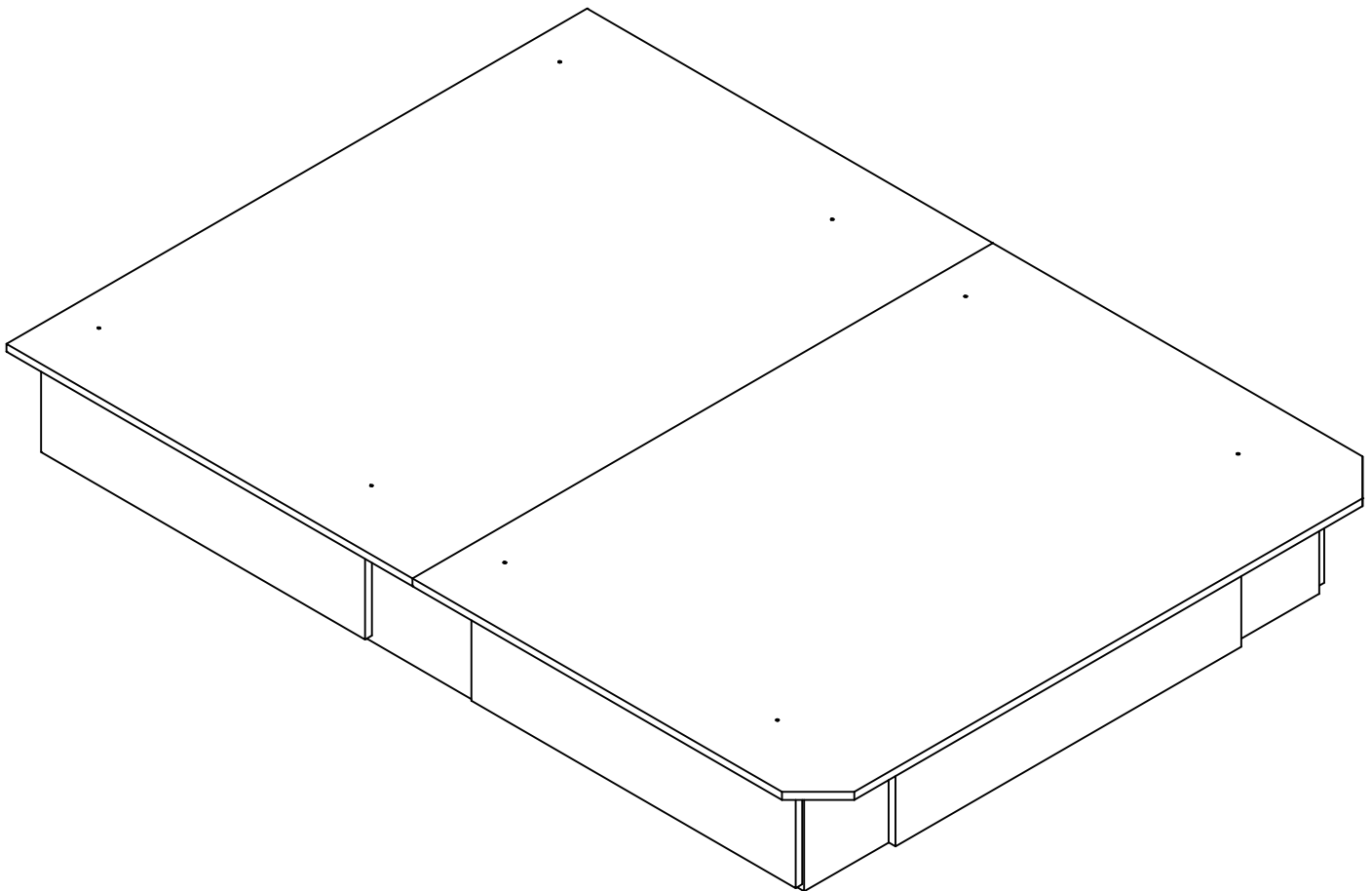

ASSEMBLAGE PLATEFORME 4 TIROIRS 4 DRAWERS PLATFORM ASSEMBLING

Étape / Step #1

LISTE DES PIÈCES / PART LIST

BOITE / BOX 1/4

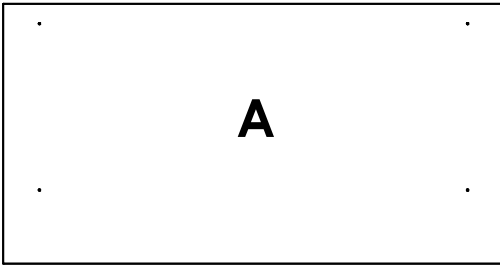

A

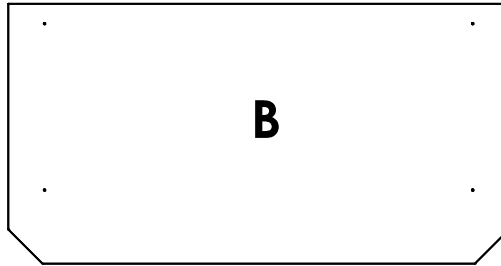

B

BOITE / BOX 2/4

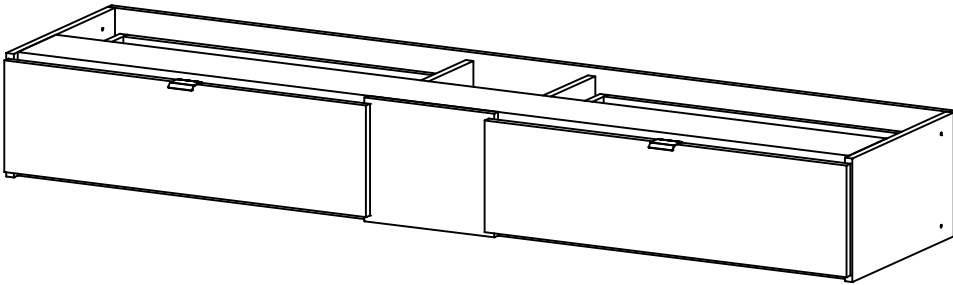

VOUS N'UTILISEREZ PAS LA PIÈCE "C".
YOU WILL NOT USE "C" PART.

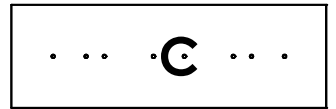

BOITE / BOX 3/4

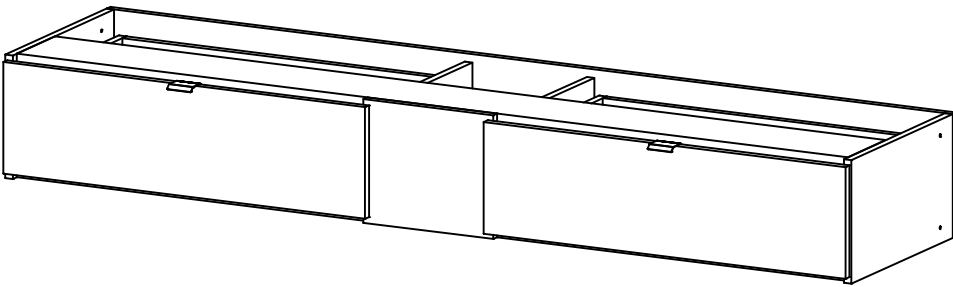

VOUS N'UTILISEREZ PAS LA PIÈCE "C".
YOU WILL NOT USE "C" PART.

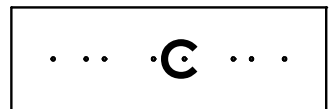

J



L



K



M

BOITE / BOX 4/4

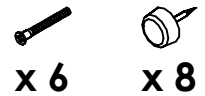

Étape / Step #2

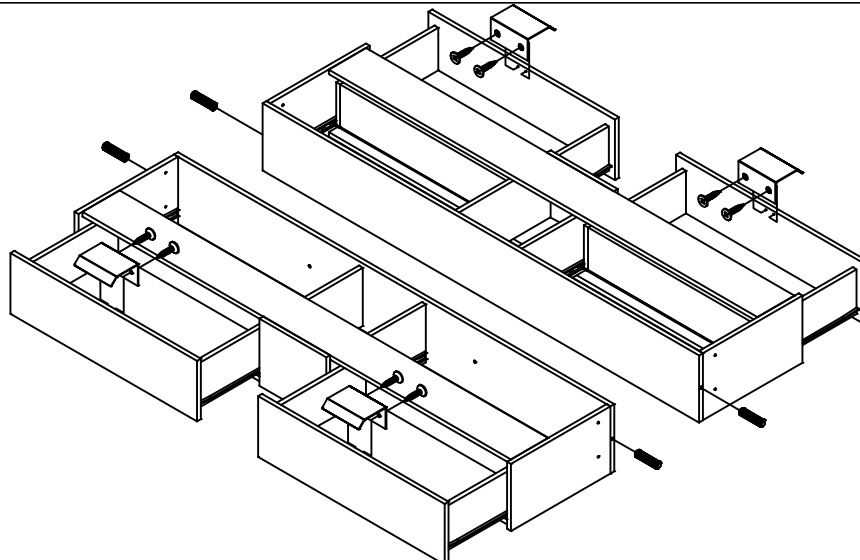
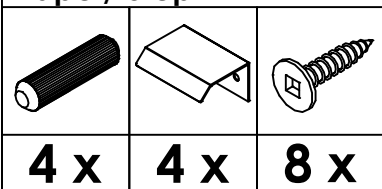

Étape / Step #3



8 x

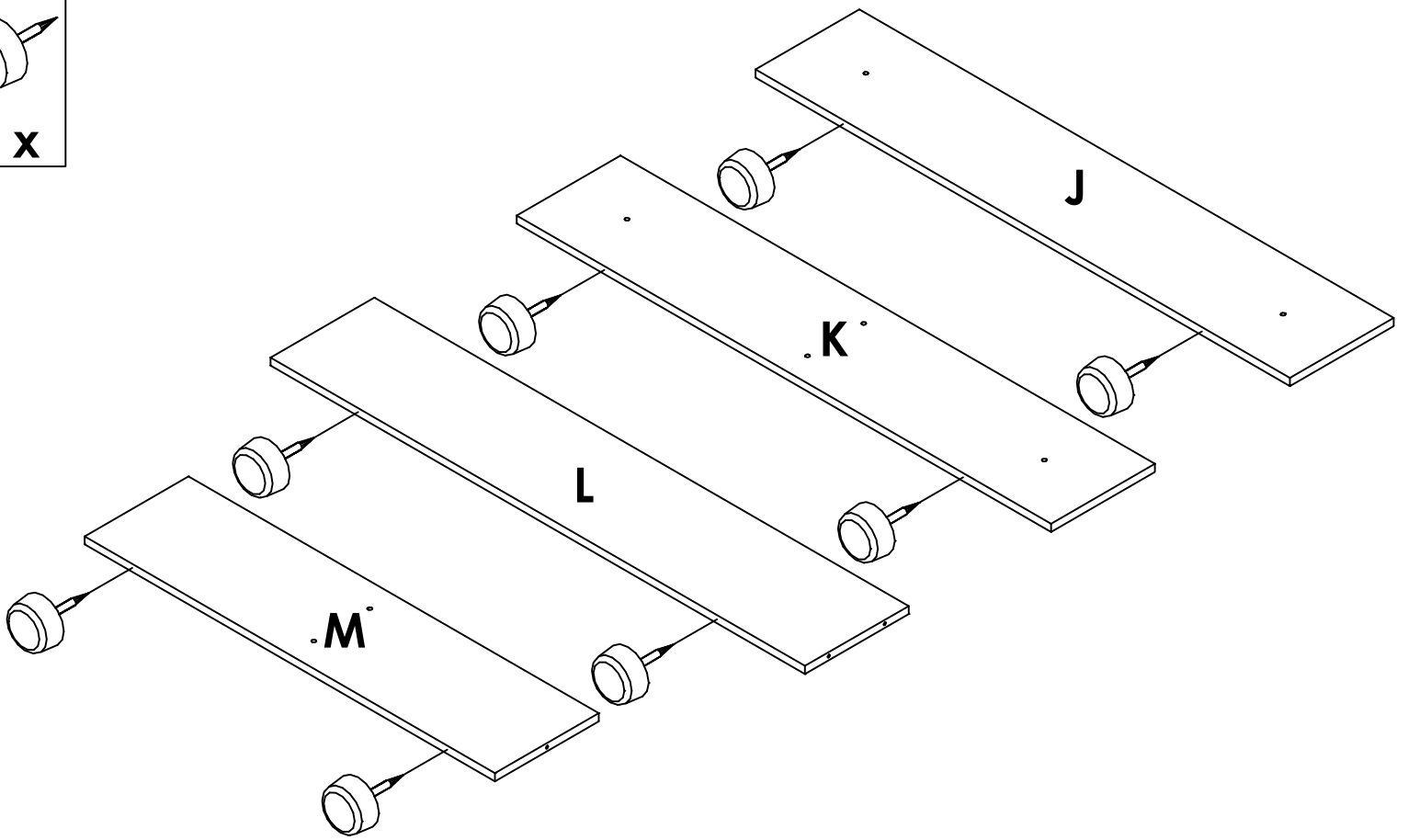

Étape / Step #4

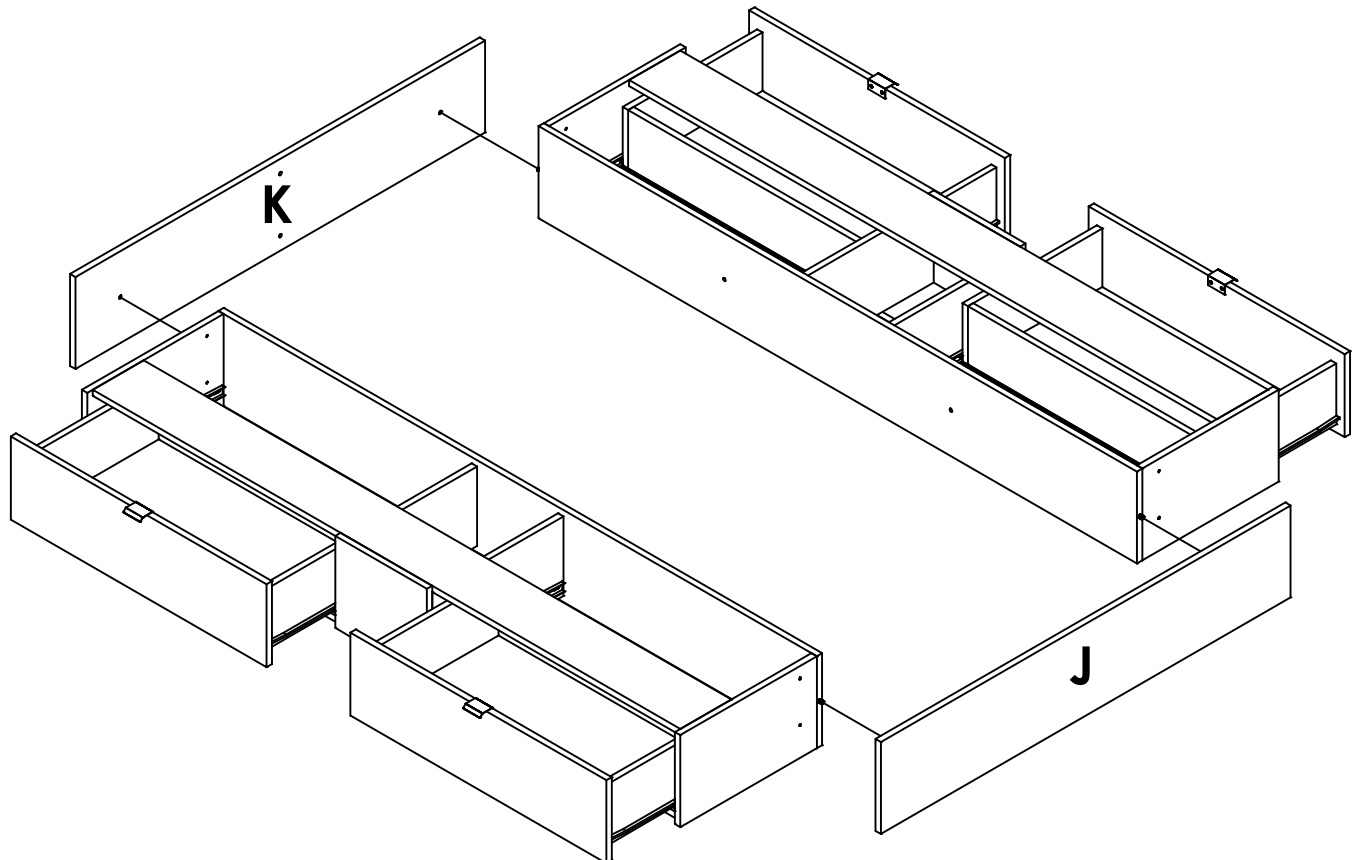

Étape / Step #5

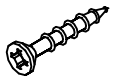

8 x

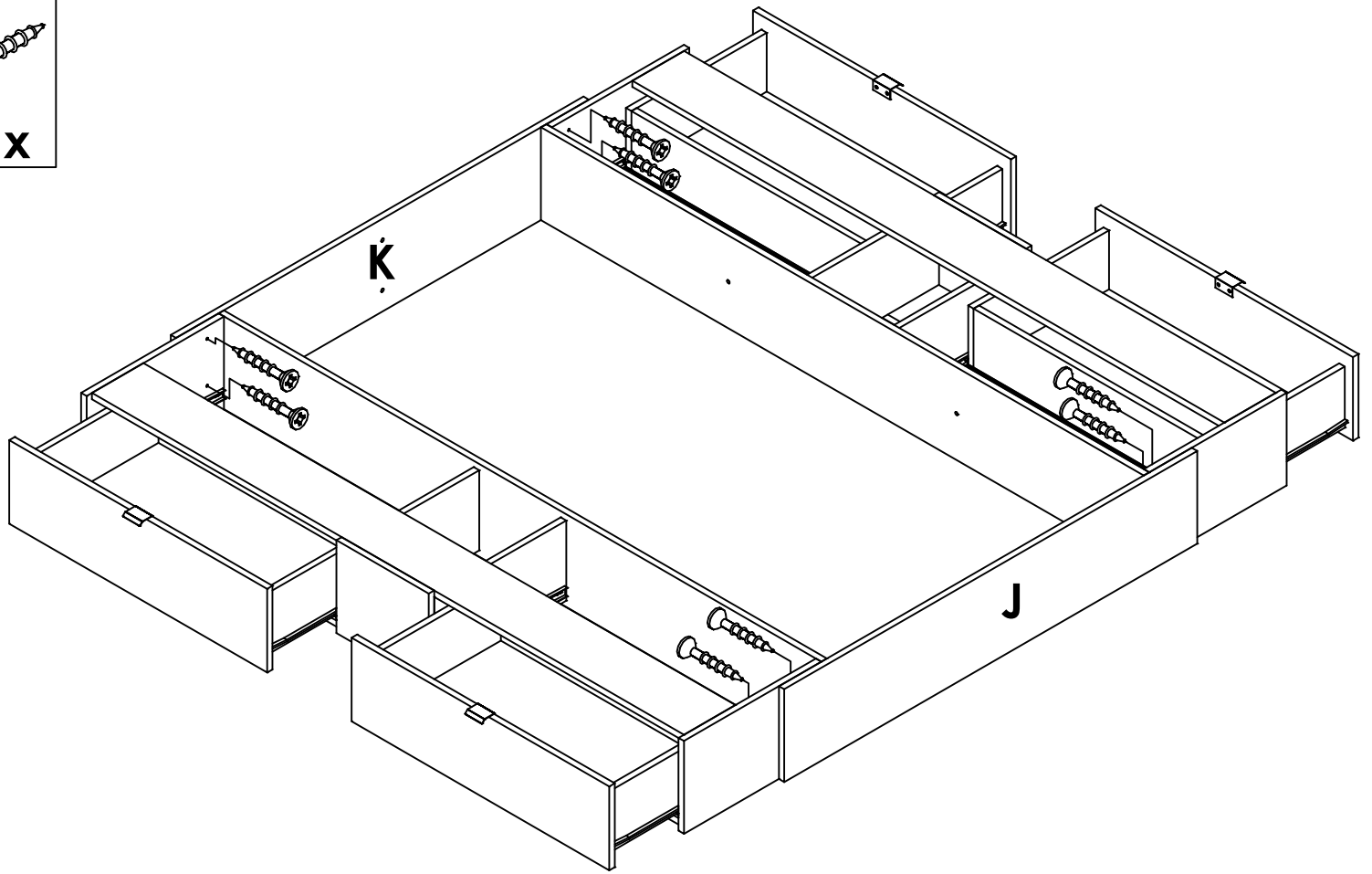

Étape / Step #6



4 x

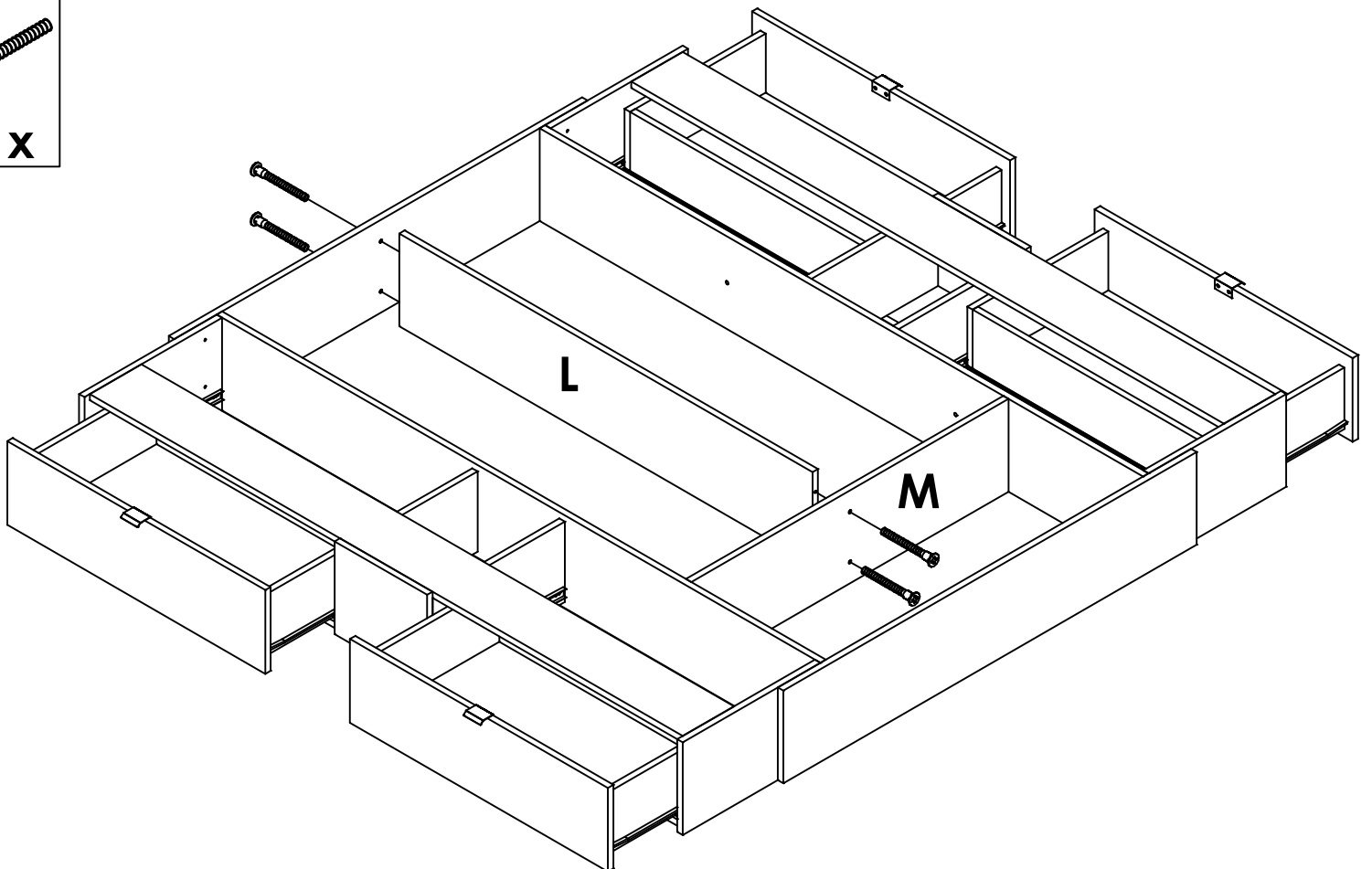

Étape / Step #7



2 x

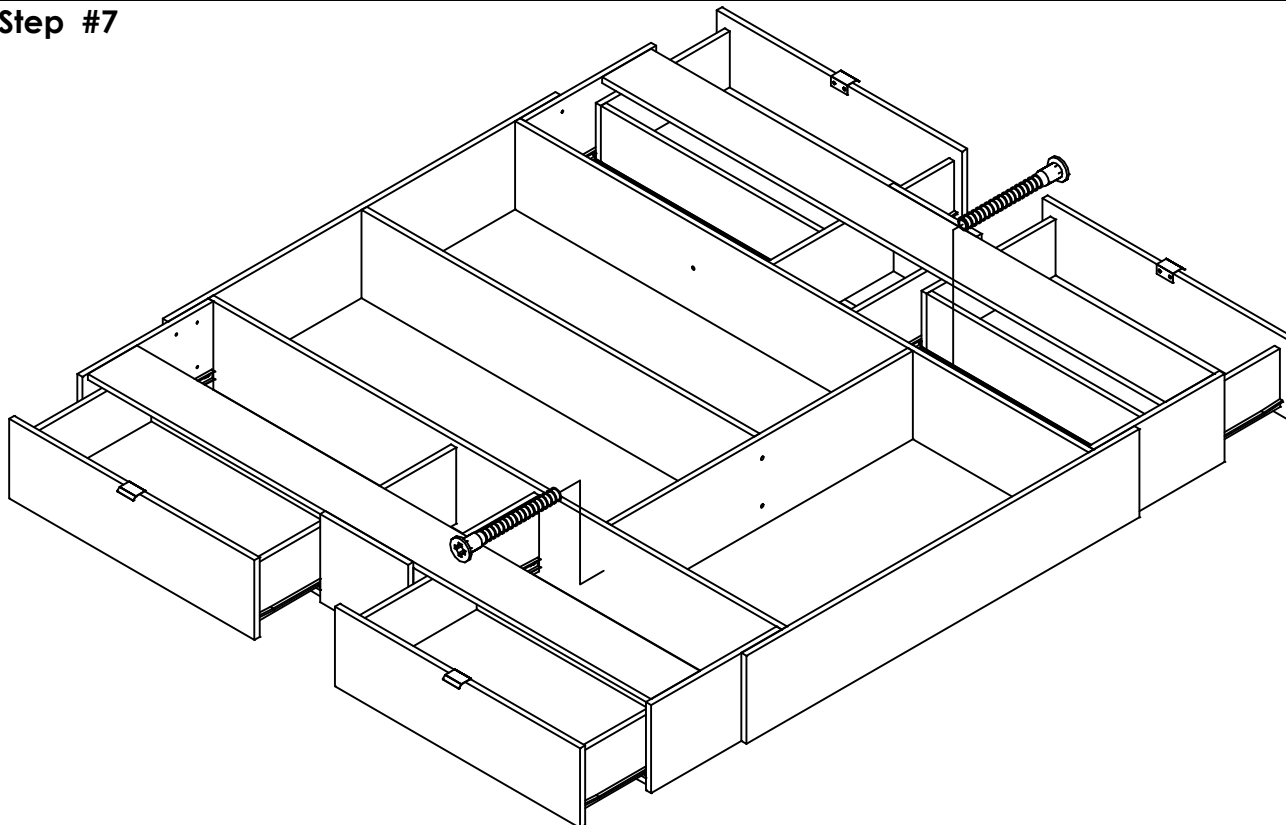

SI VOUS VOUS ÊTES PROCURÉS UNE DE NOS TÊTES DE LIT,
FIXEZ CELLE-CI À VOTRE PLATE-FORME AVANT D'EFFECTUER L'ÉTAPE #8.

IF YOU HAVE BOUGHT ONE OF OUR HEADBOARDS,
ATTACH IT TO YOUR PLATFORM BEFORE DOING STEP #8.

Étape / Step #8

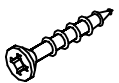

8 x

VEUILLEZ POSITIONNER VOTRE PLATEFORME DANS
LA PIÈCE AVANT D'INSTALLER LE DESSUS.

PLEASE PLACE YOUR PLATFORM IN THE ROOM
BEFORE INSTALLING THE TOP.

