

meubles
**Nouveau
Concept**.
furniture

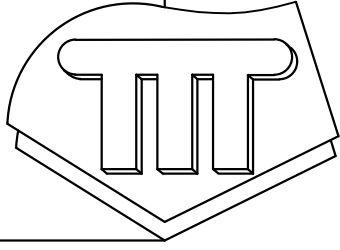

Modèle / Model:

933-39XL

Fabriqué et imprimé au Canada/Made and printed in Canada

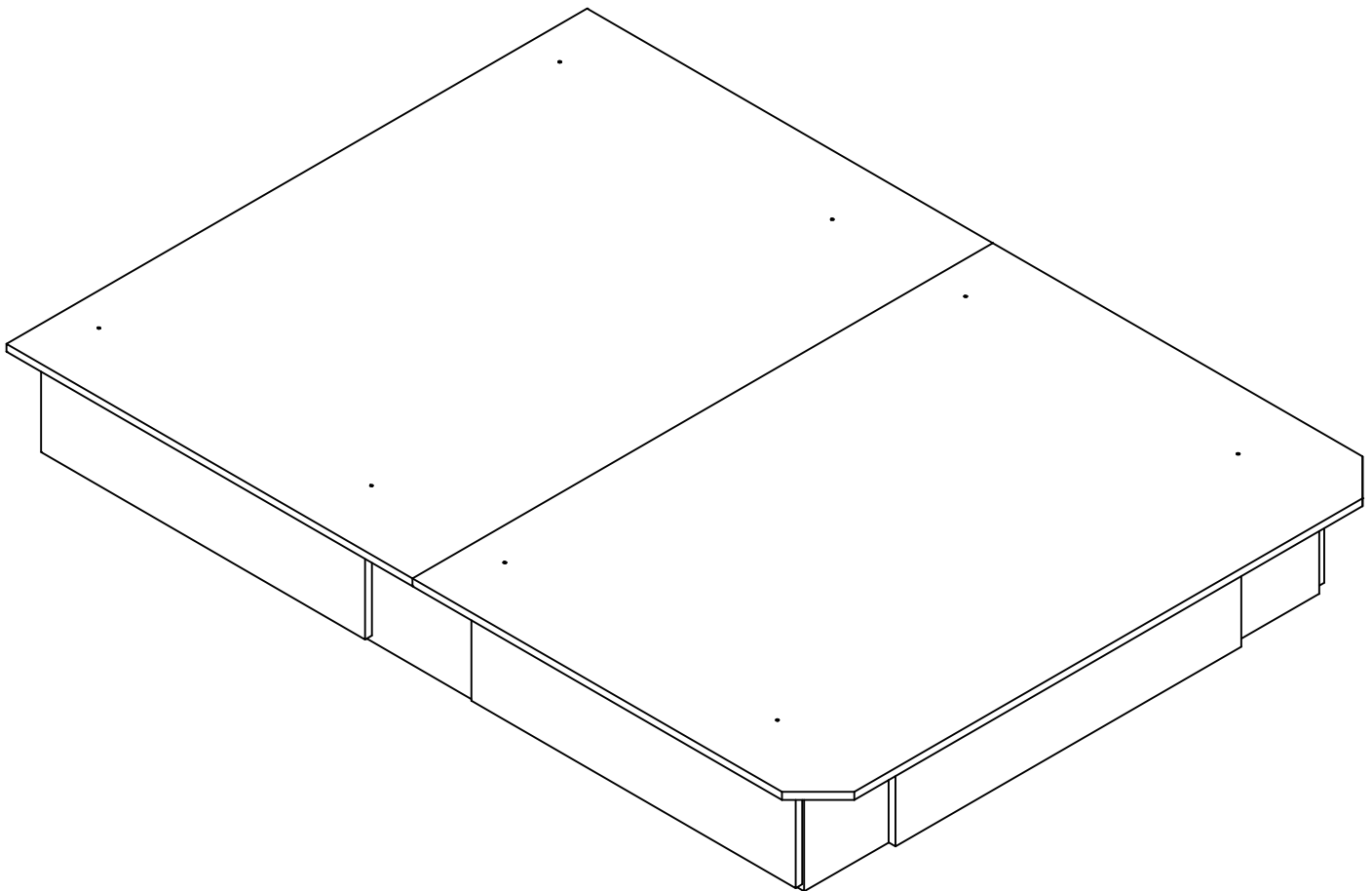

ASSEMBLAGE PLATEFORME 2 TIROIRS 2 DRAWERS PLATFORM ASSEMBLING

Étape / Step #1

LISTE DES PIÈCES / PART LIST

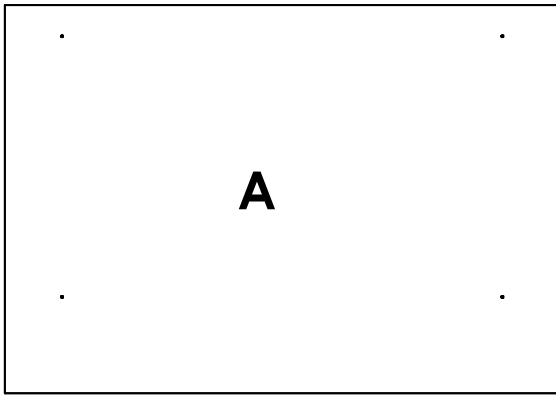

A

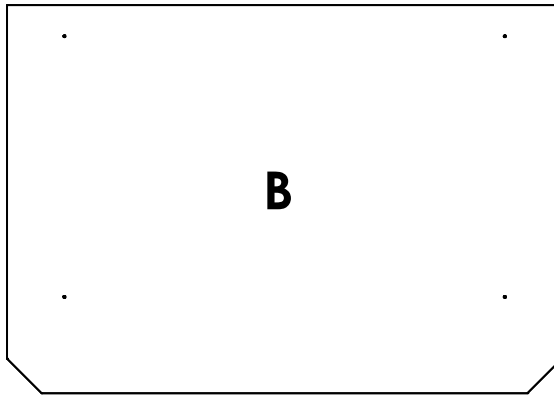

B

BOITE / BOX 1/3

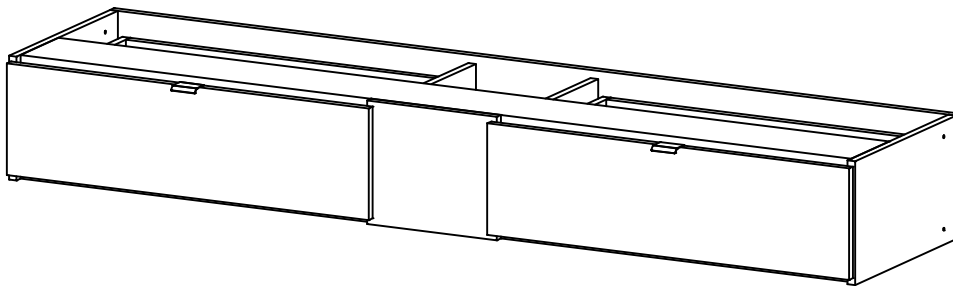

BOITE / BOX 2/3



x 2

x 2

x 4

x 8

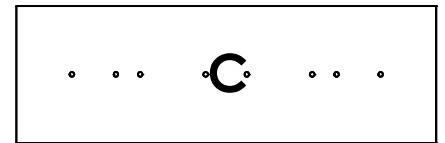

D



E



F

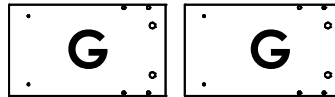

G

G



H

BOITE / BOX 3/3

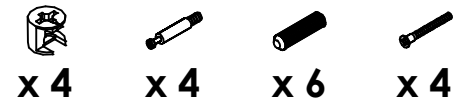

x 4

x 4

x 6

x 4

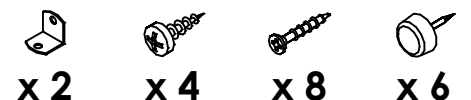

x 2

x 4

x 8

x 6

Étape / Step #2

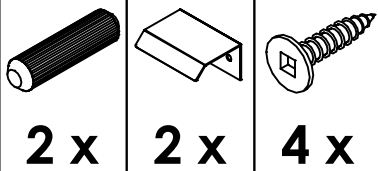

2 x

2 x

4 x

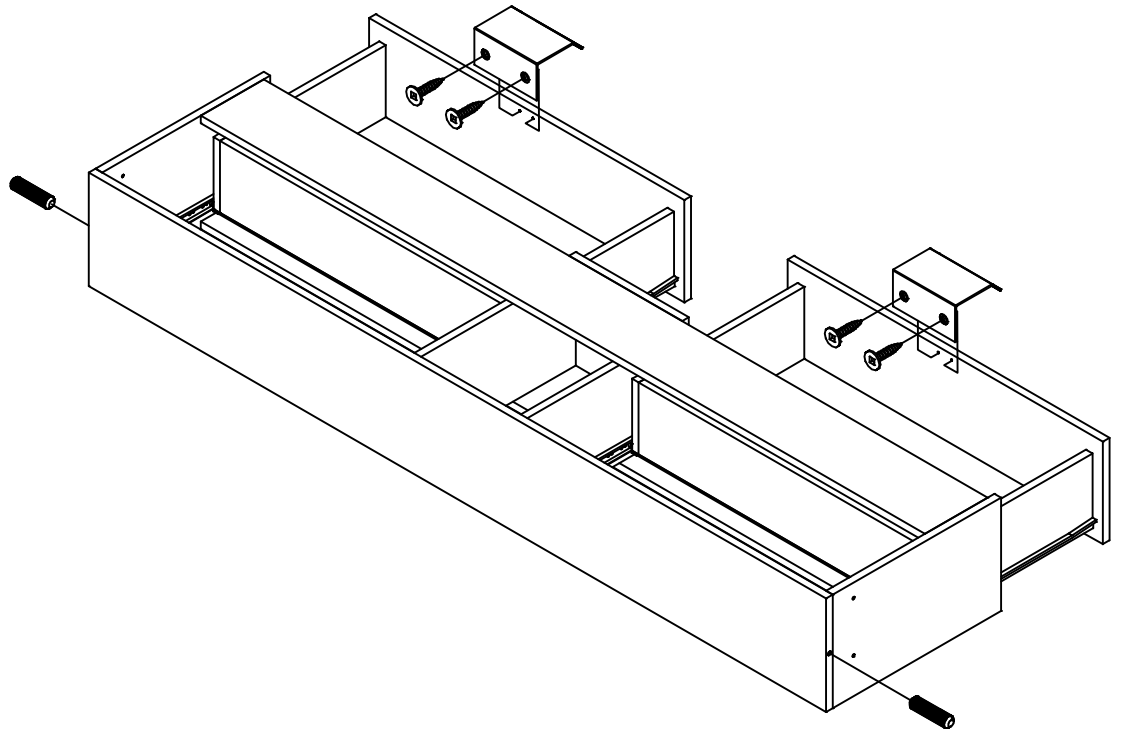

Étape / Step #3



NOTE: ASSUREZ VOUS QUE LES TROUS
SONT LIBRES DE POUSSIERE /
BE SURE THAT THE HOLES ARE FREE
OF DUST

4 x

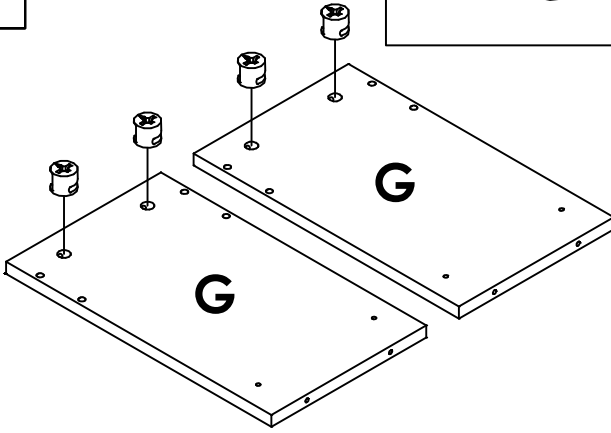

Étape / Step #4

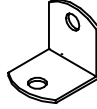

2 x

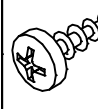

2 x

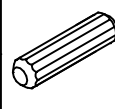

4 x

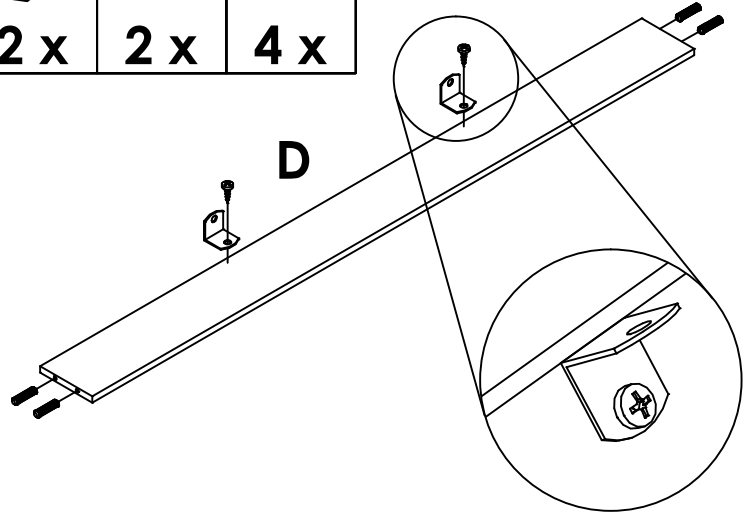

Étape / Step #5

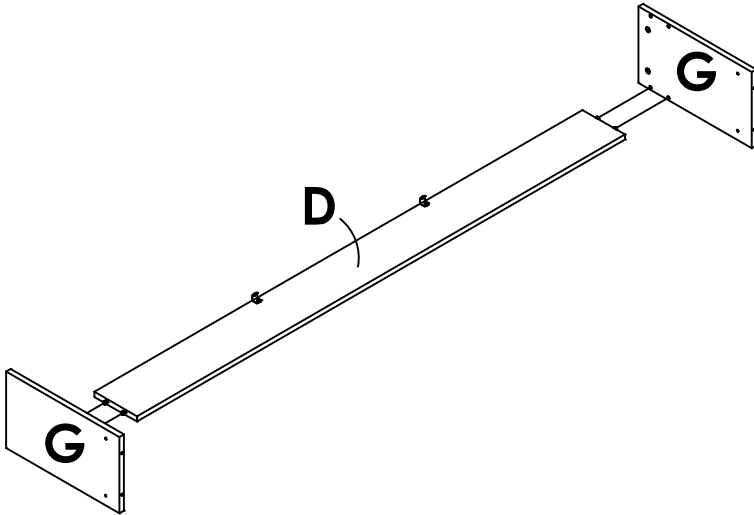

Étape / Step #6



4 x



2 x



6 x

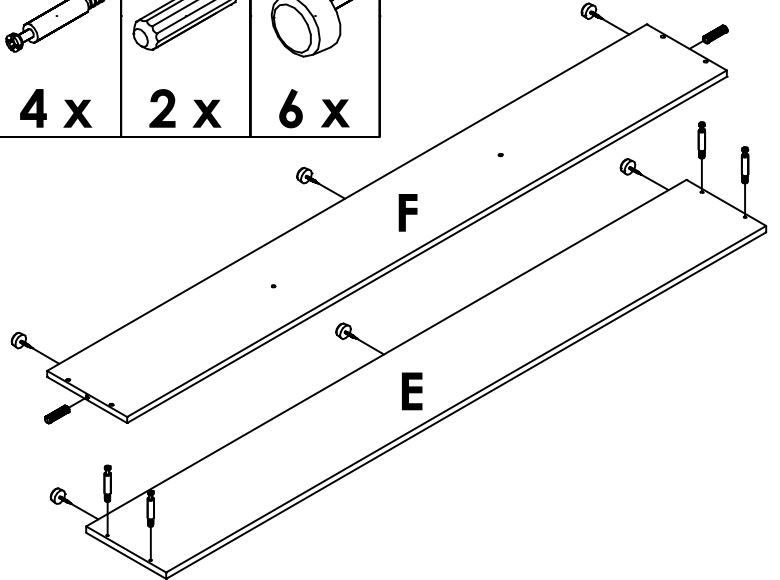

Étape / Step #7

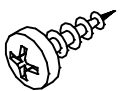

2 x

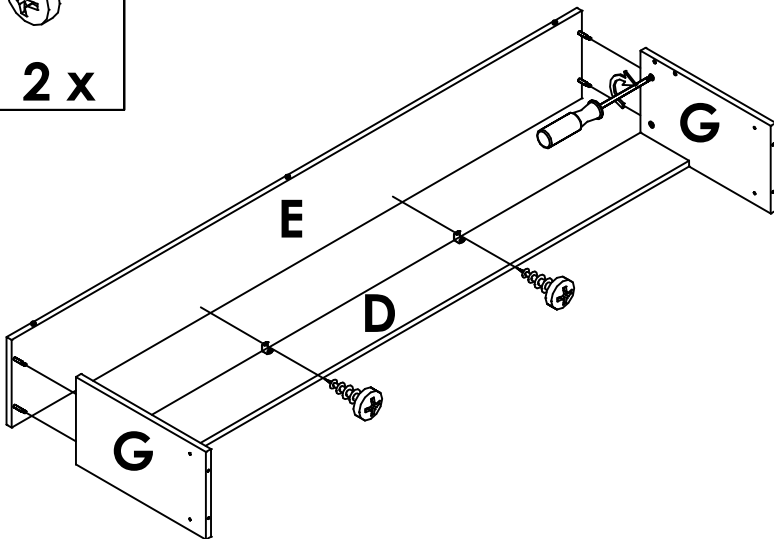

Étape / Step #8



4 x

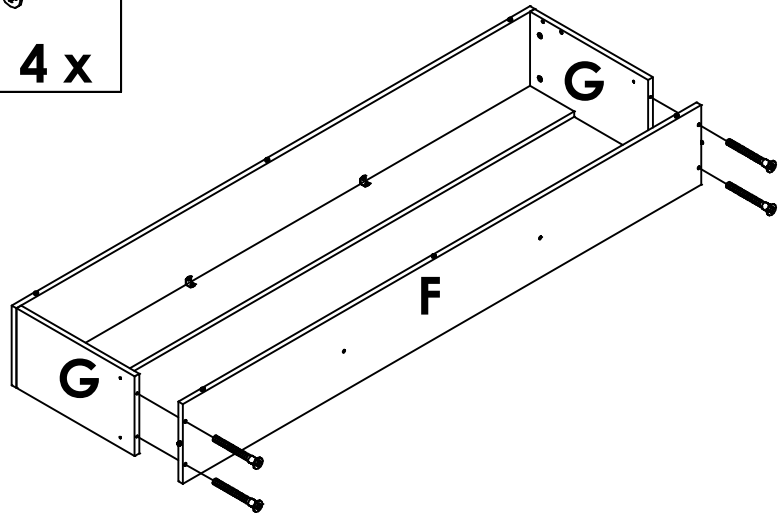

POUR TIROIRS À GAUCHE / FOR DRAWERS ON LEFT SIDE

Étape / Step #9

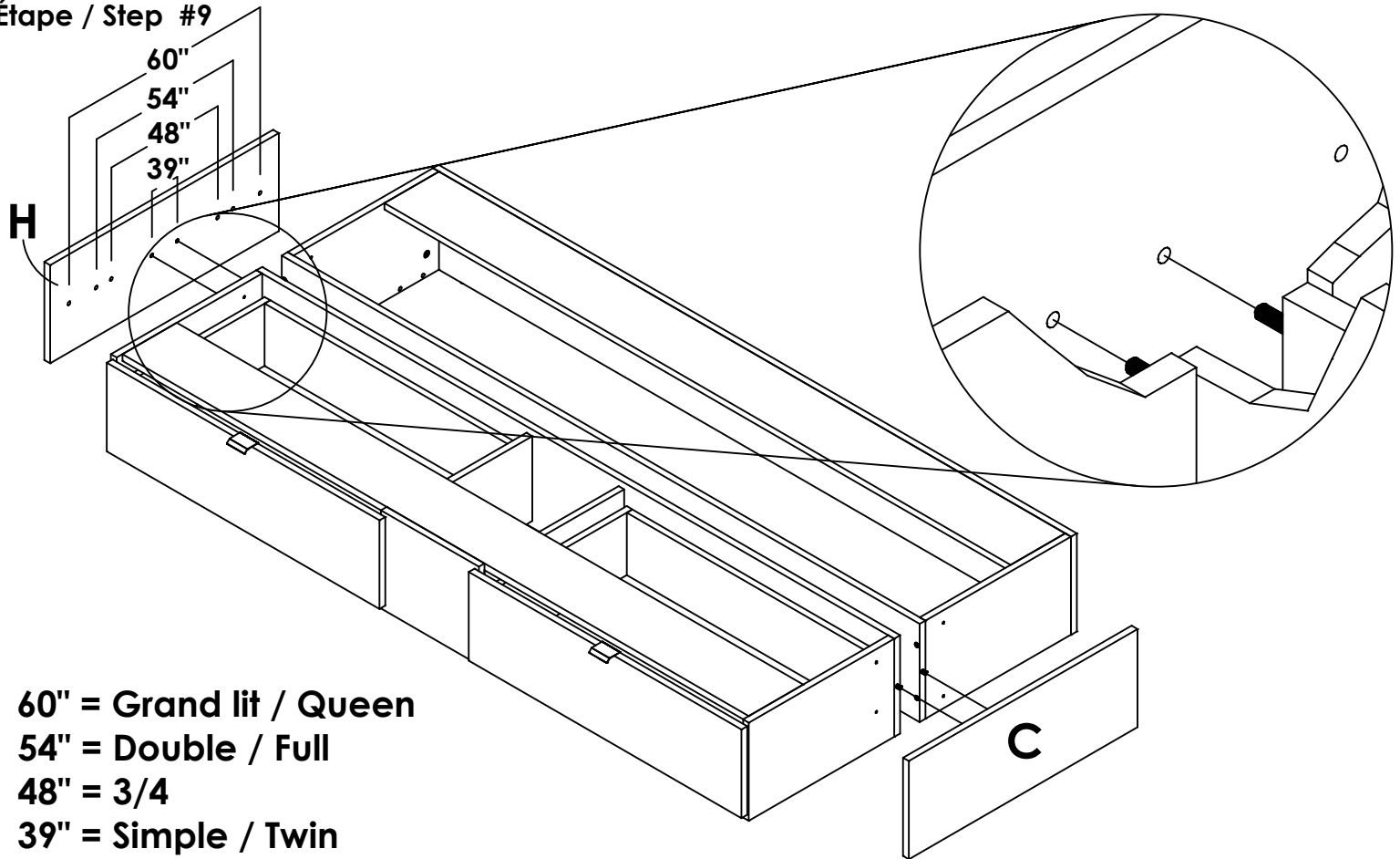

60" = Grand lit / Queen
54" = Double / Full
48" = 3/4
39" = Simple / Twin

POUR TIROIRS À DROITE / FOR DRAWERS ON RIGHT SIDE

Étape / Step #9

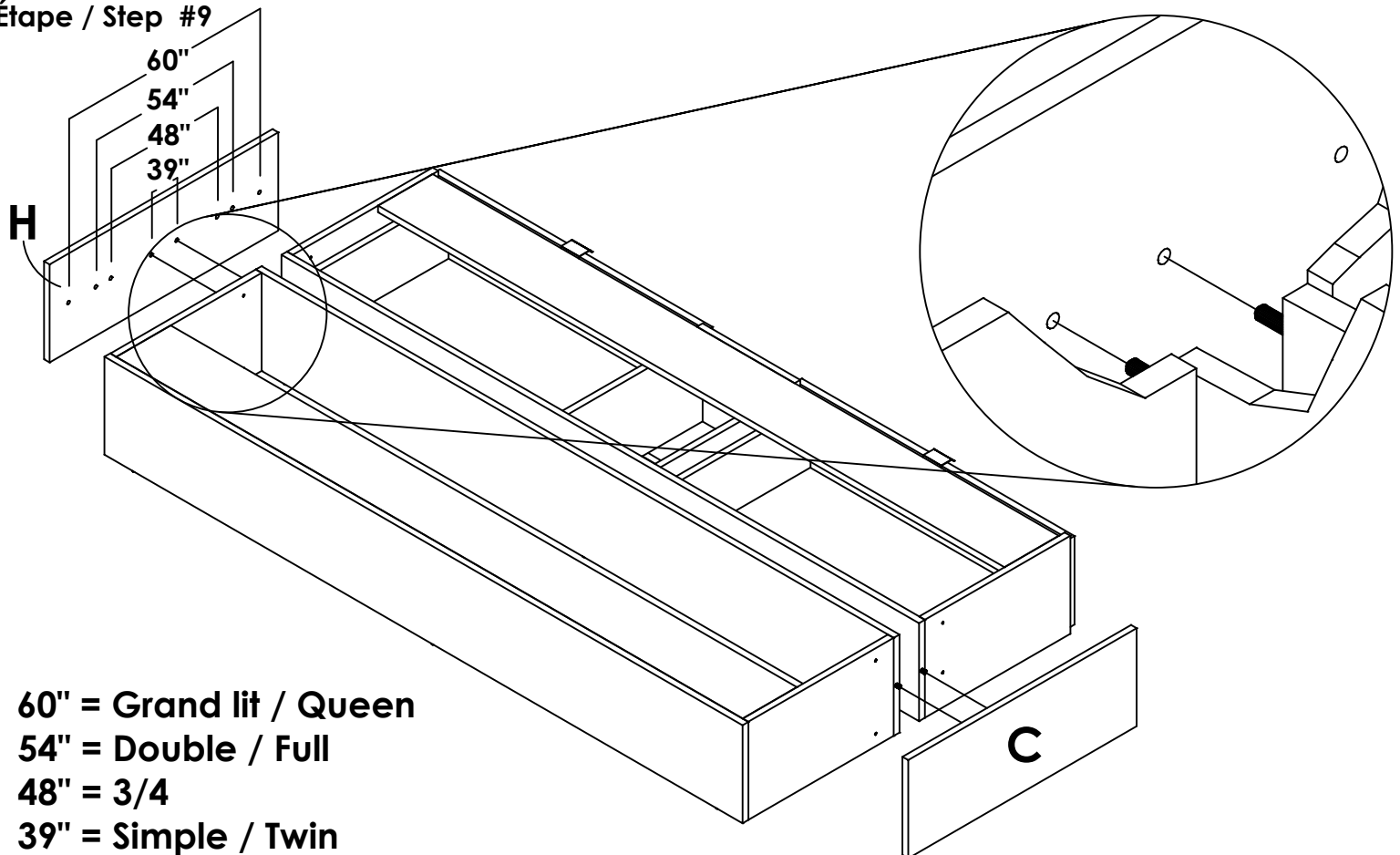

60" = Grand lit / Queen
54" = Double / Full
48" = 3/4
39" = Simple / Twin

Étape / Step #10

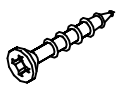

8 x

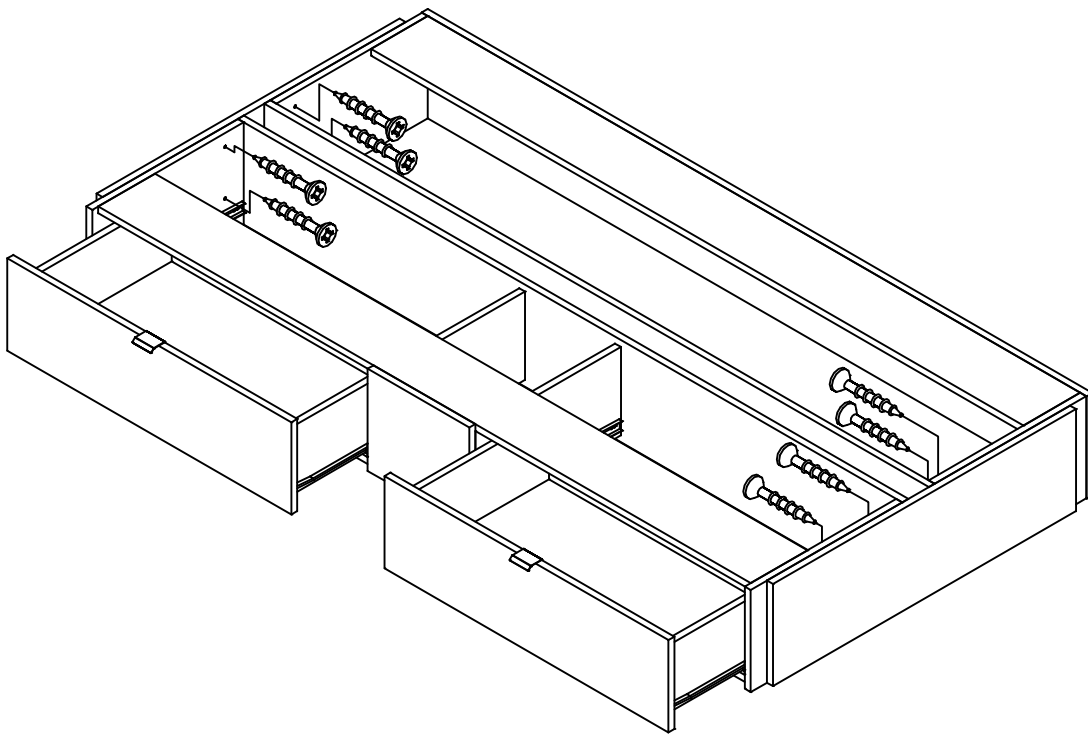

**SI VOUS VOUS ÊTES PROCURÉS UNE DE NOS TÊTES DE LIT,
FIXEZ CELLE-CI À VOTRE PLATE-FORME AVANT D'EFFECTUER L'ÉTAPE #11.**

**IF YOU HAVE BOUGHT ONE OF OUR HEADBOARDS,
ATTACH IT TO YOUR PLATFORM BEFORE DOING STEP #11.**

Étape / Step #11

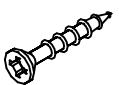

8 x

**VEUILLEZ POSITIONNER VOTRE PLATEFORME DANS
LA PIÈCE AVANT D'INSTALLER LE DESSUS.**

**PLEASE PLACE YOUR PLATFORM IN THE ROOM
BEFORE INSTALLING THE TOP.**

