

22-03-2024

Modèle / Model:

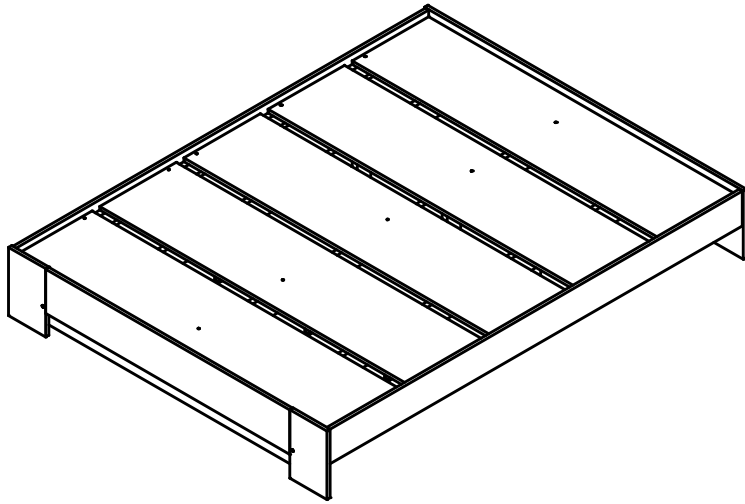

980-39

Plan de montage
Assembling instruction

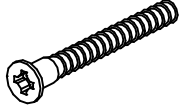
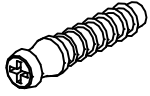
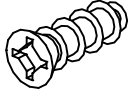
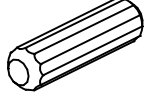

Fabriqué et imprimé au Canada/Made and printed in Canada

1/5

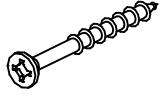
Code	Quincaillerie / Hardware	Qté / Qty
#001	VIS DIRECTA DIRECTA SCREW 	6
#085	DOUILLE DE FACADE FACING DOWEL 	8
#011	VIS À COULISSE SLIDE SCREW 	6
#031	GOUJON DE BOIS WOODEN DOWEL 	6
#090	PATTE À CLOU GLIDE 	13
#904	VIS 1 3/4 - 8 TÊTE PLATE 1 3/4 - 8 FLAT HEAD SCREW 	15

Étape / Step #1

LISTE DES PIÈCES / PART LIST

Boîte 1/3 Box

5 x

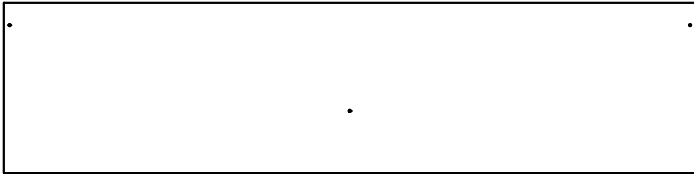

Boîte 3/3 Box

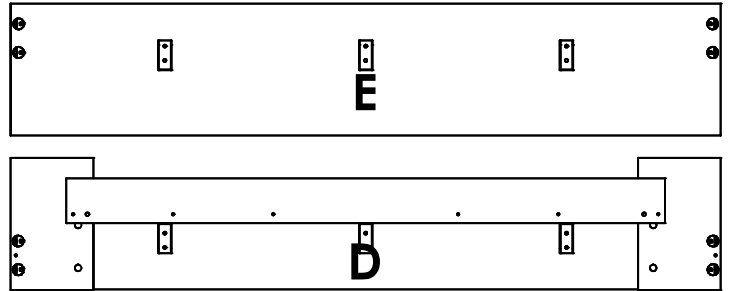

Boîte 2/3 Box

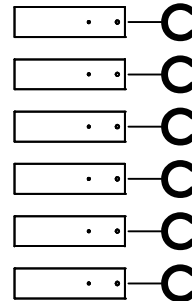
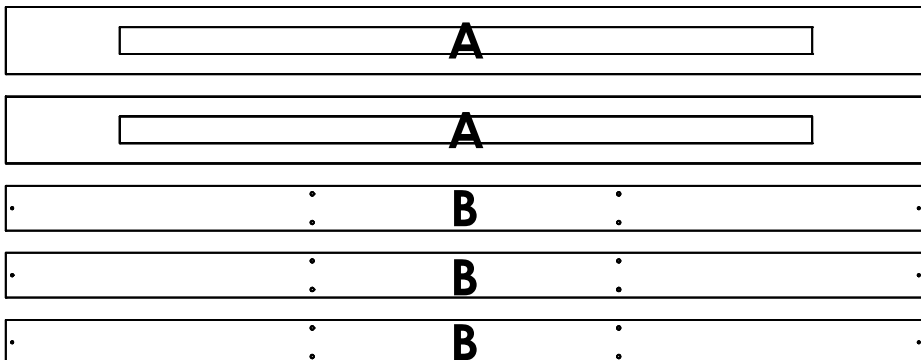

Étape / Step #2

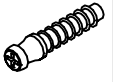

8 x

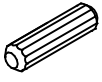

6 x



6 x

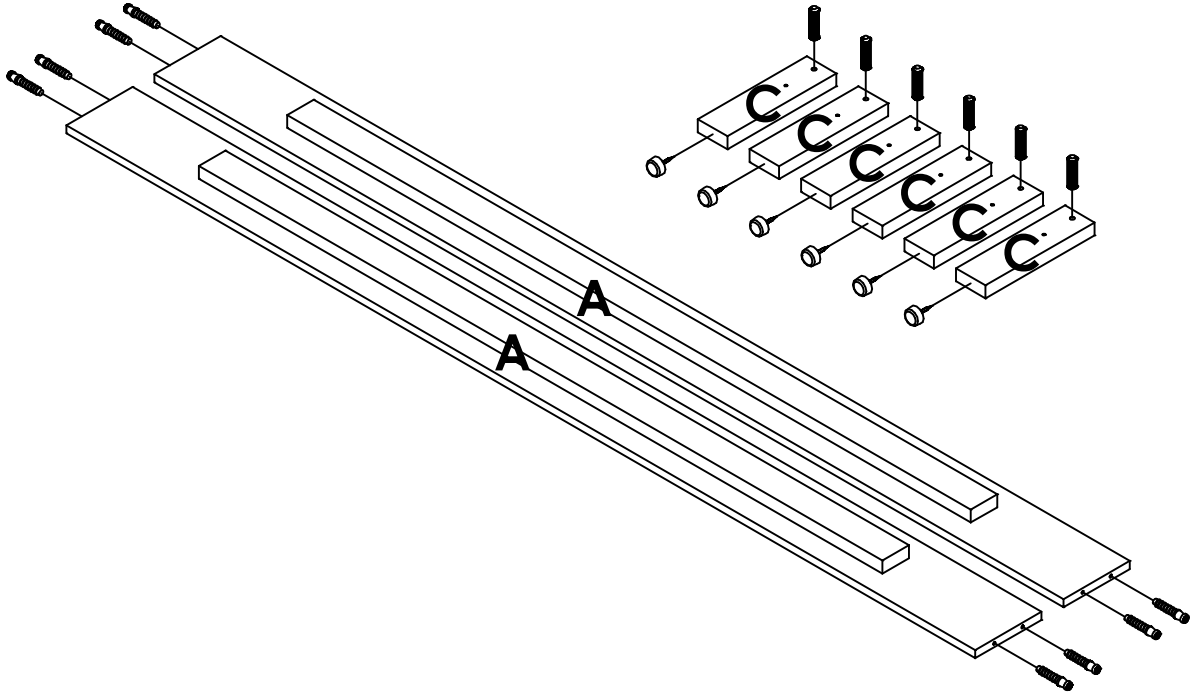

Étape / Step #3



7 x

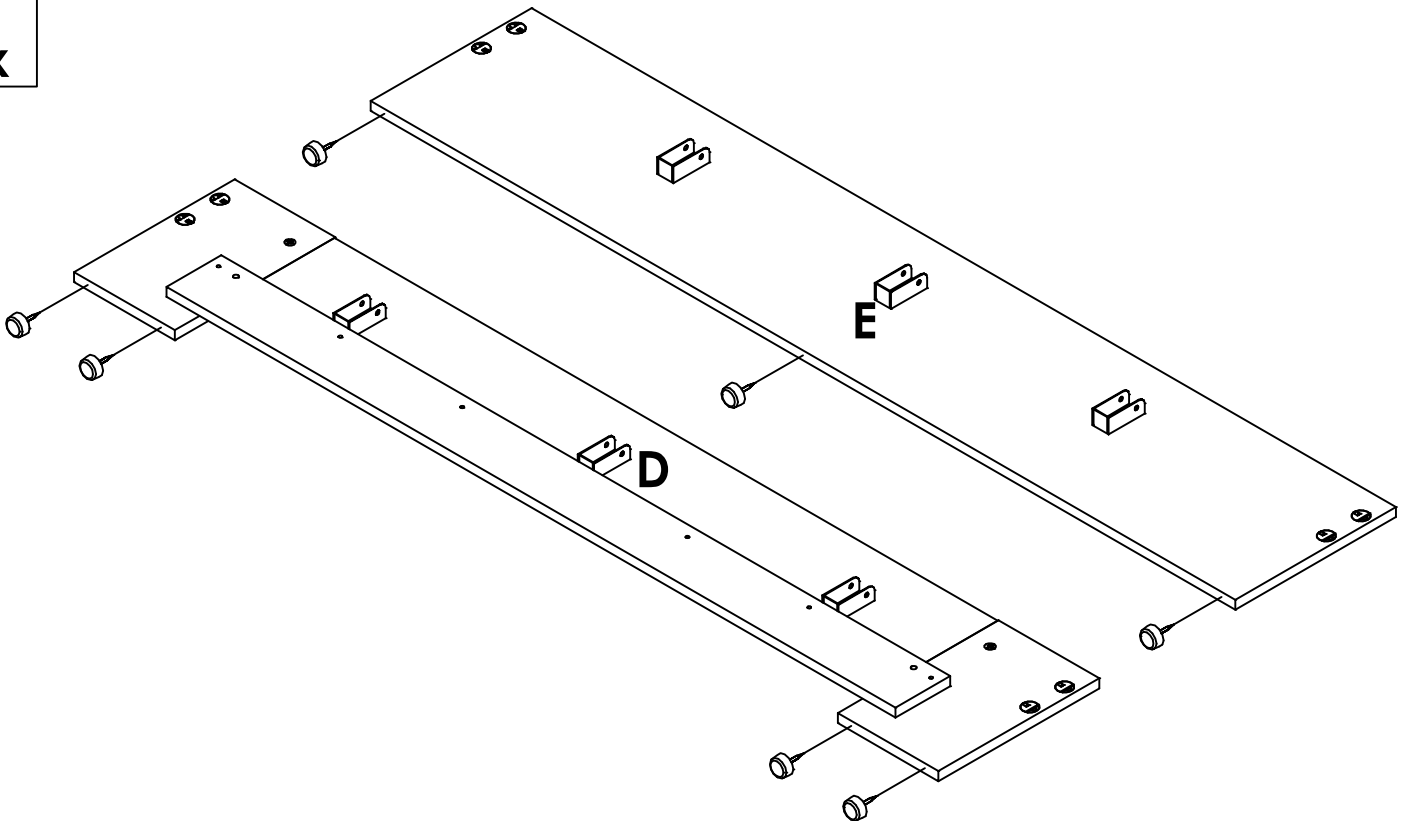

Étape / Step #4



6 x

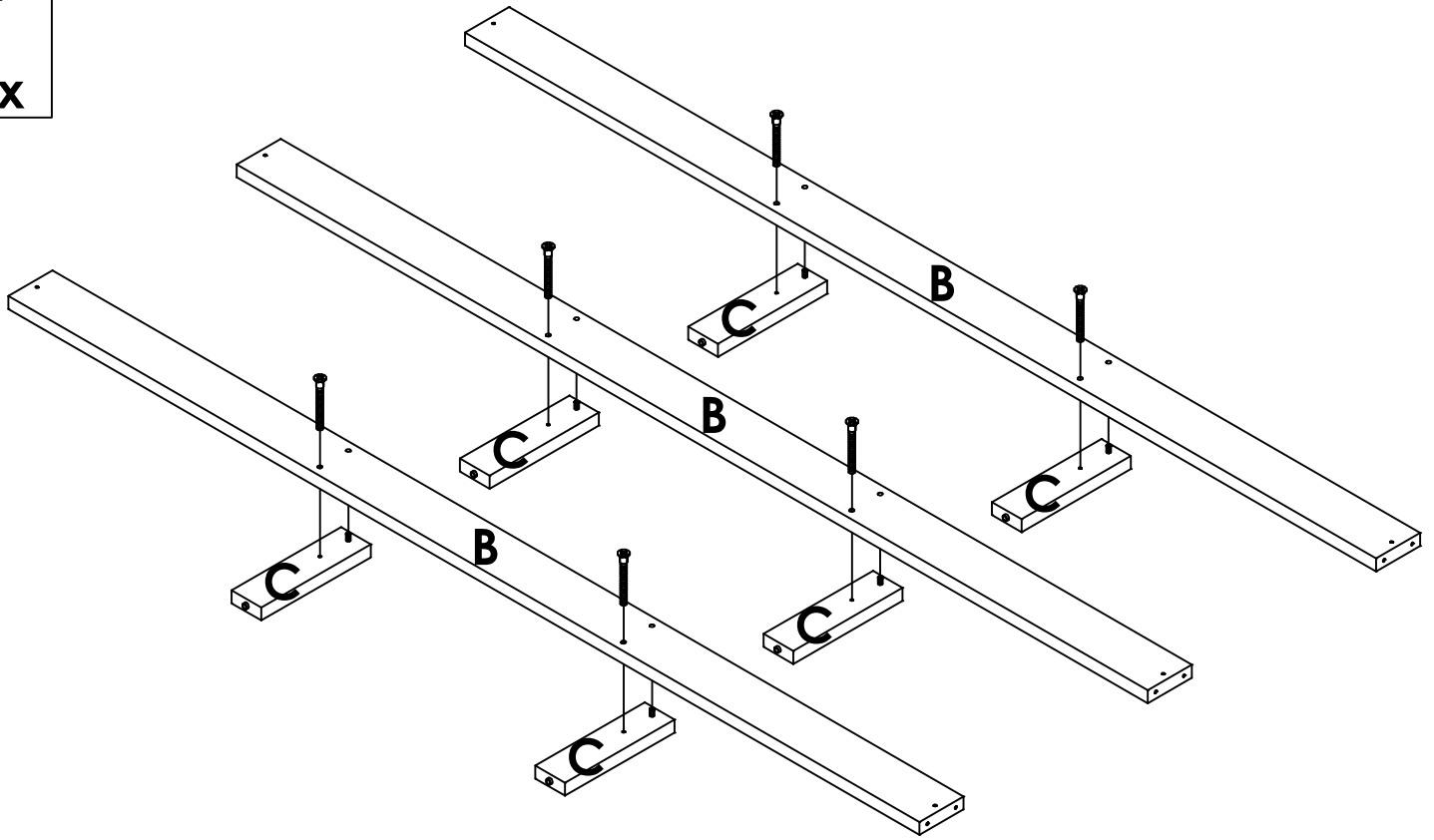

Étape / Step #5

2 x

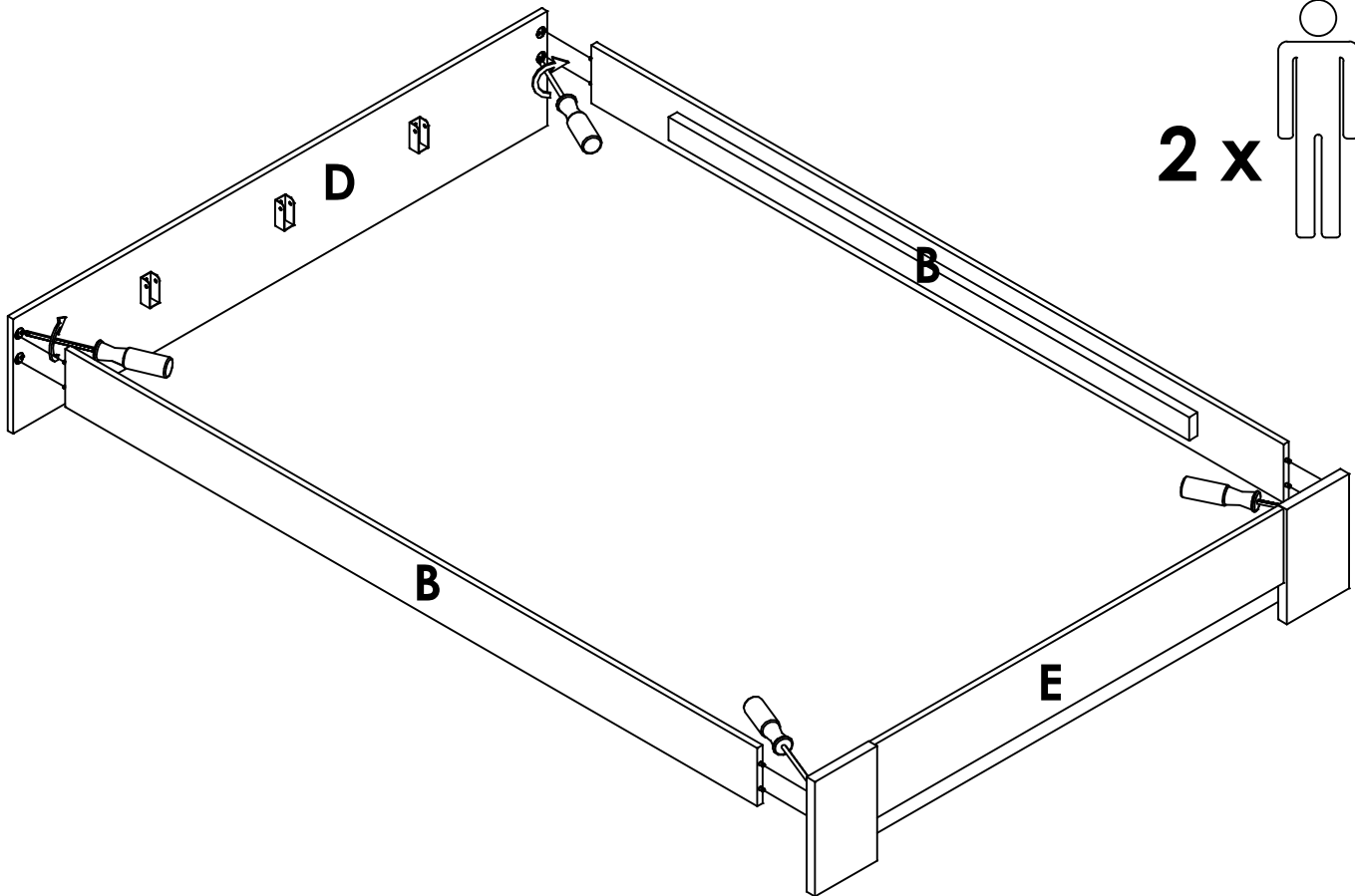
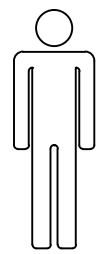

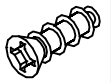
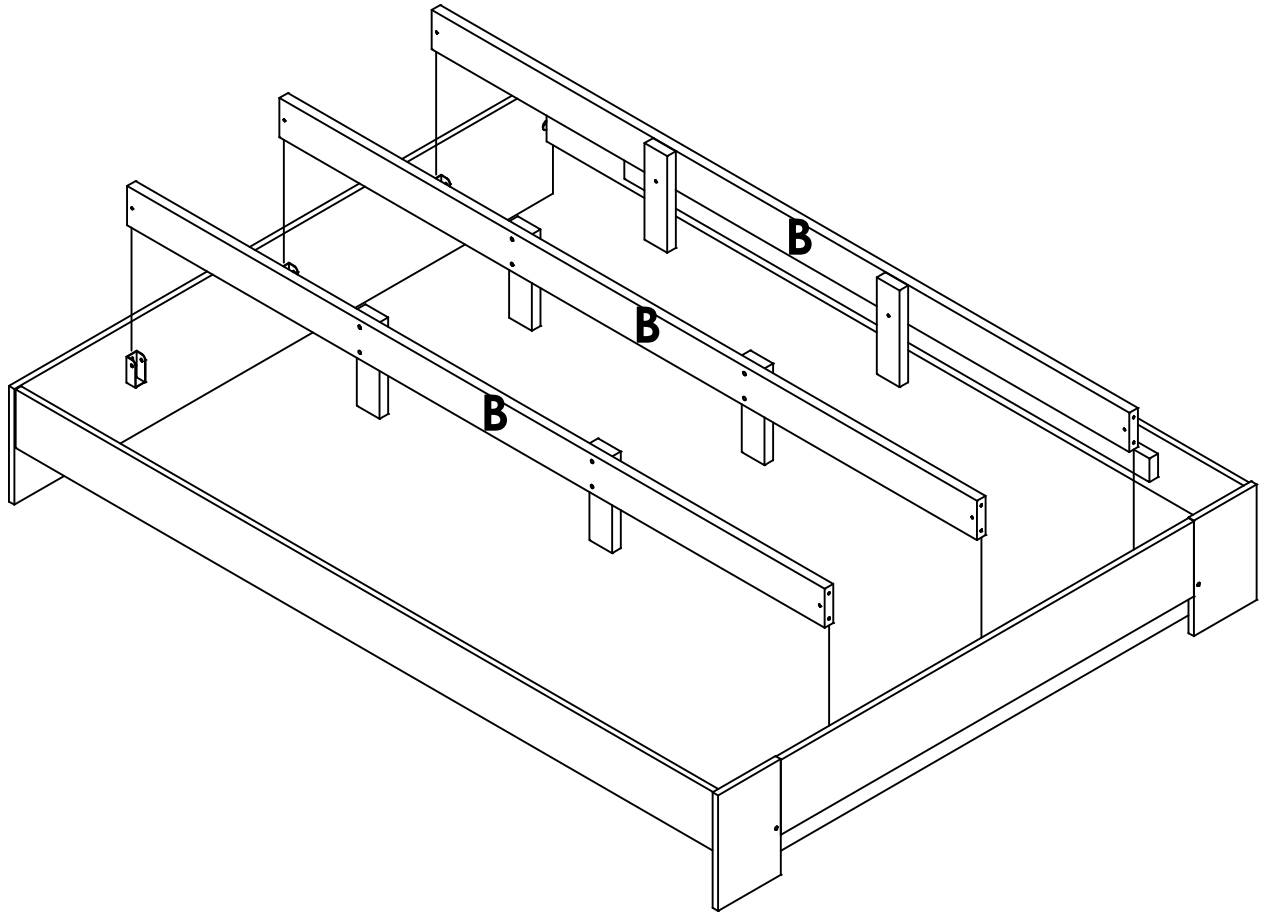

6 x

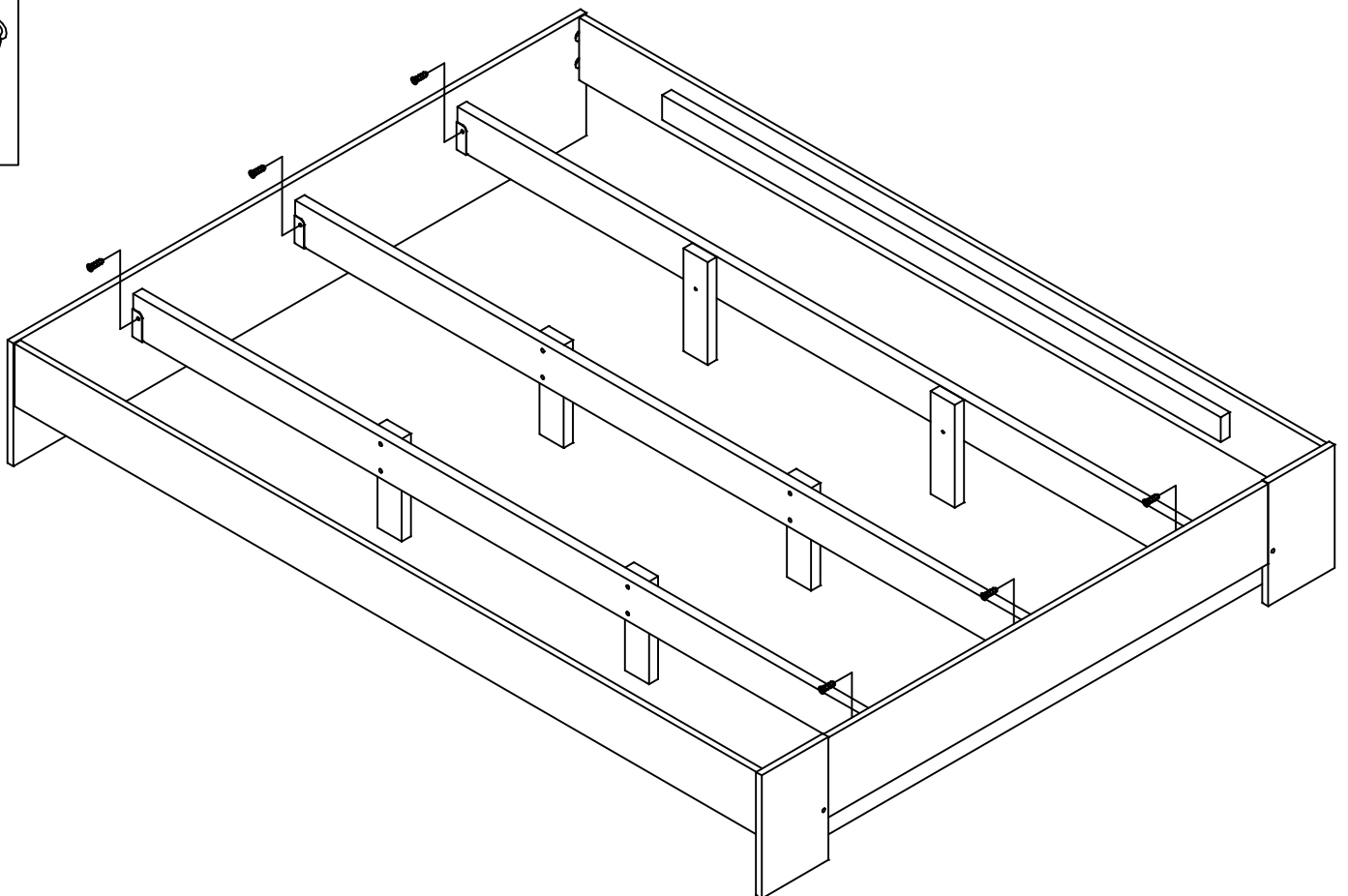



15 x

***Laisser un espace de 1 1/2" (40mm) entre chaque panneau.**

***Leave a space of 1 1/2" (40mm) between each panel.**

