



Kitchenaid® 30-Inch 4-Element Induction Freestanding Commercial-Style Range with Air Fry

KFIS930SJP

Available Finishes/Colours



KFIS930SJP
Juniper



KFIS930SSS
Stainless Steel



KFIS930SBE
Black Ore

This KitchenAid® 4.1 cu. ft. 30-inch 4-Element Induction Slide-In Convection Range combines the precision of induction with the power of Air Fry. Sensor-induction cooktop generates heat directly within cookware, and the oven features Even-Heat™ True Convection plus air fry mode that aids in crisping and browning.

Top Features

Induction Range

Even-Heat™ True Convection

Designed to be Personalized

Manuals & Literature:



[Dimension Guide](#)



[Owners Manual](#)



[Warranty Information](#)

Dimensions		Details	
Depth	28.5	Convection Element Power Watts	1600
Height	36.0	Broiler Location	Top of Oven
Width	29.88	Broiler Element Power	3500W
Details		Bake Element Power	3000W
Convection Element Type	True-Bow Tie	Oven Rack Type	Gliding Roll-Out; Standard
Oven Cleaning Type	Self-Clean	Rack Guide Type	Molded
Number Of Rack Guides	5	Oven Light Type	Halogen
Number Of Oven Racks	2	Oven Light Switch Location	Top of Oven
Number Of Oven Lights	3	Oven Interior Width In Inches	24.0
Interior Color	Black	Oven Interior Depth In Inches	16.3
Hidden Bake Element	Yes		
Cooktop Surface Material	Porcelain Coated Steel		
Convection Functions	No		
Oven Control Knob Color	Juniper		

KITCHENAID® INDUCTION RANGES

PRODUCT: KFIS930S*, KFIS936S*, KFID948S*

MODEL #		30" RANGE		36" RANGE	
		in	cm	in	cm
A	Overall width	28 ⁵ / ₈	72.7	34 ⁵ / ₈	87.9
B	Bull nose Height	2 ¹ / ₄	5.7	2 ¹ / ₄	5.7
C	Control Panel Height	5 ³ / ₈	13.6	5 ³ / ₈	13.6
D	Door Height	20 ¹¹ / ₁₆	52.6	20 ¹¹ / ₁₆	52.6
E	Door Bottom to Handle Top	19 ³ / ₄	50.2	19 ³ / ₄	50.2
F	Toe-Kick Height	5 ¹ / ₂	14	5 ¹ / ₂	14

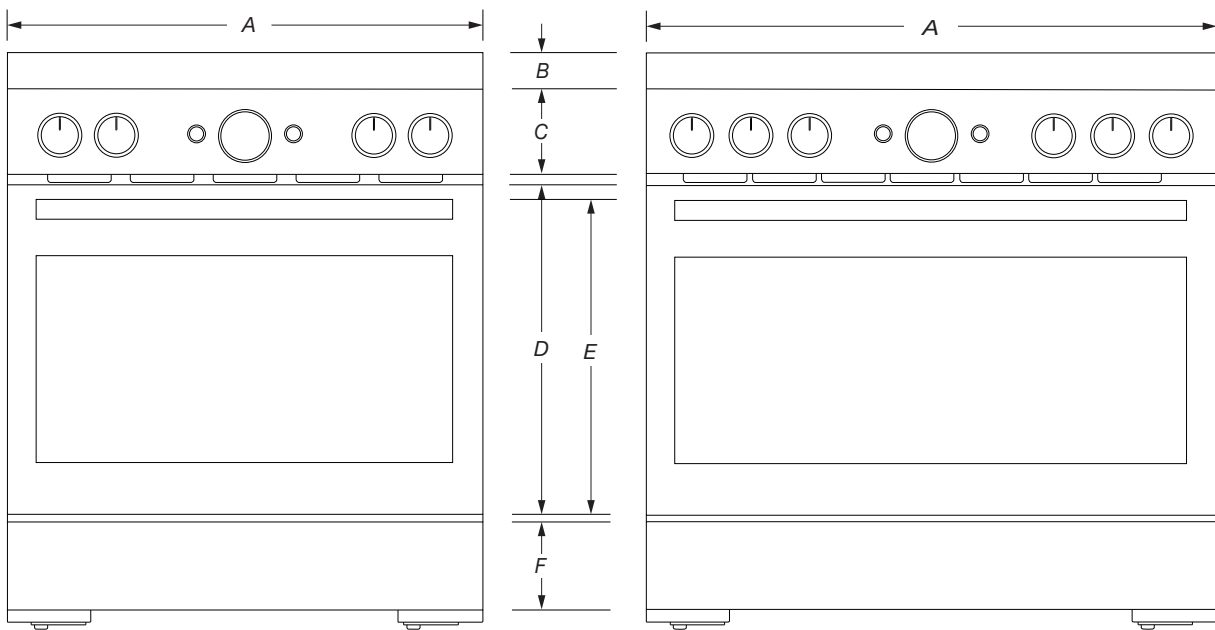

FRONT VIEW

IMPORTANT: Dimensional specifications are provided for planning purposes only.
Do not make any cutouts based on this information. Refer to the Installation Guide before selecting cabinetry, verifying electrical/gas connections, making cutouts or beginning installation.
 All KitchenAid® appliances are appropriately UL, CUL or CSA approved.

KITCHENAID® INDUCTION RANGES

PRODUCT: KFIS930S*, KFIS936S*, KFID948S*

MODEL #		30" RANGE		36" RANGE	
		in	cm	in	cm
G	Depth with Control Panel Overhang	27 ⁹ / ₁₆	70	27 ⁹ / ₁₆	70
H	Depth with Handle	29 ⁹ / ₁₆	75	29 ⁹ / ₁₆	75
I	Depth with Door Fully Open	45 ¹ / ₂	115.5	45 ¹ / ₂	115.5

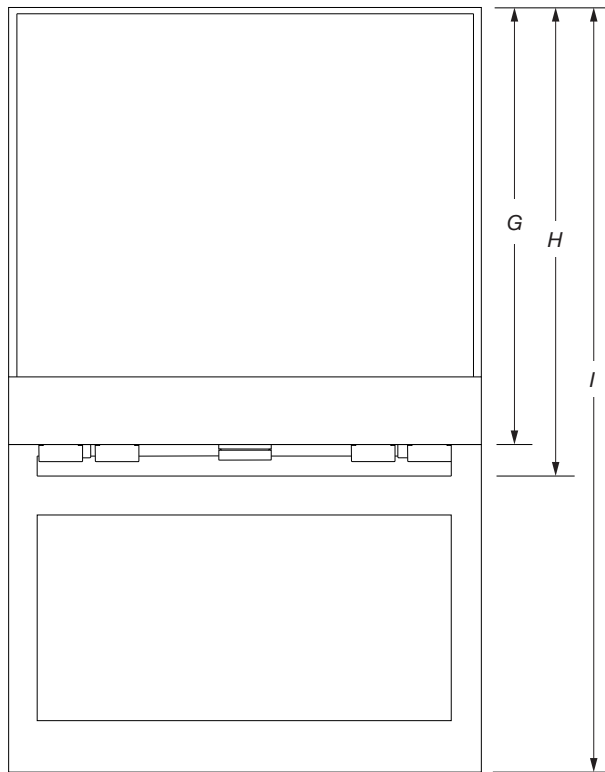

TOP VIEW

KITCHENAID® INDUCTION RANGES

PRODUCT: KFIS930S*, KFIS936S*, KFID948S*

MODEL #		30" RANGE		36" RANGE		48" RANGE	
		in	cm	in	cm	in	cm
A	Cooking Surface Top Height	36 ¹ / ₈	91.8	36 ¹ / ₈	91.8	36 ⁵ / ₁₆	92.2
B	Door Top Height	27 ⁷ / ₈	70.8	27 ¹³ / ₁₆	70.6	27 ¹³ / ₁₆	70.6
C	Handle Top Height	27 ¹ / ₁₆	68.7	27	68.5	27	68.5
D	Toe-Kick Height	6 ³ / ₄	17	6 ³ / ₄	17	6 ³ / ₄	17

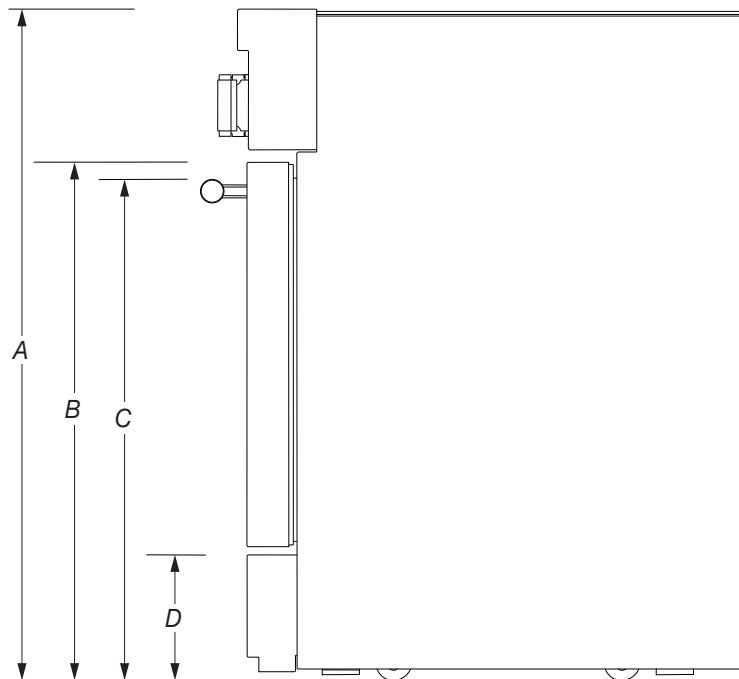

SIDE VIEW

IMPORTANT: Minimum height dimensions are at the lowest point of the height adjustment range. When the leveling legs are fully extended, all heights have 1³/₄" (4.4 cm) of added height.

KITCHENAID® INDUCTION RANGES

PRODUCT: KFIS930S*, KFIS936S*, KFID948S*

MODEL #		30" RANGE		36" RANGE		48" RANGE	
		in	cm	in	cm	in	cm
E	Depth with Door Fully Open	45½	115.5	45½	115.5	45½	115.5
F	Depth with Handle	29 ⁹ / ₁₆	75	29 ⁹ / ₁₆	75	29½	74.9
G	Depth with Control Panel Overhang	27 ⁹ / ₁₆	70	27 ⁹ / ₁₆	70	27 ⁹ / ₁₆	70
H	Depth to Toe-Kick with Door	26 ¹⁵ / ₁₆	68.4	27 ¹ / ₁₆	68.7	27 ¹ / ₁₆	68.7
I	Depth with Door	27 ¹ / ₁₆	68.7	27 ¹ / ₁₆	68.7	27	68.6

MODELS 30" and 36"

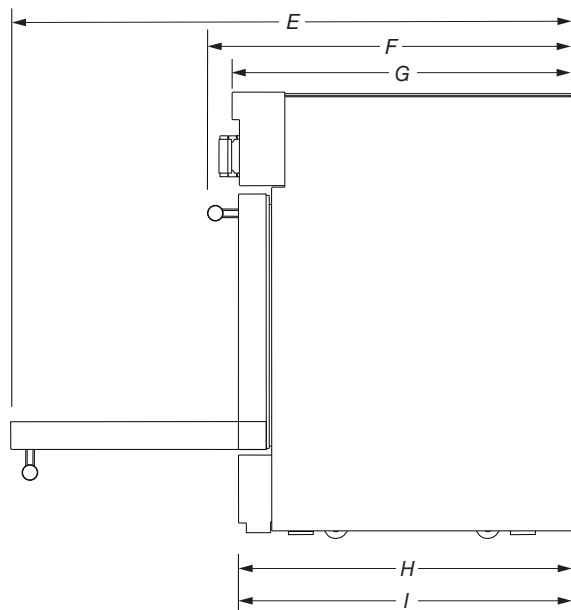

SIDE VIEW

MODEL 48"

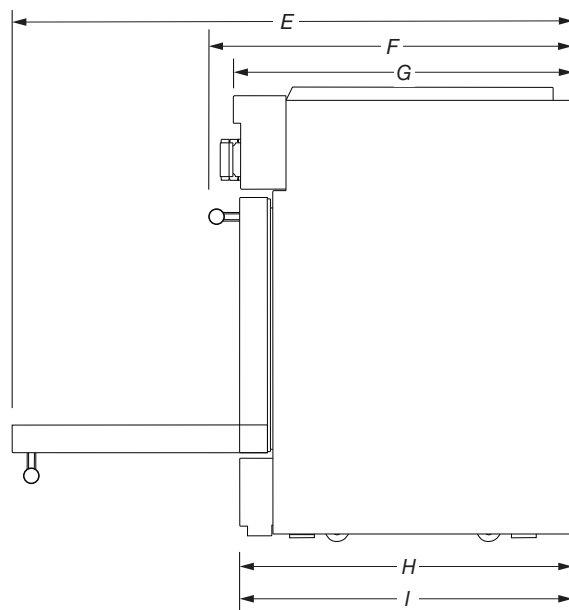

SIDE VIEW

KITCHENAID® INDUCTION RANGES

PRODUCT: KFIS930S*, KFIS936S*, KFID948S*

MODEL #		48" RANGE	
		in	cm
A	Overall width	46¼	117.4
B	Bull nose Height	2¼	5.7
C	Control Panel Height	5¾	13.6
D	Door Height	20 ¹¹ / ₁₆	52.6
E	Door Bottom to Handle Top	19¾	50.2
F	Secondary Oven Door Width	17¾	45
G	Main Oven Door Width	29 ¹¹ / ₁₆	75.3
H	Toe-Kick Height	5½	14

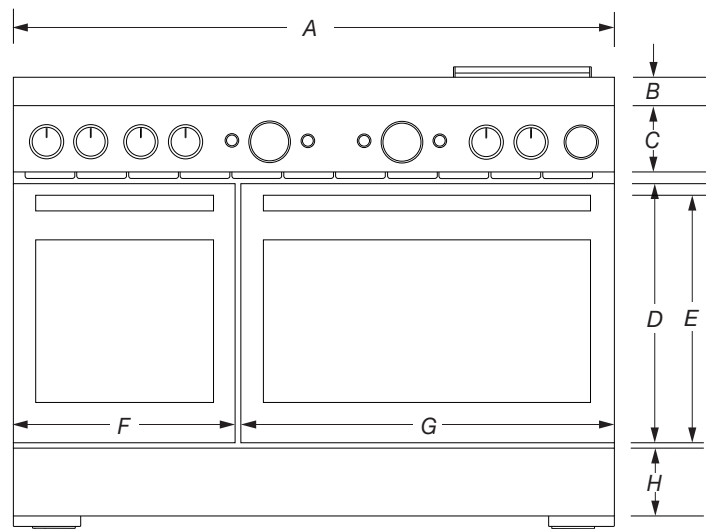

FRONT VIEW

KITCHENAID® INDUCTION RANGES

PRODUCT: KFIS930S*, KFIS936S*, KFID948S*

MODEL #		48" RANGE	
		in	cm
I	Depth with Control Panel Overhang	27 ⁹ / ₁₆	70
J	Depth with Handles	29 ⁹ / ₁₆	75
K	Depth with Doors Fully Open	45 ¹ / ₂	115.5

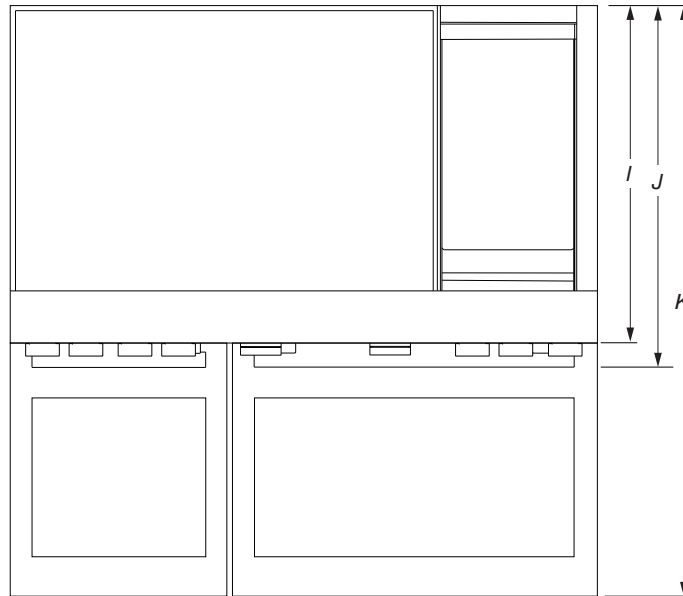

TOP VIEW

KITCHENAID® INDUCTION RANGES
 OPENING AND CLEARANCE

MODEL #		30" RANGE		36" RANGE		48" RANGE	
		in (minimum)	cm (minimum)	in (minimum)	cm (minimum)	in (minimum)	cm (minimum)
A*	Bottom of Cabinet Height Above Cooking Surface	30	76.2	30	76.2	30	76.2
B	Combustible Area Above Cooking Surface Width	30	76.2	36	91.4	48	121.9
C	Upper Cabinet Depth (maximum)	13	33	13	33	13	33
D	Opening Width	30	76.2	36	91.4	48	121.9

*If installing a hood or hood liner above the range, follow the hood or hood liner instructions for dimensional clearances above the cooking surface.

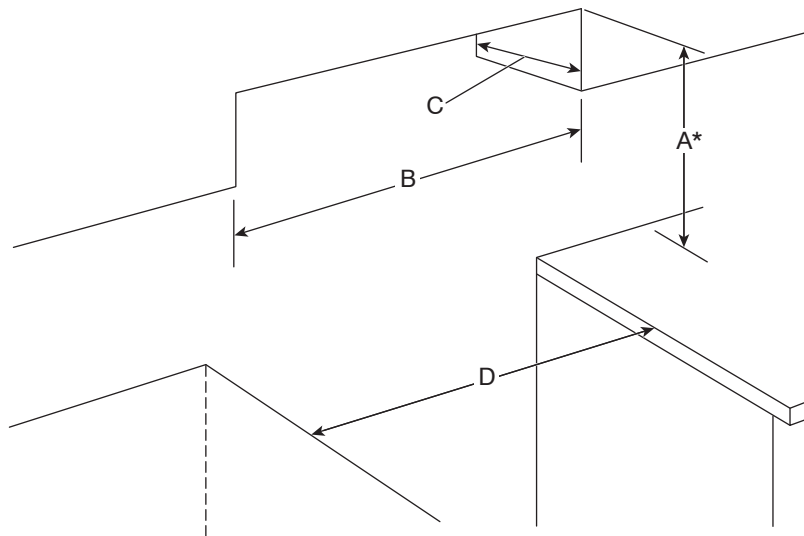

KITCHENAID® INDUCTION RANGES
 OPENING AND CLEARANCE

MODEL #		30" RANGE		36" RANGE		48" RANGE	
		in	cm	in	cm	in	cm
C	Upper Cabinet Depth (maximum)	13	33	13	33	13	33

MODELS 30" and 36"

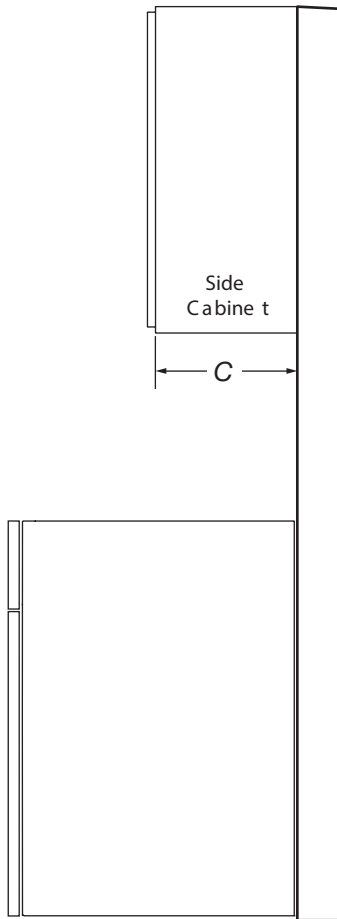

SIDE VIEW

MODEL 48"

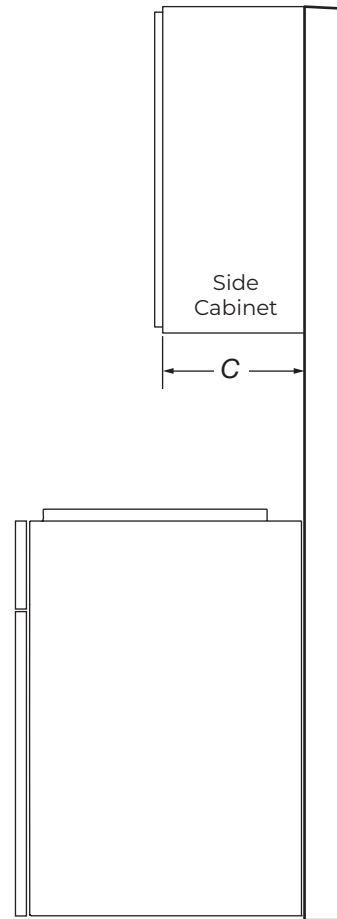

SIDE VIEW

CUISINIÈRES À INDUCTION KITCHENAID®

PRODUITS : KFIS930S*, KFIS936S*, KFID948S*

No de modèle		CUISINIÈRE DE 30 po		CUISINIÈRE DE 36 po	
		po	cm	po	cm
A	Largeur totale	28 ⁵ / ₈	72,7	34 ⁵ / ₈	87,9
B	Hauteur du bord arrondi	2 ¹ / ₄	5,7	2 ¹ / ₄	5,7
C	Hauteur du panneau de commande	5 ³ / ₈	13,6	5 ³ / ₈	13,6
D	Hauteur de la porte	20 ¹¹ / ₁₆	52,6	20 ¹¹ / ₁₆	52,6
E	Bas de la porte au haut de la poignée	19 ³ / ₄	50,2	19 ³ / ₄	50,2
F	Hauteur de la plinthe	5 ¹ / ₂	14	5 ¹ / ₂	14

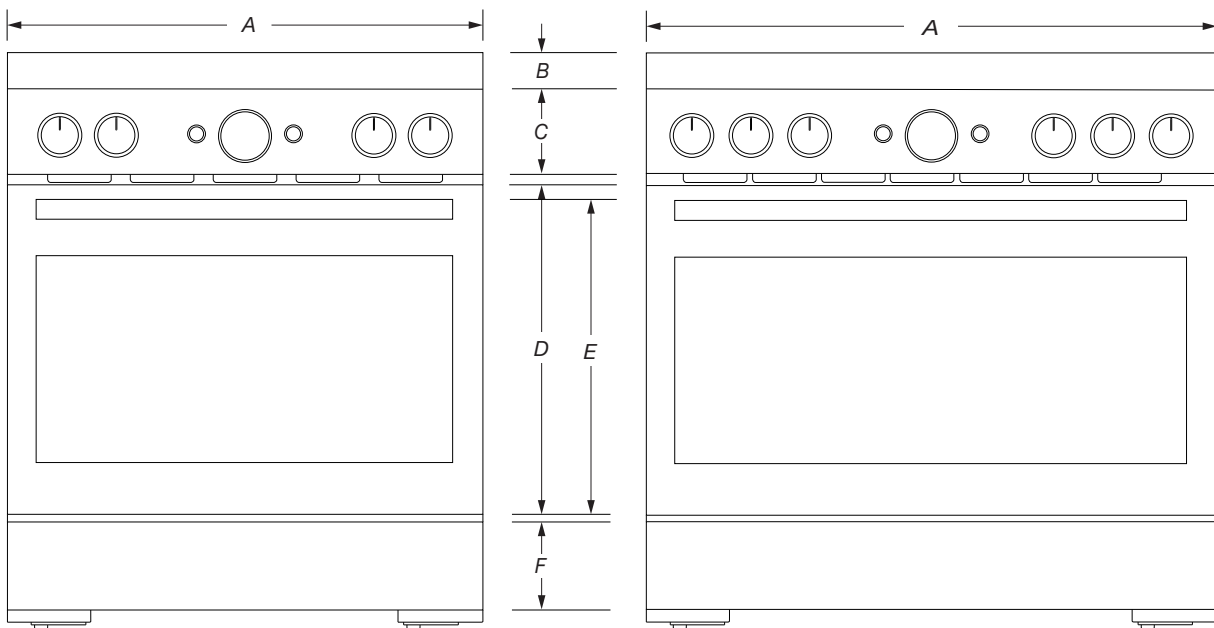

VUE DE FACE

IMPORTANT : Les spécifications dimensionnelles sont fournies uniquement à des fins de planification.

N'aménager aucune ouverture sur la base de cette information. Se référer au guide d'installation avant de choisir une armoire, de vérifier les connexions électriques/gaz, d'effectuer des découpes ou de commencer l'installation.

Tous les appareils KitchenAid® sont homologués UL, CUL ou CSA.

CUISINIÈRES À INDUCTION KITCHENAID®

PRODUITS : KFIS930S*, KFIS936S*, KFID948S*

No de modèle		CUISINIÈRE DE 30 po		CUISINIÈRE DE 36 po	
		po	cm	po	cm
G	Profondeur avec tableau de commande qui dépasse	27 ⁹ / ₁₆	70	27 ⁹ / ₁₆	70
H	Profondeur avec poignée	29 ⁹ / ₁₆	75	29 ⁹ / ₁₆	75
I	Profondeur avec porte complètement ouverte	45 ¹ / ₂	115,5	45 ¹ / ₂	115,5

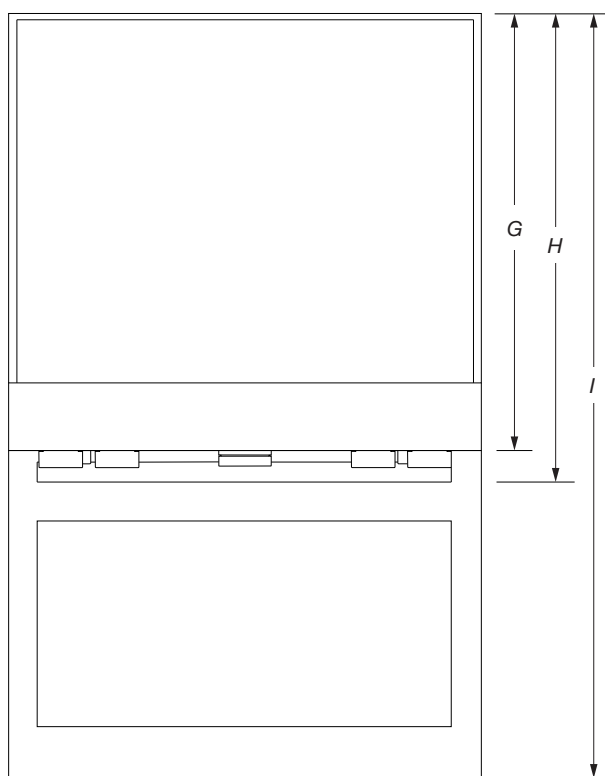

VUE DU DESSUS

CUISINIÈRES À INDUCTION KITCHENAID®
 PRODUITS : KFIS930S*, KFIS936S*, KFID948S*

No de modèle		CUISINIÈRE DE 30 po		CUISINIÈRE DE 36 po		CUISINIÈRE DE 48 po	
		po	cm	po	cm	po	cm
A	Hauteur du dessus de la surface de cuisson	36 ¹ / ₈	91,8	36 ¹ / ₈	91,8	36 ⁵ / ₁₆	92,2
B	Hauteur du dessus de la porte	27 ⁷ / ₈	70,8	27 ¹³ / ₁₆	70,6	27 ¹³ / ₁₆	70,6
C	Hauteur du dessus de la poignée	27 ¹ / ₁₆	68,7	27	68,5	27	68,5
D	Hauteur de la plinthe	6 ³ / ₄	17	6 ³ / ₄	17	6 ³ / ₄	17

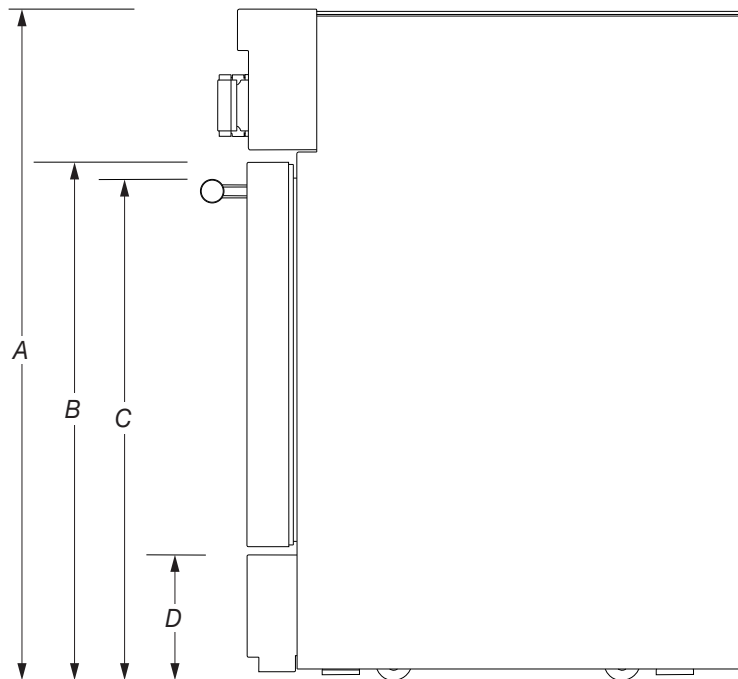

VUE LATÉRALE

IMPORTANT : Les dimensions de hauteur minimum sont indiquées au point le plus bas de l'ajustement de hauteur de la cuisinière.

Lorsque les pieds de nivellement sont à leur extension maximum, toutes les hauteurs sont augmentées de 1 ³/₄ po (4,4 cm).

CUISINIÈRES À INDUCTION KITCHENAID®
 PRODUITS : KFIS930S*, KFIS936S*, KFID948S*

No de modèle		CUISINIÈRE DE 30 po		CUISINIÈRE DE 36 po		CUISINIÈRE DE 48 po	
		po	cm	po	cm	po	cm
E	Profondeur avec porte complètement ouverte	45 1/2	115,5	45 1/2	115,5	45 1/2	115,5
F	Profondeur avec poignée	29 9/16	75	29 9/16	75	29 1/2	74,9
G	Profondeur avec tableau de commande qui dépasse	27 9/16	70	27 9/16	70	27 9/16	70
H	Profondeur à la plinthe avec la porte	26 15/16	68,4	27 1/16	68,7	27 1/16	68,7
I	Profondeur avec porte	27 1/16	68,7	27 1/16	68,7	27	68,6

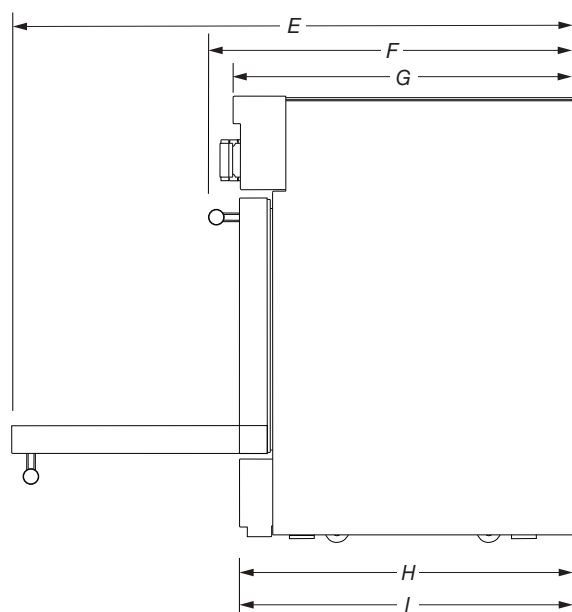
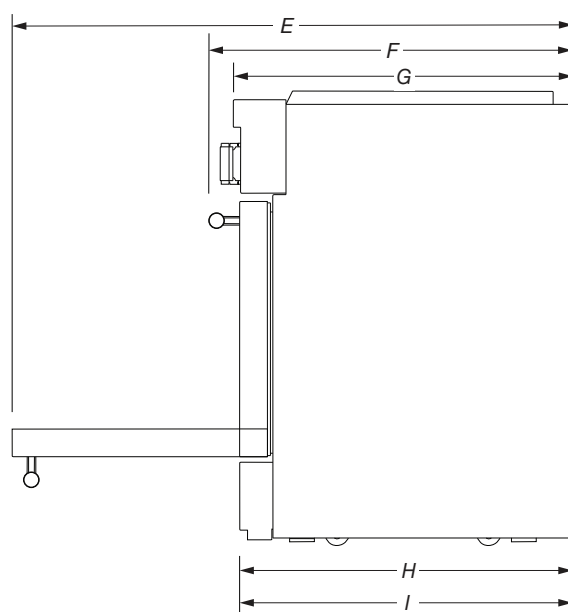
MODÈLES DE 30 po et 36 po

VUE LATÉRALE
MODÈLE DE 48 po

VUE LATÉRALE

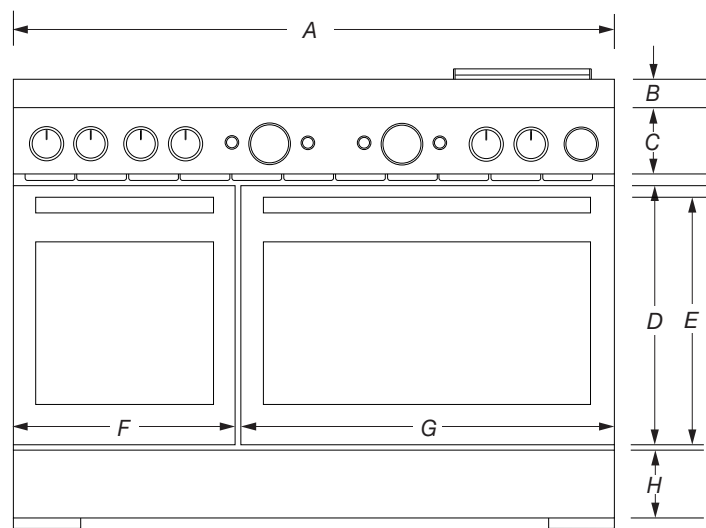
CUISINIÈRES À INDUCTION KITCHENAID® PRODUITS : KFIS930S*, KFIS936S*, KFID948S*

No de modèle		CUISINIÈRE DE 48 po	
		po	cm
A	Largeur totale	46 1/4	117,4
B	Hauteur du bord arrondi	2 1/4	5,7
C	Hauteur du panneau de commande	5 3/8	13,6
D	Hauteur de la porte	20 11/16	52,6
E	Bas de la porte au haut de la poignée	19 3/4	50,2
F	Largeur de la porte secondaire du four	17 3/4	45
G	Largeur de la porte principale du four	29 11/16	75,3
H	Hauteur de la plinthe	5 1/2	14



VUE DE FACE

CUISINIÈRES À INDUCTION KITCHENAID®
 PRODUITS : KFIS930S*, KFIS936S*, KFID948S*

No de modèle		CUISINIÈRE DE 48 po	
		po	cm
I	Profondeur avec tableau de commande qui dépasse	27 ⁹ / ₁₆	70
J	Profondeur avec poignées	29 ⁹ / ₁₆	75
K	Profondeur avec portes complètement ouvertes	45 ¹ / ₂	115,5

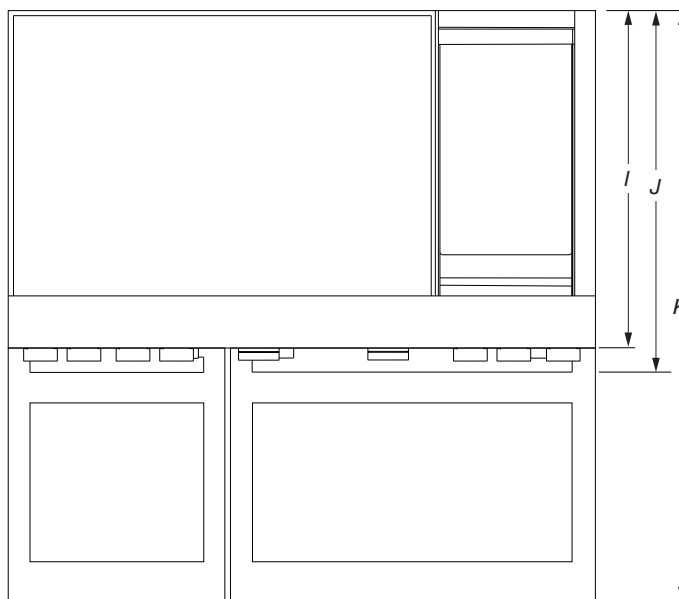

VUE DU DESSUS

CUISINIÈRES À INDUCTION KITCHENAID®
OUVERTURE ET DÉGAGEMENT

No de modèle		CUISINIÈRE DE 30 po		CUISINIÈRE DE 36 po		CUISINIÈRE DE 48 po	
		po (minimum)	cm (minimum)	po (minimum)	cm (minimum)	po (minimum)	cm (minimum)
A*	Bas de la hauteur de l'armoire au-dessus de la surface de cuisson	30	76,2	30	76,2	30	76,2
B	Zone de combustion au-dessus de la largeur de la surface de cuisson	30	76,2	36	91,4	48	121,9
C	Profondeur de l'armoire du dessus (maximum)	13	33	13	33	13	33
D	Largeur de l'ouverture	30	76,2	36	91,4	48	121,9

*Si une hotte ou une caisse de hotte est installée au-dessus de la cuisinière, suivre les instructions de la hotte ou de la caisse de hotte pour connaître les dimensions de dégagement nécessaire au-dessus de la surface de cuisson.

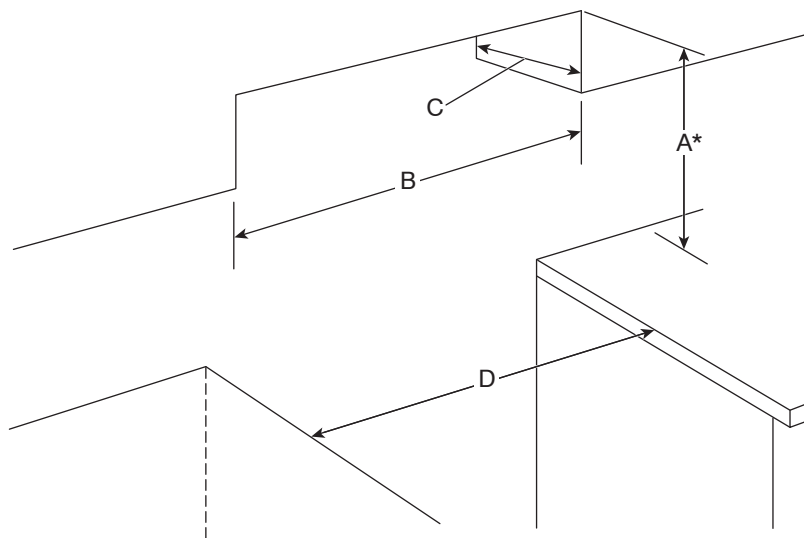

OUVERTURE ET DÉGAGEMENT DES CUISINIÈRES À INDUCTION KITCHENAID®

No de modèle		CUISINIÈRE DE 30 po		CUISINIÈRE DE 36 po		CUISINIÈRE DE 48 po	
		po	cm	po	cm	po	cm
C	Profondeur de l'armoire du dessus (maximum)	13	33	13	33	13	33

MODÈLES DE 30 po et 36 po

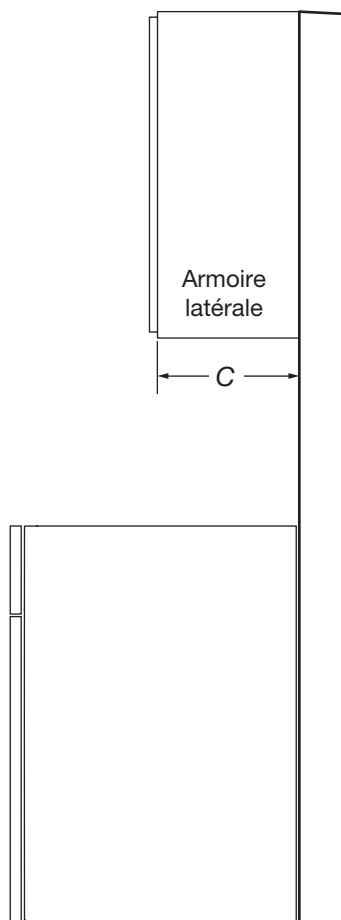

VUE LATÉRALE

MODÈLE DE 48 po

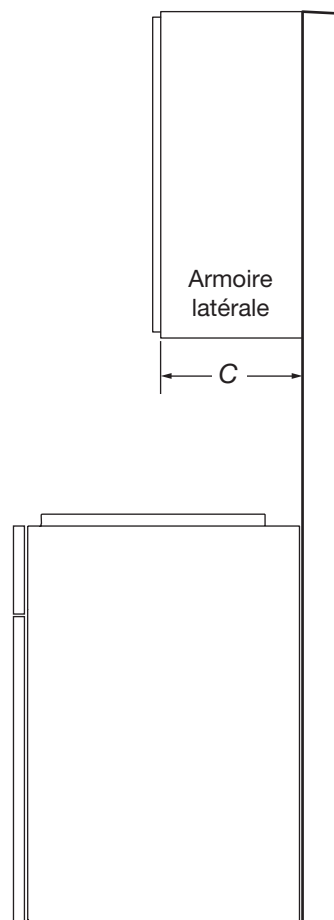

VUE LATÉRALE

ESTUFAS DE INDUCCIÓN KITCHENAID®

PRODUCTO: KFIS930S*, KFIS936S*, KFID948S*

N.º DE MODELO		ESTUFA de 30"		ESTUFA de 36"	
		pulg.	cm	pulg.	cm
A	Ancho total	28 ⁵ / ₈	72,7	34 ⁵ / ₈	87,9
B	Altura de punta ancha	2 ¹ / ₄	5,7	2 ¹ / ₄	5,7
C	Altura del panel de control	5 ³ / ₈	13,6	5 ³ / ₈	13,6
D	Altura de la puerta	20 ¹¹ / ₁₆	52,6	20 ¹¹ / ₁₆	52,6
E	Base de puerta a parte superior de jaladera	19 ³ / ₄	50,2	19 ³ / ₄	50,2
F	Altura de cubierta protectora	5 ¹ / ₂	14	5 ¹ / ₂	14

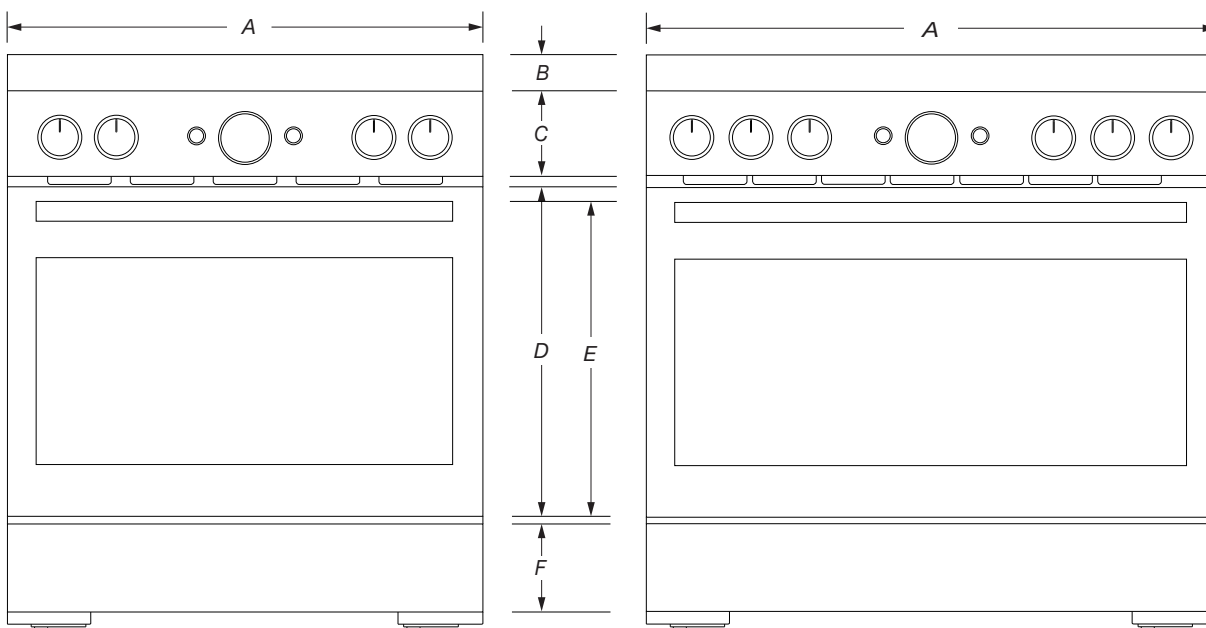

VISTA FRONTAL

IMPORTANTE: Las especificaciones de medidas son solo para fines de planificación.

No realice ningún corte basado en esta información. Consulte la Guía de instalación antes de seleccionar los gabinetes, verificar las conexiones eléctricas/de gas, realizar cortes o iniciar la instalación.

Todos los electrodomésticos KitchenAid® poseen la homologación UL, CUL o CSA pertinente.

ESTUFAS DE INDUCCIÓN KITCHENAID®

PRODUCTO: KFIS930S*, KFIS936S*, KFID948S*

N.º DE MODELO		ESTUFA de 30"		ESTUFA de 36"	
		pulg.	cm	pulg.	cm
G	Profundidad con saliente de panel de control	27 ⁹ / ₁₆	70	27 ⁹ / ₁₆	70
H	Profundidad con manijas	29 ⁹ / ₁₆	75	29 ⁹ / ₁₆	75
I	Profundidad con la puerta totalmente abierta	45 ¹ / ₂	115,5	45 ¹ / ₂	115,5

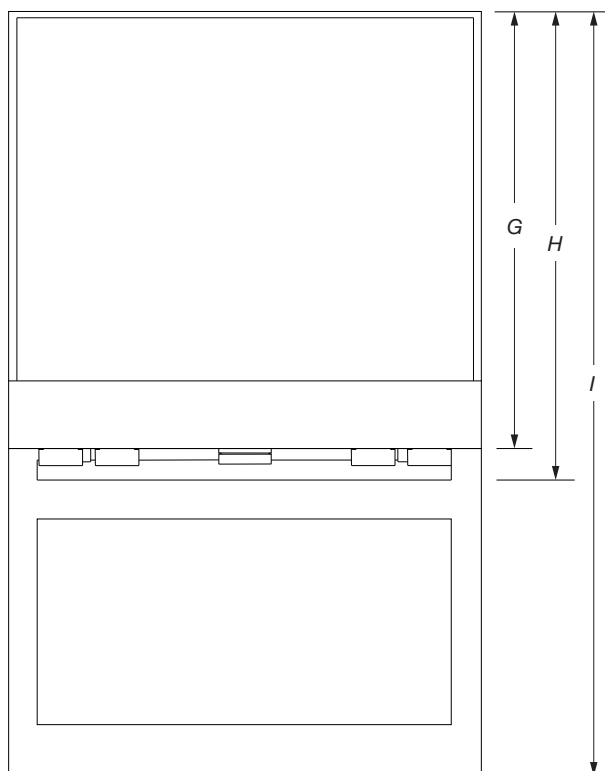

VISTA SUPERIOR

ESTUFAS DE INDUCCIÓN KITCHENAID®

PRODUCTO: KFIS930S*, KFIS936S*, KFID948S*

N.º DE MODELO		ESTUFA de 30"		ESTUFA de 36"		ESTUFA de 48"	
		pulg.	cm	pulg.	cm	pulg.	cm
A	Altura hasta la parte superior de superficie de cocción	36 ¹ / ₈	91,8	36 ¹ / ₈	91,8	36 ⁵ / ₁₆	92,2
B	Altura hasta parte superior de la puerta	27 ⁷ / ₈	70,8	27 ¹³ / ₁₆	70,6	27 ¹³ / ₁₆	70,6
C	Altura hasta parte superior de la manija	27 ¹ / ₁₆	68,7	27	68,5	27	68,5
D	Altura de cubierta protectora	6 ³ / ₄	17	6 ³ / ₄	17	6 ³ / ₄	17

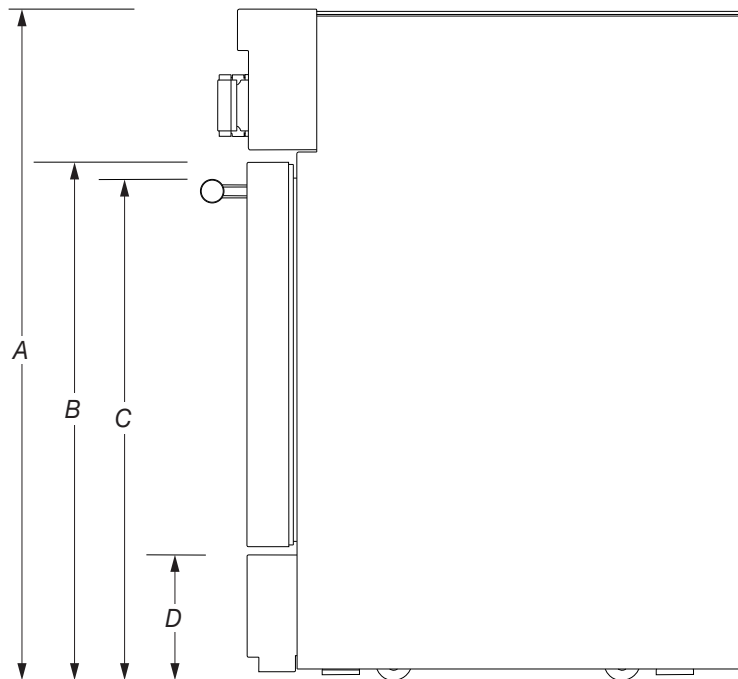

VISTA LATERAL

IMPORTANTE: Las medidas de altura mínima son el valor más bajo del rango de ajuste de altura. Cuando las patas niveladoras se extienden por completo, se debe sumar una altura adicional de 1³/₄" (4,4 cm) a las alturas indicadas.

ESTUFAS DE INDUCCIÓN KITCHENAID®

PRODUCTO: KFIS930S*, KFIS936S*, KFID948S*

N.º DE MODELO		ESTUFA de 30"		ESTUFA de 36"		ESTUFA de 48"	
		pulg.	cm	pulg.	cm	pulg.	cm
E	Profundidad con la puerta totalmente abierta	45½	115,5	45½	115,5	45½	115,5
F	Profundidad con manijas	29 ⁹ / ₁₆	75	29 ⁹ / ₁₆	75	29½	74,9
G	Profundidad con saliente de panel de control	27 ⁹ / ₁₆	70	27 ⁹ / ₁₆	70	27 ⁹ / ₁₆	70
H	Profundidad desde zócalo con puerta	26 ¹⁵ / ₁₆	68,4	27 ¹ / ₁₆	68,7	27 ¹ / ₁₆	68,7
I	Profundidad con puerta	27 ¹ / ₁₆	68,7	27 ¹ / ₁₆	68,7	27	68,6

MODELOS DE 30" y 36"

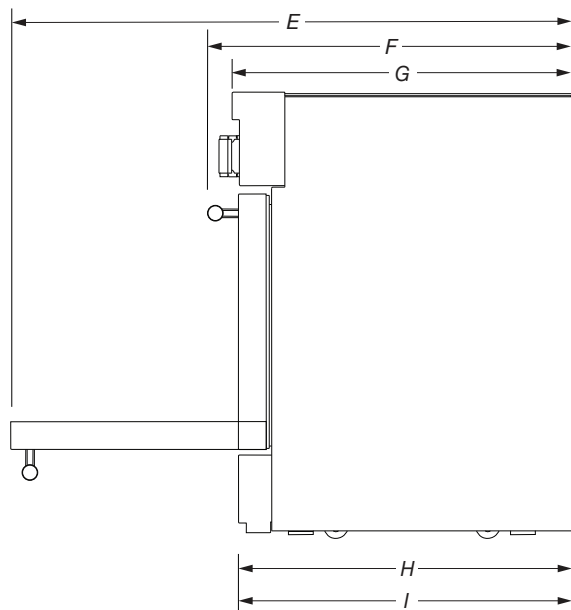

VISTA LATERAL

MODELO DE 48"

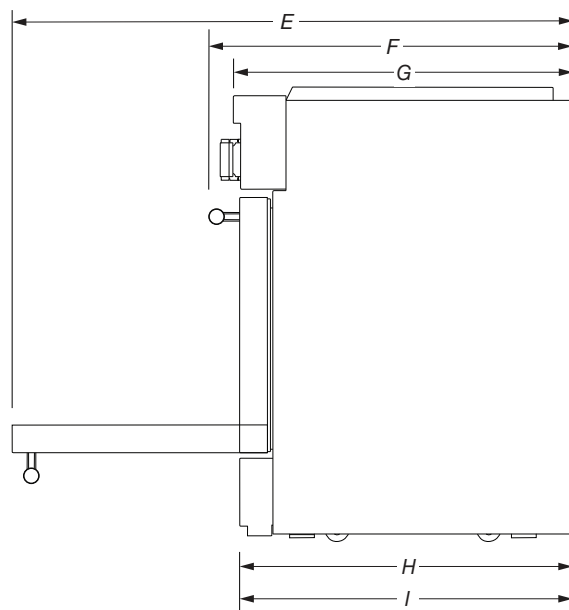

VISTA LATERAL

ESTUFAS DE INDUCCIÓN KITCHENAID®

PRODUCTO: KFIS930S*, KFIS936S*, KFID948S*

N.º DE MODELO		ESTUFA de 48"	
		pulg.	cm
A	Ancho total	46¼	117,4
B	Altura de punta ancha	2¼	5,7
C	Altura del panel de control	5¾	13,6
D	Altura de la puerta	20 ¹¹ / ₁₆	52,6
E	Base de puerta a parte superior de jaladera	19¾	50,2
F	Ancho de puerta de horno secundario	17¾	45
G	Ancho de puerta de horno principal	29 ¹¹ / ₁₆	75,3
H	Altura de cubierta protectora	5½	14

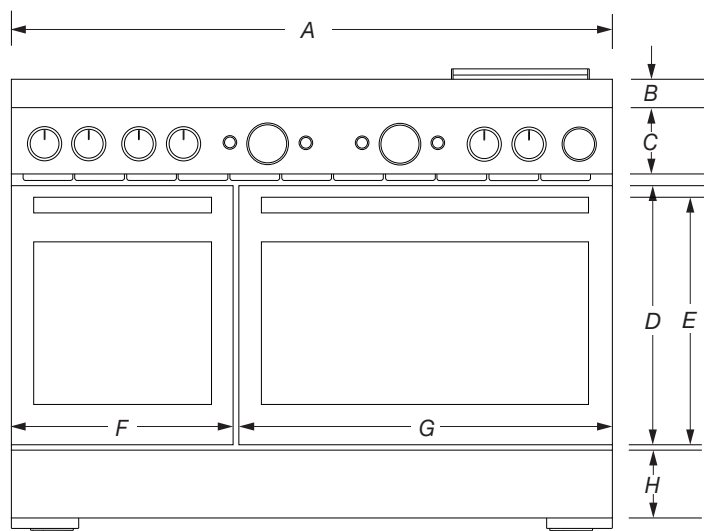

VISTA FRONTAL

ESTUFAS DE INDUCCIÓN KITCHENAID®

PRODUCTO: KFIS930S*, KFIS936S*, KFID948S*

N.º DE MODELO		ESTUFA de 48"	
		pulg.	cm
I	Profundidad con saliente de panel de control	27 ⁹ / ₁₆	70
J	Profundidad con manijas	29 ⁹ / ₁₆	75
K	Profundidad con las puertas totalmente abiertas	45 ¹ / ₂	115,5

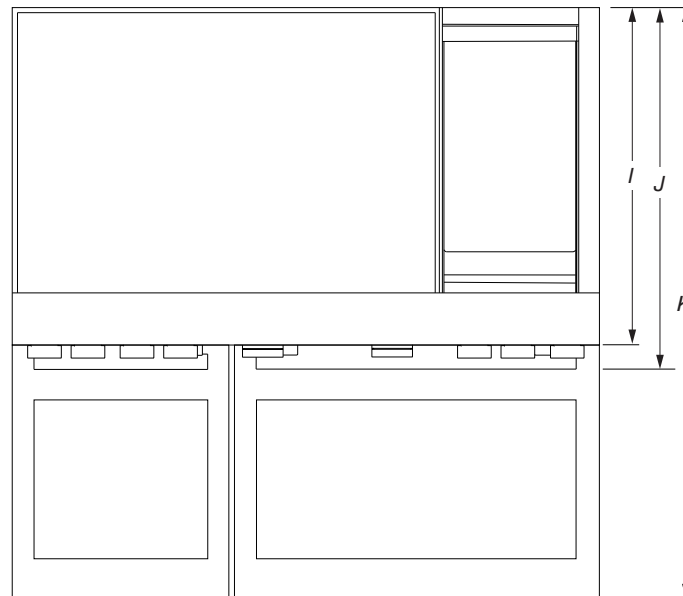

VISTA SUPERIOR

ESTUFAS DE INDUCCIÓN KITCHENAID® ABERTURA Y ESPACIO LIBRE

N.º DE MODELO		ESTUFA de 30"		ESTUFA de 36"		ESTUFA de 48"	
		pulg. (mínimo)	cm (mínimo)	pulg. (mínimo)	cm (mínimo)	pulg. (mínimo)	cm (mínimo)
A*	Altura de la base del gabinete sobre la superficie de cocción	30	76,2	30	76,2	30	76,2
B	Ancho de área de combustión sobre la superficie de cocción	30	76,2	36	91,4	48	121,9
C	Profundidad de gabinete superior (máxima)	13	33	13	33	13	33
D	Ancho de la abertura	30	76,2	36	91,4	48	121,9

*En caso de instalar una campana o un revestimiento de campana sobre la estufa, siga las indicaciones de la campana o el revestimiento de campana para las medidas del espacio sobre la superficie de cocción.

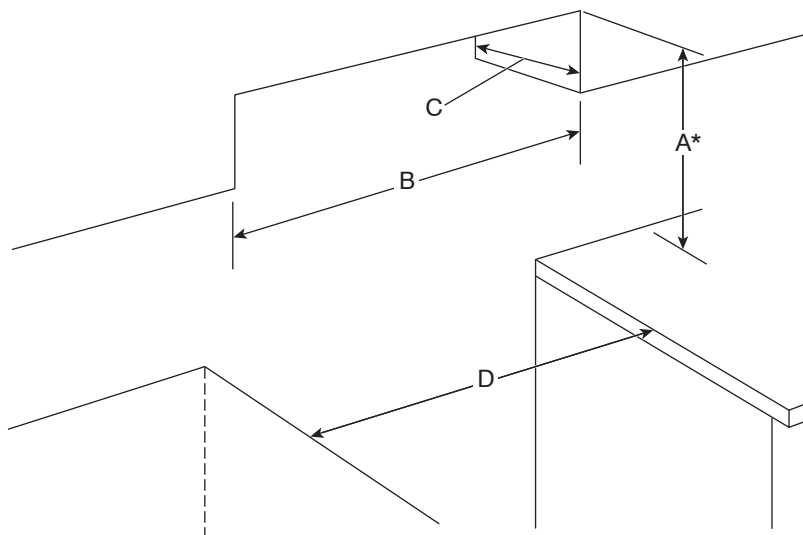

ESTUFAS DE INDUCCIÓN KITCHENAID®
 ABERTURA Y ESPACIO LIBRE

N.º DE MODELO		ESTUFA de 30"		ESTUFA de 36"		ESTUFA de 48"	
		pulg.	cm	pulg.	cm	pulg.	cm
C	Profundidad de gabinete superior (máxima)	13	33	13	33	13	33

MODELOS DE 30" y 36"

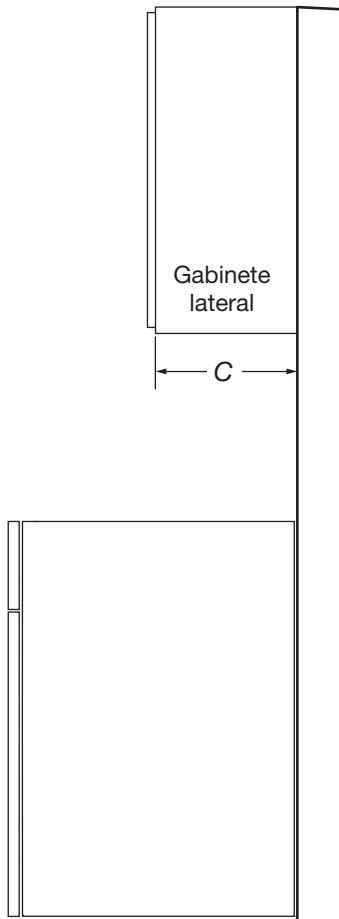

VISTA LATERAL

MODELO DE 48"

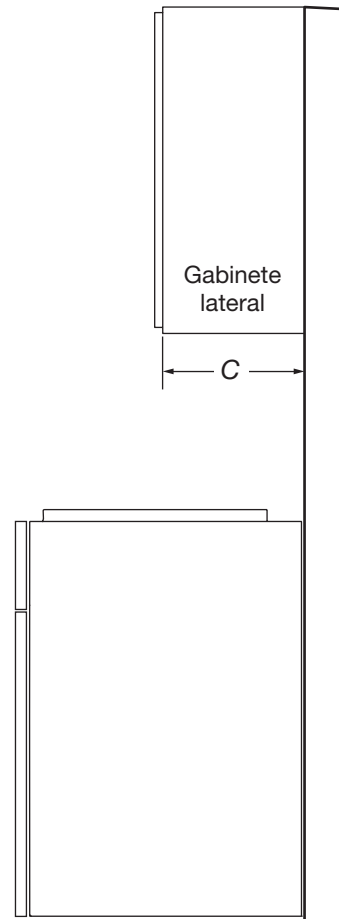

VISTA LATERAL

®/™ ©2025 KitchenAid. All rights reserved.
 The design of the stand mixer is a trademark in the U.S.
 and elsewhere. Used under license in Canada.

Tous droits réservés.
 La forme du batteur sur socle est une marque de
 commerce aux É.-U. et dans d'autres pays. Utilisé sous
 licence au Canada.

Todos los derechos reservados.
 El diseño de la batidora es una marca comercial en EE. UU.
 y en otros países. Usado bajo licencia en Canadá.

