



INSTRUCTIONS D'ASSEMBLAGE
ASSEMBLY INSTRUCTIONS

MONARCH
SPECIALTIES INC.

I 5276

CHAMBRE A COUCHER -
COMMODE 6 TIROIRS / CHENE MOYEN

BEDROOM SET -
6 DRAWER DRESSER / MEDIUM OAK FINISH



POUR DE L'ASSISTANCE OU POUR COMMANDER
DES PIÈCES CONTACTEZ NOTRE DÉPARTEMENT
DE SERVICE À LA CLIENTÈLE.

FOR ASSISTANCE OR TO ORDER PARTS
CONTACT OUR CUSTOMER SERVICE DEPARTMENT

WWW.MONARCHSERVICE.COM

LISTE DES PIÈCES
PARTS LIST

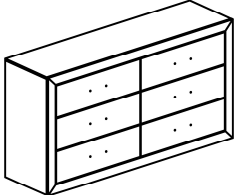
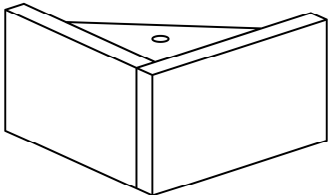
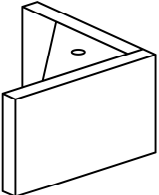
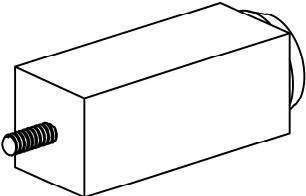
PIÈCE / PART #	IMAGE	DESCRIPTION	QTY / QTÉ
1		<p align="center">TOP DESSUS</p>	1
2		<p align="center">LEG PATTE</p>	2
3		<p align="center">LEG PATTE</p>	2
4		<p align="center">SUPPORT LEG PATTE DE SOUTIEN</p>	1

LISTE DES PIÈCES DE MONTAGE
HARDWARE LIST

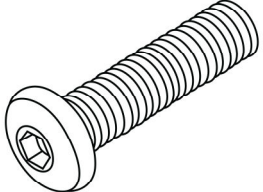
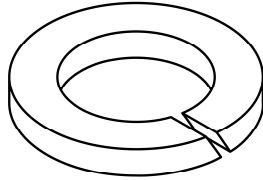
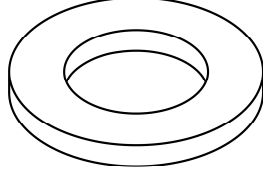
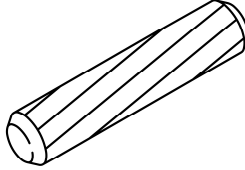
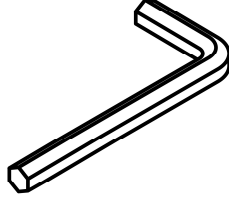
PIÈCE / PART #	IMAGE	DESCRIPTION	QTY / QTÉ
A		ASSEMBLING BOLT - 1/4" X 1 5/8" BOULON D'ASSEMBLAGE - 1/4" X 1 5/8"	4
B		LOCK WASHER - 1/4" X 1/2" ENTRETOISE DE MÉTAL - 1/4" X 1/2"	4
C		METAL WASHER - 1/4" X 3/4" RONDELLE DE MÉTAL - 1/4" X 3/4"	4
D		WOOD DOWEL GOUJON DE BOIS	4
E		HEX KEY CLÉ HEXAGONALE	1

LISTE DES PIÈCES DE MONTAGE
HARDWARE LIST

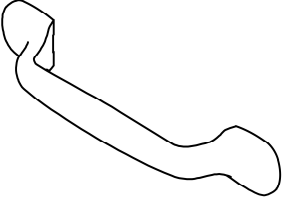
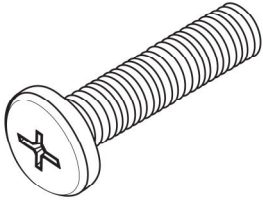
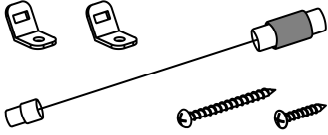
PIÈCE / PART #	IMAGE	DESCRIPTION	QTY / QTÉ
F		<p align="center">HANDLE POIGNÉE</p>	6
G		<p align="center">ASSEMBLING BOLT - 1/8" X 1" BOULON D'ASSEMBLAGE - 1/8" X 1"</p>	12
H		<p align="center">WALL MOUNT SET ENSEMBLE DE MONTAGE MURAL</p>	1



OUTIL DE VÉRIFICATION DE DIMENSIONS DES PIÈCES
HARDWARE DIMENSIONS VERIFICATION TOOL



ÉTAPE / STEP 1

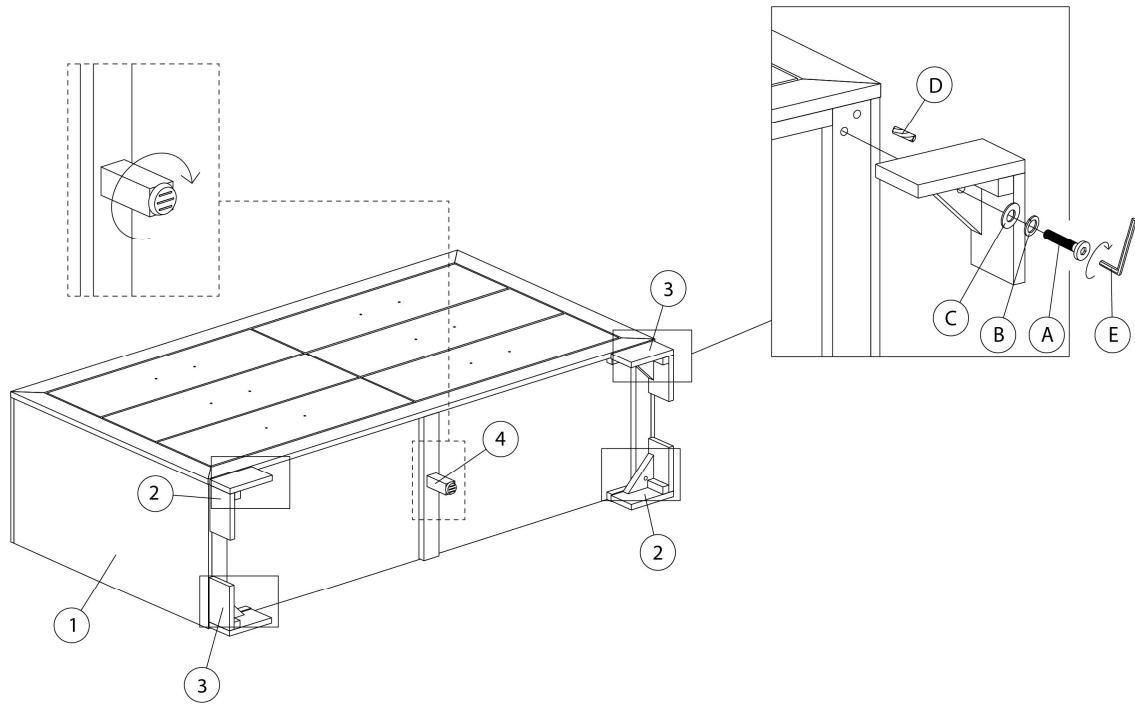

ÉTAPE / STEP 2

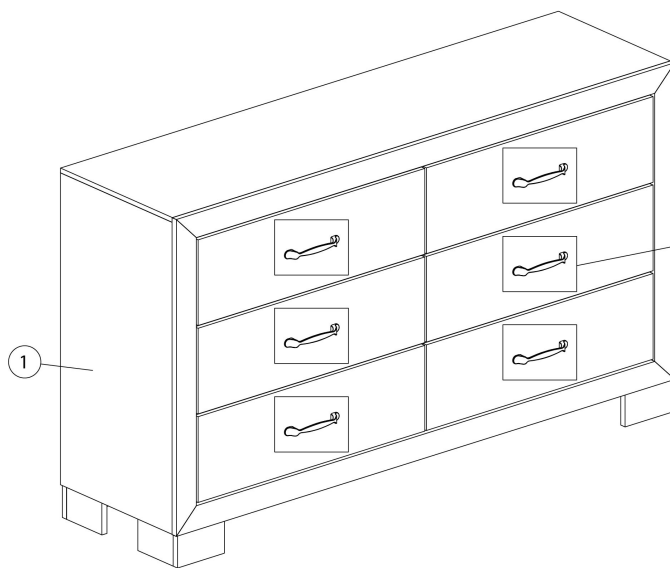

DESSERRER LA VIS ET CHANGER LA
POSITION DE LA POIGNÉE EN AVANT /
LOOSEN THE SCREW AND CHANGE THE
HANDLE POSITION TO FRONT

ÉTAPE / STEP 2.1

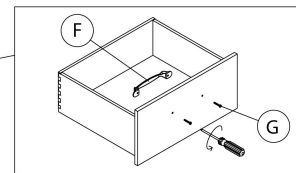

ÉTAPE / STEP 2.2

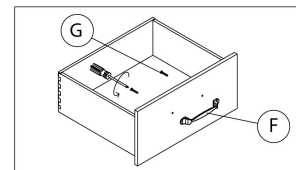

ÉTAPE / STEP 3

PANNEAUX ET MONTANTS
MURAUX /
WALL BOARD AND STUD

DESSUS DE MEUBLES /
FURNITURE TOP

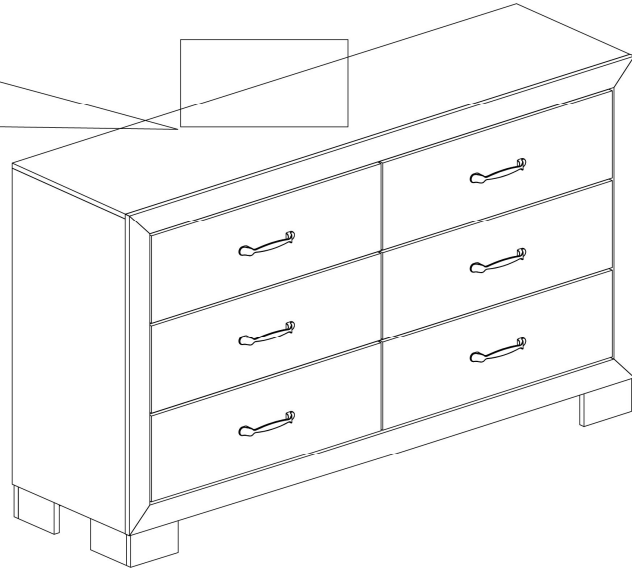
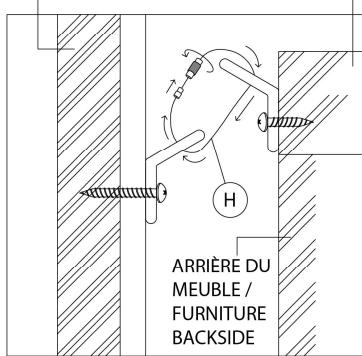

ÉTAPE / STEP 4

